



DOP-W High Color • Wide Screen • User-Friendly HMI Products

DOP-W105B / DOP-W127B / DOP-W157B Instruction Sheet

(1) Preface

Thank you for purchasing DELTA's DOP-W series. This instruction sheet will be helpful in the installation, wiring and inspection of Delta HMI. Before using the product, please read this instruction sheet to ensure correct use. You should thoroughly understand all safety precautions before proceeding with the installation, wiring and operation. Place this instruction sheet in a safe location for future reference. Please observe the following precautions:

- Install the product in a clean and dry location free from corrosive and inflammable gases or liquids.
- Ensure that all wiring instructions and recommendations are followed.
- Ensure that HMI is correctly connected to a ground. The grounding method must comply with the electrical standard of the country (Please refer to NFPA 70: National Electrical Code, 2005 Ed.).
- Do not disassemble HMI, modify or remove wiring when power is applied to HMI.
- Do not touch the power supply during operation. Otherwise, it may cause electric shock.

If you have any questions during operation, please contact our local distributors or Delta sales representatives.

The content of this instruction sheet may be revised without prior notice. Please consult our distributors or download the most updated version at <http://www.delta.com.tw/ia>

(2) Safety Precautions

Carefully note and observe the following safety precautions when receiving, inspecting, installing, operating, maintaining and troubleshooting. The following words, DANGER, WARNING and STOP are used to mark safety precautions when using the Delta's HMI product. Failure to observe these precautions may void the warranty!

Installation

- Comply with quick start for installation. Otherwise it may cause equipment damage.
- Do not install the product in a location that is outside the stated specification for the HMI. Failure to observe this caution may result in electric shock, fire, or explosion.
- Do not install the product in a location where temperatures will exceed specification for the HMI. Failure to observe this caution may result in abnormal operation or damage the product.
- Please note that this equipment has obtained EMC registration for commercial use. In the event that it has been mistakenly sold or purchased, please exchange it for equipment certified for home use.
- Do not use this product as an alarm device for disaster early warning that may result in personal injury, equipment damage, or system emergency stop.

Wiring

- Connect the ground terminals to a class-3 ground (Ground resistance should not exceed 100Ω). Improper grounding may result in communication error, electric shock or fire.

Operation

- The users should use Delta editing software, DOPSoft to perform editing in Delta's HMI product. To perform editing and confirming HMI programs without using Delta editing software, DOPSoft in Delta's HMI product may result in abnormal operation.
- To prevent the personal injury and equipment damage, when designing HMI programs, please ensure that a communication error occurred between Delta's HMI product and the connecting controller or equipment will not result in system failure or malfunction.
- Please be sure to backup the screen data and HMI programs in case they are lost, accidentally deleted or worse.
- Do not modify wiring during operation. Otherwise it may result in electric shock or personal injury.
- Never use a hard or pointed object to hit or strike the screen as doing this may damage the screen and let the screen has not respond at all, and then cause HMI to work abnormally.

Maintenance and Inspection

- Do not touch any internal or exposed parts of the HMI as electrical shock may result.
- Do not remove operation panel while power is on. Otherwise electrical shock may result.
- Wait at least 10 minutes after power has been removed before touching any HMI terminals or performing any wiring and/or inspection as an electrical charge may still remain in the HMI with hazardous voltages even after power has been removed.
- Turn the power off before changing backup battery and check system settings after finishing change. (all data will be cleared after changing battery).
- Be sure the ventilation holes are not obstructed during operation. Otherwise malfunction may result due to bad ventilation or overheating troubles.

Wiring Method

- Do not use a voltage that will exceed specification for the HMI. Failure to observe this caution may result in electric shock or fire.
- Remove the terminal block from the HMI before wiring.
- Insert only one wire into one terminal on the terminal block.
- If the wiring is in error, perform the wiring again with proper tools. Never use force to remove the terminals or wires. Otherwise, it may result in malfunction or damage.

Communication Wiring



- Comply with communication wiring specification for wiring.
- Wiring length should comply with the stated specification for the HMI.
- Proper grounding to avoid bad communication quality.
- To avoid noise and interference, the communication cable, all power cables, and motor power cable should be placed in separate conduits.

(3) Pin Definition of Serial Communication DOP-W105B / DOP-W127B / DOP-W157B COM2 Port

COM Port	PIN	MODE1	MODE2	MODE3
		RS-232	RS-422	RS-485
	1		TXD+	D+
	2	RXD		
	3	TXD		
	4		RXD+	
	5	SGND	SGND	SGND
	6		TXD-	D-
	7	RTS		
	8	CTS		
	9		RXD-	

Note1: Blank = No Connection.

DOP-W105B / DOP-W127B / DOP-W157B COM3 Port

COM Port	PIN	MODE1	MODE2	MODE3
		RS-232	RS-422	RS-485
	1		TXD+	D+
	2	RXD		
	3	TXD		
	4		RXD+	
	5	SGND	SGND	SGND
	6		TXD-	D-
	7	RTS		
	8	CTS		
	9		RXD-	

Note1: Blank = No Connection.

(4) Parts Names

DOP-W105B (Front View)

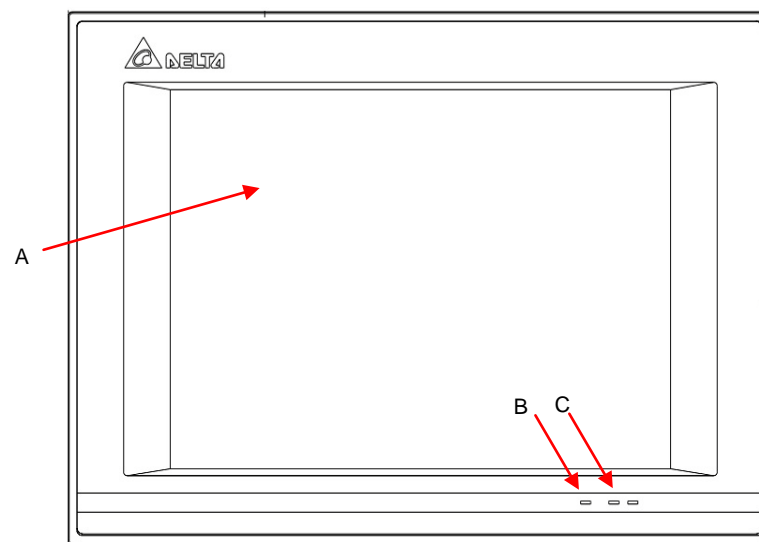

A	Touch Screen / Display	B	Power LED Indicator
C	Operation LED Indicator / Alarm LED Indicator		

DOP-W105B (Rear View)

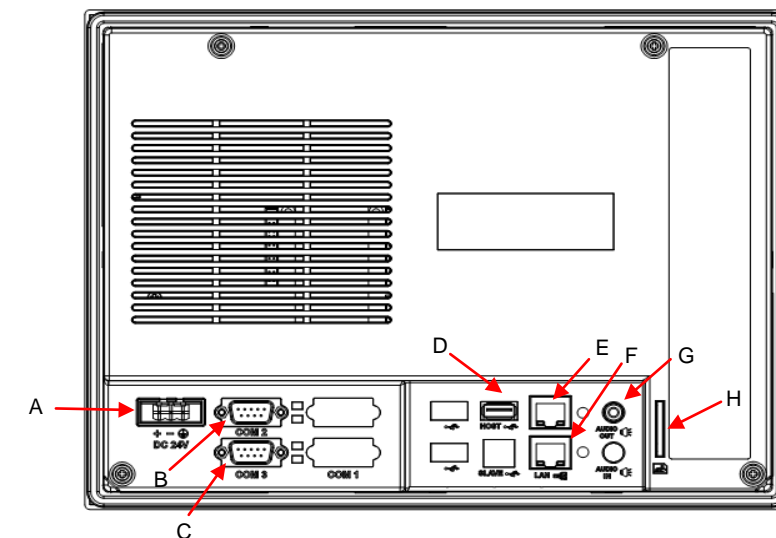

A	Power Input Terminal	B	COM2
C	COM3	D	USB Host
E	Ethernet LAN1	F	Ethernet LAN2
G	Audio	H	SD

DOP-W127B / DOP-W157B (Front View)

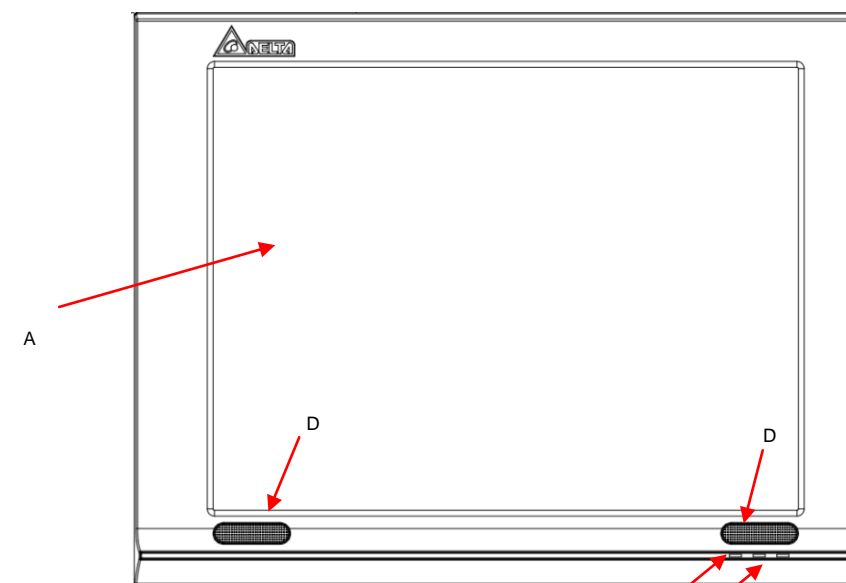

A	Touch Screen / Display	B	Power LED Indicator
C	Operation LED Indicator / Alarm LED Indicator	D	1.5W Built In Speaker

DOP-W127B (Rear View)

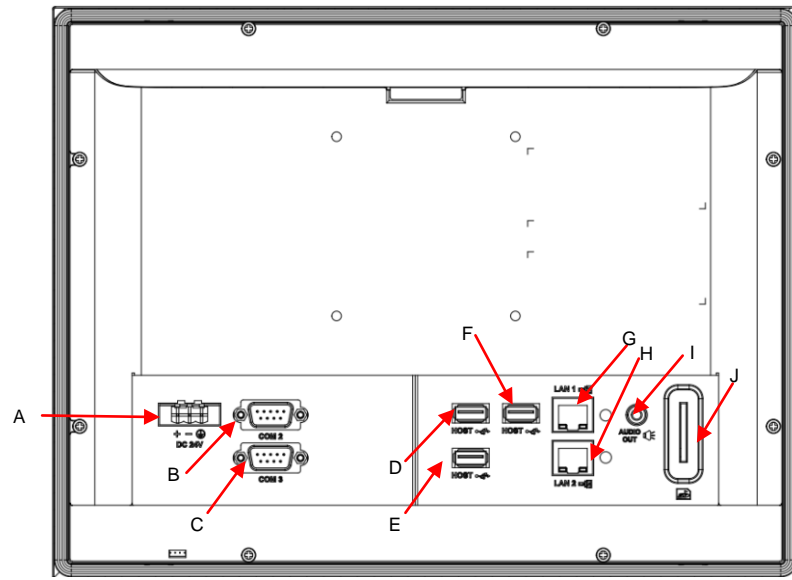

A	Power Input Terminal	B	COM2
C	COM3	D	USB Host
E	USB Host	F	USB Host
G	Ethernet LAN1	H	Ethernet LAN2
I	Audio	J	SD

DOP-W157B (Rear View)

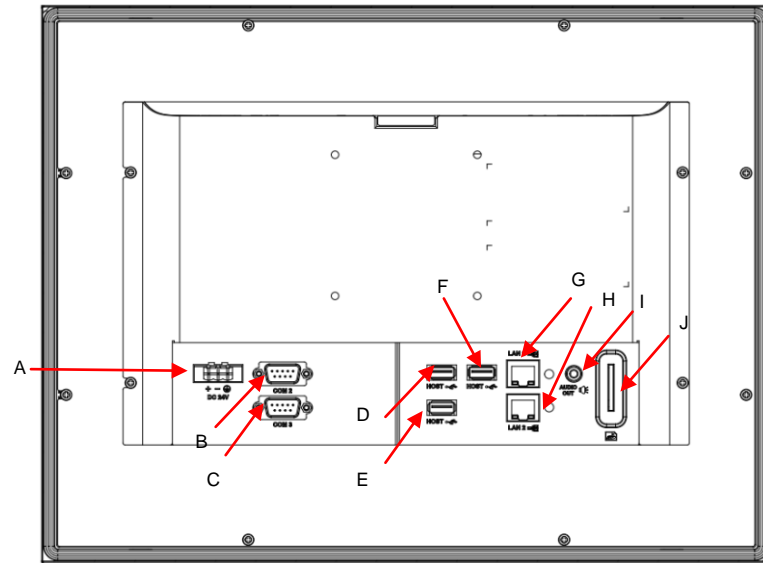

A	Power Input Terminal	B	COM2
C	COM3	D	USB Host
E	USB Host	F	USB Host
G	Ethernet LAN1	H	Ethernet LAN2
I	Audio	J	SD

(5) Dimensions

DOP-W105B

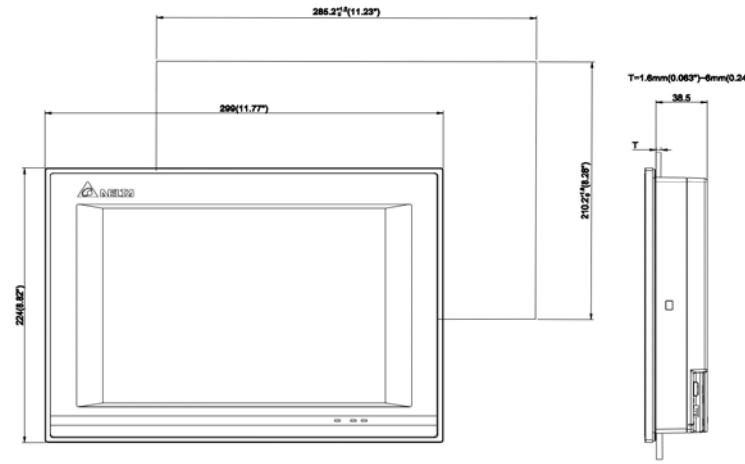

DOP-W127B

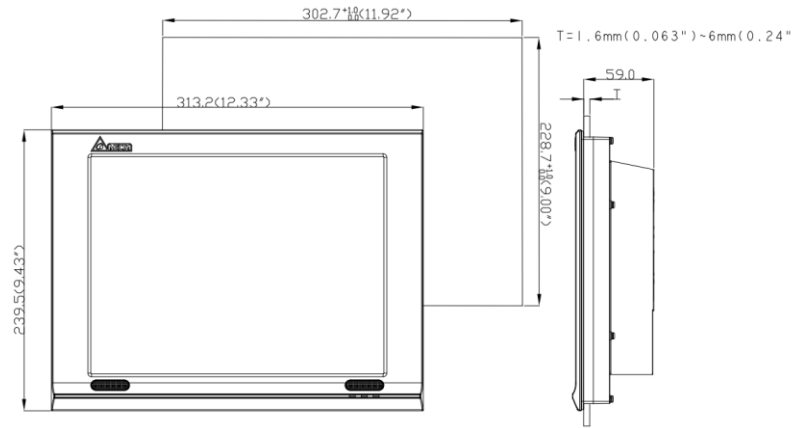

DOP-W157B

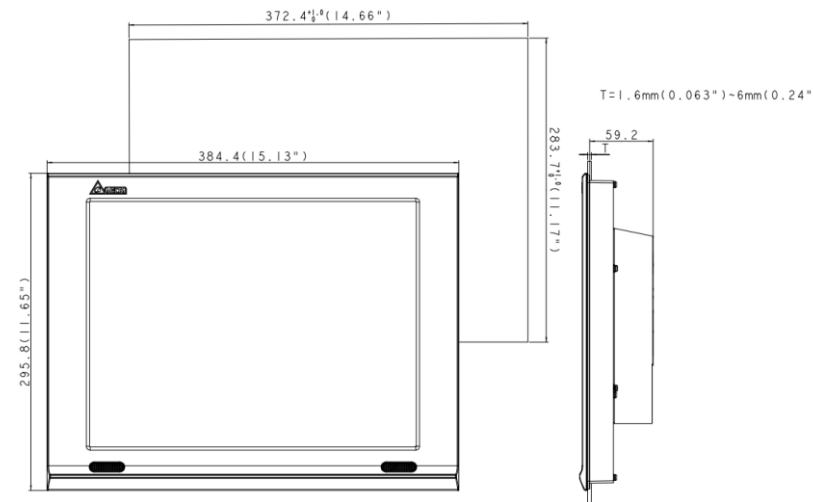

(6) Specifications

	MODEL	DOP-W105B	DOP-W127B	DOP-W157B
LCD MODULE	Display Type	10.4" TFT LCD	12.1" TFT LCD	15" TFT LCD
	Resolution	800 x 600 pixels	1024 x 768 pixels	
	Backlight	LED Back Light		
	Backlight Life	less than 10,000 hours	less than 30,000 hours	less than 80,000 hours
	Luminance	300 cd/m ² (Typ.)	500 cd/m ² (Typ.)	450 cd/m ² (Typ.)
	Display Size	211.20 x 158.40mm	245.76*184.32mm	304.1*228.1mm
Operation System	Windows® CE 6.0			
MCU	ARM Cortex-A8 (1GHz)			
NOR Flash ROM	SLC NAND Flash ROM 256 MB			
SDRAM	256 Mbytes			
Backup Memory	800000 numbers of data (alarm data + historical data)			
Touch Screen Interface	4-wire resistive touch screen > 10,000,000 operated			
Buzzer	Multi-Tone Frequency (2K ~ 4K Hz) / 80dB			

MODEL	DOP-W105B	DOP-W127B	DOP-W157B
Audio Output	I2S Decode, Stereo Headphone jack only	I2S Decode, Stereo Headphone jack + Built in 1.5W Speaker	
USB	3 USB Host Ver 2.0		
SD	SDHC x 1		
Serial COM Port	COM1	N/A	
	COM2	RS-232 / RS-422 / RS-485 (has built-in isolated power circuit ^(Note 1))	
	COM3	RS-232 / RS-422 / RS-485 (has built-in isolated power circuit ^(Note 1))	
Ethernet	2 Ports IEEE 802.3(10BASE-T) IEEE 802.3u(100BASE-TX) IEEE 802.3x (Full Duplex and flow control)		
Perpetual Calendar (RTC)	Built-in		
Cooling Method	Natural air circulation		
Safety Approval	CE / UL ^(Note 3)		
Waterproof Degree	IP65 ^(Note 3)		
Operation Voltage ^(Note 2)	DC +24V (-10% ~ +15%) (please use isolated power supply)		
Voltage Endurance	AC500V for 1 minute (between charging (DC24V terminal) and FG terminals)		
Power Consumption ^(Note 2)	13.5W (Max)	18.5W (Max)	21.6W (Max)
Backup Battery	uses a gold-capacitor instead of a battery, no need replacement of batteries		
Backup Battery Life	It can keep the RTC work at least seven days under the working environment where the conditions do not exceed the specifications for DOP-W series.		
Operation Temperature	0°C ~ 50°C		
Storage Temperature	-20°C ~ +60°C		
Ambient Humidity	10% ~ 90% RH [0 ~ 40°C], 10% ~ 55% RH [41 ~ 50°C] Pollution Degree 2		
Noise Immunity	DOP-W105B / DOP-W127B / DOP-W157B		
	ESD (IEC 61131-2, IEC 61000-4-2)	±6KV Contact Discharge ±10KV Air Discharge	
	EFT (IEC 61131-2, IEC 61000-4-4)	Power Line: ±1KV (Class A) Communication I/O: ±500V (Class A)	
	Surge (IEC 61132-2, IEC 61000-4-5)	Power line ±1KV DM Series Port ±500V CM Ethernet ±500KV CM	
	RS (IEC 61131-2, IEC 61000-4-3)	80MHz ~ 1GHz, 10V/m. 1.4GHz ~ 2.0GHz, 10V/m	
	CS (EN 61000-4-6, IEC61131-2 9.10)	150kHz ~ 80MHz, 3V/m	
	Vibration	IEC 61131-2 compliant 5Hz ≤ f < 8.3Hz = Continuous: 3.5mm, 8.3Hz ≤ f ≤ 150Hz = Continuous: 1.0g	
Shock	IEC 60068-2-27 compliant 15g peak for 11 ms duration, X, Y, Z directions for 6 times		
Dimensions (W) x (H) x (D) mm	299 x 224 x 46.8	313 x 239.5 x 67.5	384.4*295.8*67.8
Panel Cutout (W) x (H) mm	285.2 x 210.2	302.7 x 228.7	372.4*283.7
Weight	Approx. 1750g	Approx. 2830g	Approx. 3880g

NOTE

- 1) The withstand voltage of the isolated power circuit is 1500V peak for 1 minute.
- 2) The value of the power consumption indicates the electrical power consumed by HMI only without connecting to any peripheral devices. In order to ensure the normal operation, it is recommended to use a power supply which the capacity is 1.5 ~ 2 times the value of the power consumption.
- 3) Some models are in the process of application to UL and KCC certification. For more information, please consult our distributors.
- 4) The content of this instruction sheet may be revised without prior notice. Please consult our distributors or download the most updated version at <http://www.delta.com.tw/ia>.

DOP-W

Yüksek Renk · Geniş Ekran ·
Kullanımı Kolay HMI Ürünleri

DOP-W105B / DOP-127B / DOP-W157B Bilgi Dökümanı

(1) Önsöz

DELTA'nın DOP-W serisi operatör panellerini seçtiğiniz için teşekkürler. Bu bilgi dokümanı Delta HMI kurulum, bağlantı, bakım ve kontrolünde kullanıcıya yardımcı olacaktır. Doğru kullanım için ürün kullanmadan önce bu dokümanı mutlaka okuyunuz. Kurulum, bağlantı ve çalışma yapmadan önce güvenlik uyarılarını tamamen anladığınızdan emin olunuz. Bu dokümanı daha sonra da kullanmak için iyi muhafaza ediniz. Lütfen aşağıdaki güvenlik uyarılarına dikkat ediniz:

- Ürünün kurulumunu yanıcı gaz ve sıvılardan uzak kuru ve temiz ortamlara yapınız.
- Bağlantıları yaparken tüm bağlantı kurallarının sağlandığından emin olunuz.
- HMI'nin toprak bağlantısının doğru yapıldığından emin olunuz. Topraklama metodunun ürünün kurulduğu ülke standartlarına uygun olduğuna emin olunuz (NFPA 70: National Electrical Code, 2005 Ed.).
- HMI enerjili iken kablo bağlantısı yapmayınız ya da sökmeyiniz.
- Çalışma sırasında enerji besleme terminallerine dokunmayınız. Aksi halde elektrik şoku olabilir.

Ürünün kullanımı ile ilgili sorularınız için, lütfen teknik servisimize bağlantıya geçiniz.

Herhangi bir ihbara gerek kalmaksızın bu bilgi dokümanının içeriği değiştirilebilir. Güncellenmiş versiyonu elde etmek için teknik servise danışabilir veya internet adresinden indirebilirsiniz. <http://www.delta.com.tw/ia>

(2) Güvenlik Uyarıları

Ürünü alırken, kontrol ederken, kurulumunu yaparken, çalıştırırken, bakım ve arıza teşhisi yaparken aşağıdaki güvenlik uyarılarına dikkat ediniz. DANGER, WARNING ve STOP başlıkları DELTA HMI ürününü kullanırken yapılması gerekenleri dikkat çekmek için kullanılmıştır. Ürünün garantisini muhafaza etmek için bu uyarılara mutlaka dikkat ediniz!

Kurulum



- Kurulumu doküman da belirtildiği gibi yapınız. Aksi halde ürün zarar görebilir.
- Operatör panelini doküman da belirtilen ortam değerlerinin dışında kurulumunu yapmayınız. Aksi halde elektrik şoku, yangın ya da kişisel zararlara sebep olabilir.
- HMI ürününü bu doküman da belirtilen sıcaklık değerleri dışında bir ortama kurulumunu yapmayınız. Aksi halde anormal çalışma olabilir veya ürün zarar görebilir.
- DELTA HMI ürünleri endüstriyel uygulamalarda kullanılmak amacıyla tasarlanmıştır.
- Bu ürün endüstriyel otomasyon uygulamaları için geliştirilmiştir. Farklı bir amaç için (erken uyarı alarm sistemleri gibi) kullanılması tavsiye edilmez.

Bağlantı



- Toprak terminallerini class-3 topraklama yapınız. (Topraklama direnci 100Ω' u şamamalıdır). Yanlış yapılan topraklama bağlantısı haberleşme hatasına, elektrik şokuna ve yangına sebep olabilir.

Çalışma



- DELTA'nın HMI ürünlerini programlamak için DOPSoft yazılımı kullanılmalıdır. DELTA HMI ürünlerini programlamak için DOPSoft yazılımı dışında bir yazılım kullanılması durumunda HMI çalışmasında problem meydana gelebilir.
- Kişisel tehlikeleri ve ürünün zarar görmesini önlemek için, HMI programları oluştururken, DELTA HMI ile ona bağlı kontrol ünitesi veya donanım arasında haberleşme hatası olduğunda sistemin zarar görmemesi ve bozulmaması için gerekli önlemler alınmalıdır.
- Kaza ile silinme, kaybolma... vb durumlara karşı ekran datalarının ve HMI programlarının yedeğini aldığınızda emin olunuz.



- Çalışma sırasında kablo bağlantılarını değiştirmeyiniz. Aksi halde elektrik şokuna veya kişisel zararlara sebep olabilir.
- Dokunmatik ekrana sert ve sivri nesnelere dokunarak basmayınız. Aksi halde HMI ekranı zarar görebilir ve HMI'nin anormal çalışmasına sebep olabilir.

Bakım ve Kontroller



- HMI içindeki devre elemanlarına dokunmayınız aksi halde elektrik şoku meydana gelebilir.
- Enerjili iken operatör panelinin bağlantılarına müdahale etmeyiniz. Aksi halde elektrik şoku meydana gelebilir.
- HMI enerjisi kesildikten sonra HMI üzerinde tehlikeli seviyede elektrik şarj voltajı kalabileceğinden ürüne dokunmadan ve bağlantılara müdahale etmeden önce en az 10 dakika beklenilmesi tavsiye edilir.
- Pili değiştirmeden önce ürünün enerjisini kesiniz ve pili değiştirdikten sonra sistem ayarlarını kontrol ediniz. (Pil değiştirildikten sonra tüm datalar silinecektir).
- Çalışma sırasında havalandırma deliklerinin tıkalı olmadığından emin olunuz. Aksi halde kötü havalandırmadan veya aşırı sıcaklıktan dolayı ürün zarar görebilir.

Bağlantı Metodu



- HMI için bu dokümanda belirtilen değerlerin dışında voltaj uygulamayınız. Aksi halde elektrik şoku veya yangına sebep olabilir.
- Kablo bağlantısı yapmadan önce terminal bloğunu HMI' dan ayırınız.
- Terminal bloğundaki her bir terminale sadece tek bir kablo bağlayınız.
- Eğer bağlantıda hata varsa, bağlantıyı uygun aletleri kullanarak tekrar yapınız. Terminal ya da kabloları sökmek için darbe uygulamayınız. Aksi halde ürün zarar görebilir.

Haberleşme Bağlantısı



- Haberleşme bağlantısını doküman da belirtildiği gibi yapınız.
- HMI Kablo uzunlukları doküman da belirtildiği gibi olmalıdır.
- Haberleşmenin kalitesini arttırmak için düzgün topraklama yapınız.
- Gürültü ve parazitten kaçınmak için, haberleşme kablosu, tüm enerji besleme kabloları ve motor kablolarından ayrı olmalıdır.

(3) Seri Haberleşme Pin Açıklaması

DOP-W105B / DOP-127B / DOP-W157B COM2 Port

COM Port	PIN	MOD1	MOD2	MOD3
		RS-232	RS-422	RS-485
	1		TXD+	D+
	2	RXD		
	3	TXD		
	4		RXD+	
	5	SGND	SGND	SGND
	6		TXD-	D-
	7	RTS		
	8	CTS		
	9		RXD-	

Not1: Boş = Bağlantı yapılmaz.

DOP-W105B / DOP-127B / DOP-W157B COM3 Port

COM Port	PIN	MOD1	MOD2	MOD3
		RS-232	RS-422	RS-485
	1		TXD+	D+
	2	RXD		
	3	TXD		
	4		RXD+	
	5	SGND	SGND	SGND
	6		TXD-	D-
	7	RTS		
	8	CTS		
	9		RXD-	

Not1: Boş = Bağlantı yapılmaz.

(4) Parça Adları

DOP-W105B (Ön Görünüm)

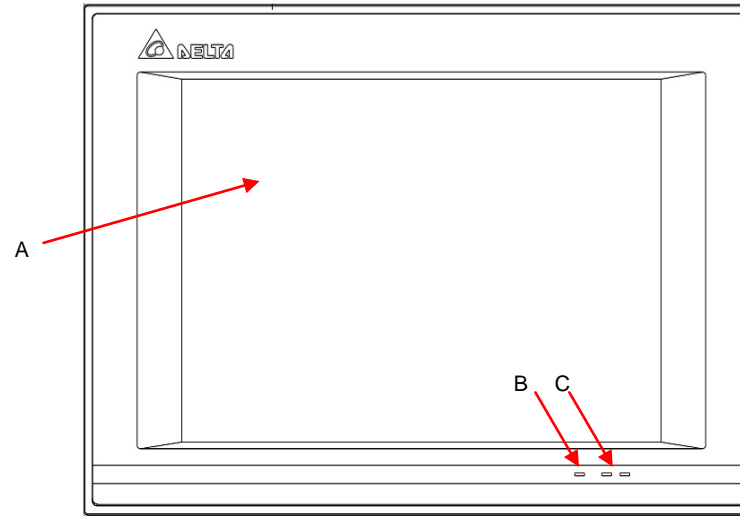

A	Dokunmatik Ekran / Display	B	Power LED Göstergesi
C	Çalışma LED Göstergesi / Alarm LED Göstergesi		

DOP-W105B (Arka Görünüm)

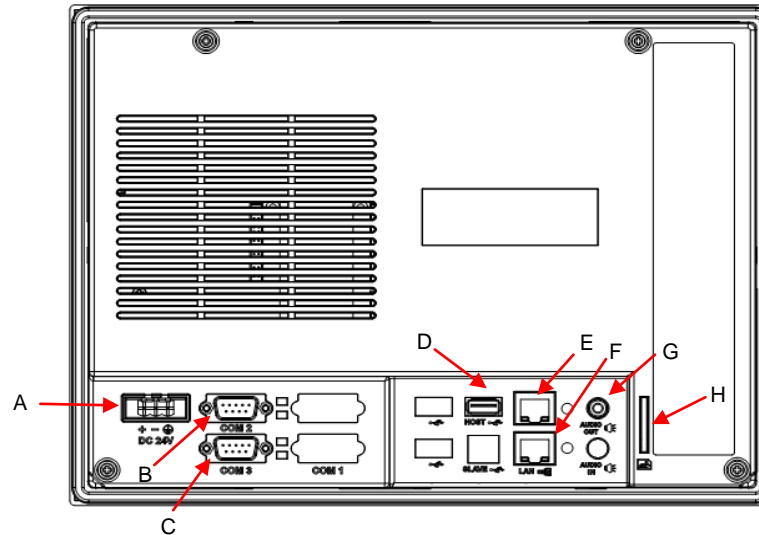

A	Power Giriş Terminali	B	COM2
C	COM3	D	USB Host
E	Ethernet LAN1	F	Ethernet LAN2
G	Audio	H	SD

DOP-W127B / DOP-W157B (Ön Görünüm)

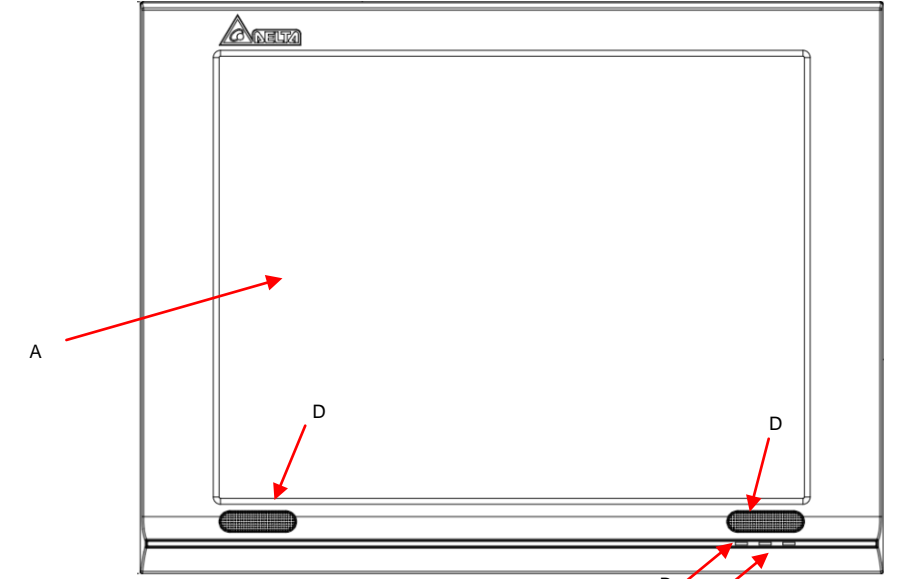

A	Dokunmatik Ekran / Display	B	Power LED Göstergesi
C	Çalışma LED Göstergesi / Alarm LED Göstergesi	D	Dahili 1.5W Hoparlör

DOP-W127B (Arka Görünüm)

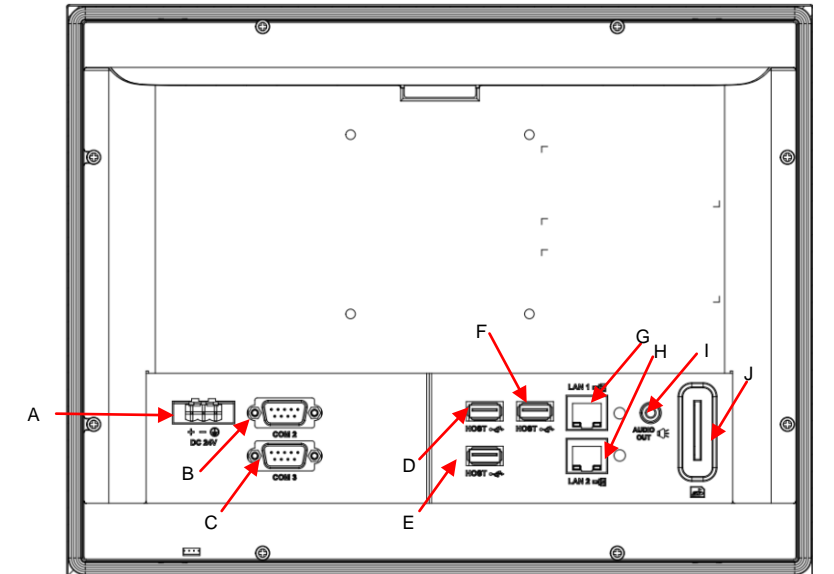

A	Power Giriş Terminali	B	COM2
C	COM3	D	USB Host
E	USB Host	F	USB Host
G	Ethernet LAN1	H	Ethernet LAN2
I	Audio	J	SD

DOP-W157B (Arka Görünüm)

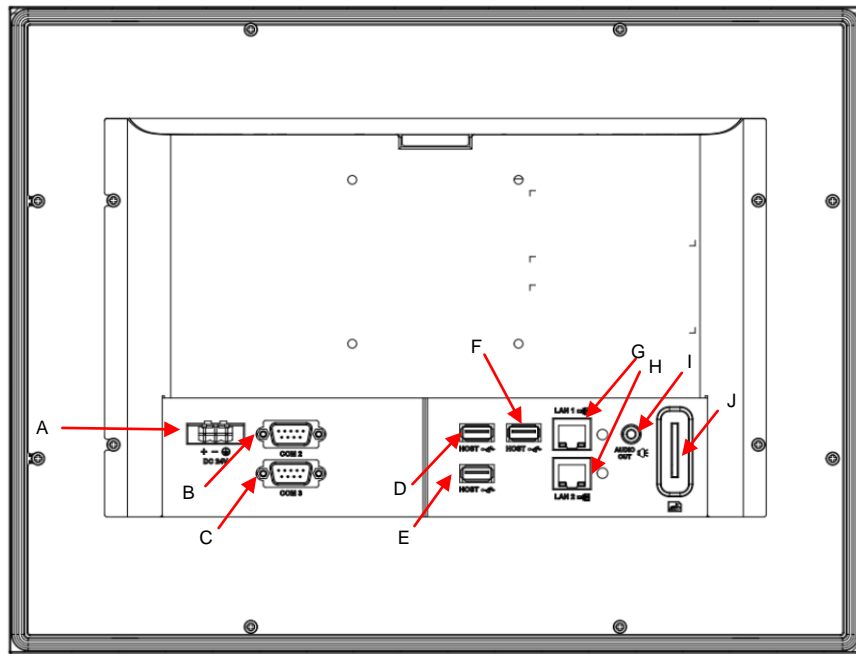

A	Power Giriş Terminali	B	COM2
C	COM3	D	USB Host
E	USB Host	F	USB Host
G	Ethernet LAN1	H	Ethernet LAN2
I	Audio	J	SD

(5) Ölçüler

DOP-W105B

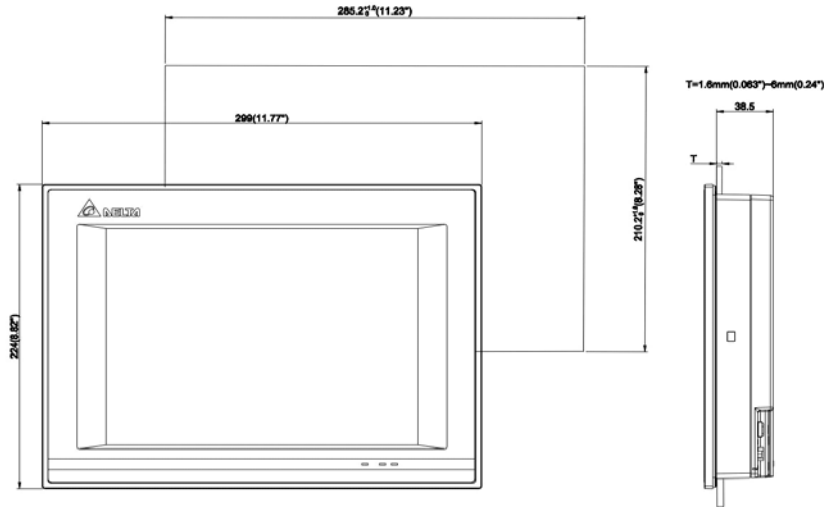

DOP-W127B

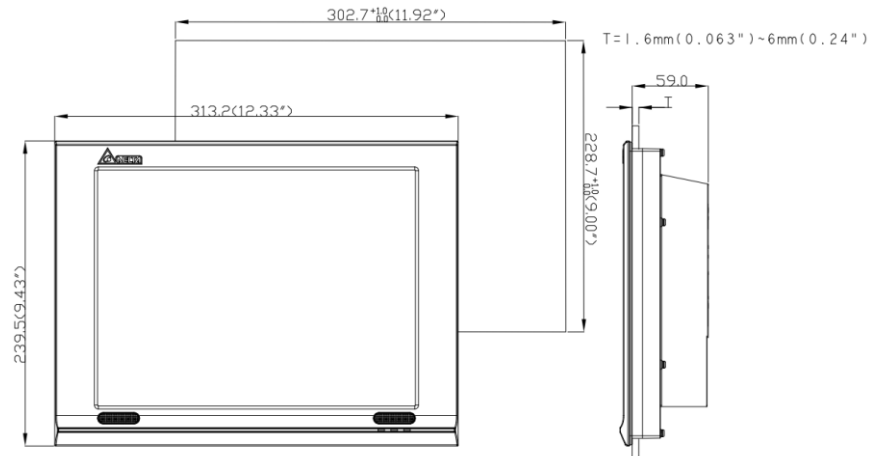

DOP-W157B

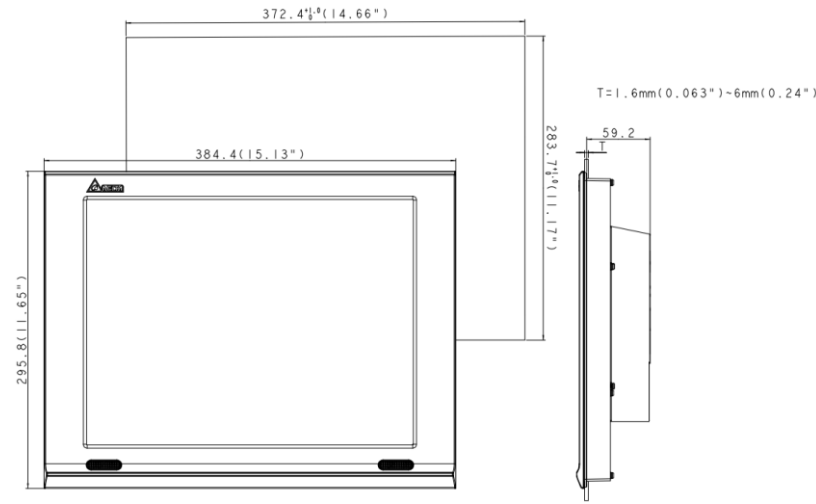

(6) Özellikler

MODEL	DOP-W105B	DOP-W127B	DOP-W157B	
LCD MODULÜ	Display Tipi	10.4" TFT LCD	12.1" TFT LCD	15" TFT LCD
	Çözünürlük	800 x 600 pixel	1024 x 768 pixel	
	Arka Işık	LED Arka Işık		
	Arka Işık Ömrü	10,000 saatten az	30,000 saatten az	80,000 saatten az
	Parlaklık	300 cd/m ² (Tipik.)	500 cd/m ² (Tipik.)	450 cd/m ² (Tipik.)
	Display Ölçüsü	211.20 x 158.40mm	245.76*184.32mm	304.1*228.1mm
	İşletim Sistemi	Windows® CE 6.0		
MCU	ARM Cortex-A8 (1GHz)			
NOR Flash ROM	SLC NAND Flash ROM 256 MB			
SDRAM	256 Mbyte			
Backup Hafıza	800000 adet data (alarm data + geçmiş data kayıt)			
Dokunmatik Ekran Arabirimi	4-kablo rezistif dokunmatik ekran > 10,000,000 çalışma			
Buzzer	Multi-Tone Frekansı (2K ~ 4kHz) / 80dB			
Audio Çıkış	I2S Dekoder , Stereo Kulaklık Girişi terminali	I2S Dekoder , Stereo Kulaklık Girişi + Dahili 1.5W Hoparlör		
USB	3 USB Host Ver 2.0			
SD	SDHC x 1			
Seri COM Port	COM1	N/A		
	COM2	RS-232 / RS-422 / RS-485 (dahili izoleli güç devresi mevcuttur ^(Not 1))		
	COM3	RS-232 / RS-422 / RS-485 (dahili izoleli güç devresi mevcuttur ^(Not 1))		
Ethernet	2 Port IEEE 802.3(10BASE-T) IEEE 802.3u(100BASE-TX) IEEE 802.3x (Full Duplex ve akış denetimi)			
Gerçek Zaman Saati (RTC)	Dahili			
Soğutma Metodu	Doğal hava sirkülasyonu			
Güvenlik Onayı	CE / UL ^(Not 3)			
Su Geçirmezlik Derecesi	IP65 ^(Not 3)			
Çalışma Voltajı ^(Not2)	DC +24V (-10% ~ +15%) (lütfen izoleli güç kaynağı kullanın)			
Voltaj Dayanımı	1 dakika için AC500V (besleme (DC24V terminal) ve FG terminalleri arasında)			
Güç Tüketimi ^(Not 2)	13.5W (Max)	18.5W (Max)	21.6W (Max)	
Backup Pili	Pil yerine gold-kapasitör kullanır, pil değiştirme gerektirmemektedir.			
Backup Pil Ömrü	DOP-W serileri için dokümanda belirtilen ortam koşulları altında çalışmada en az yedi gün RTC çalışmasını muhafaza eder.			
Çalışma Sıcaklığı	0°C ~ 50°C			
Saklama Sıcaklığı	-20°C ~ +60°C			
Rutubet Oranı	10% ~ 90% RH [0 ~ 40°C], 10% ~ 55% RH [41 ~ 50°C] Kirlenme Derecesi 2			

MODEL	DOP-W105B	DOP-W127B	DOP-W157B	
Gürültü Başışıklığı	DOP-W105B / DOP-W127B / DOP-W157B			
	ESD (IEC 61131-2, IEC 61000-4-2)	±6KV Contact Discharge ±10KV Air Discharge		
	EFT (IEC 61131-2, IEC 61000-4-4)	Power Line:±1KV (Class A) Communication I/O: ±500V (Class A)		
	Surge (IEC 61132-2, IEC 61000-4-5)	Power line ±1KV DM		
		Series Port ±500V CM Ethernet ±500KV CM		
	RS (IEC 61131-2, IEC 61000-4-3)	80MHz ~ 1GHz, 10V/m. 1.4GHz ~ 2.0GHz, 10V/m		
	CS (EN 61000-4-6, IEC61131-2 9.10)	150kHz ~ 80MHz, 3V/m		
	Titreşim	IEC 61131-2 uyumlu 5Hz ≤ f < 8.3Hz = Sürekli: 3.5mm, 8.3Hz ≤ f ≤ 150Hz = Sürekli: 1.0g		
	Şok	IEC 60068-2-27 uyumlu 11ms süresince 15g pik, X, Y, Z yönünde 6 defa		
	Ölçüler (W) x (H) x (D) mm	299 x 224 x 46.8	313 x 239.5 x 67.5	384.4*295.8*67.8
Panel Kesim Ölçüsü (W) x (H) mm	285.2 x 210.2	302.7 x 228.7	372.4*283.7	
Ağırlık	Yaklaşık. 1750g	Yaklaşık. 2830g	Yaklaşık. 3880g	

NOTE

- 1) İzole edilmiş güç devresinin dayanma voltajı 1 dakika için 1500V pik değerindedir.
- 2) Güç tüketimi HMI ünitesinin hiç bir cihaza bağlı olmadan boş olarak tükettiği gücü gösterir. Normal çalışmada HMI'nın boş iken tükettiği gücün 1.5 veya 2 katı güç verebilen besleme kaynağı kullanılması tavsiye edilir.
- 3) Bazı modeller UL ve KCC başvuru sürecindedir. Daha fazla bilgi için firmamız ile temasa geçiniz.
- 4) Herhangi bir ihbar olmadan bu dokümanın içeriği değiştirilebilir. En son güncellenmiş halini firmamızdan talep edebilir ya da aşağıdaki link adresinden indirebilirsiniz <http://www.delta.com.tw/ia>.

TÜRKİYE İTHALATÇI FİRMA

FABRİKA AYGITLARI SİSTEM TEKNOLOJİSİ BİLGİSAYAR YAZILIM VE ELEKTRONİK PAZARLAMA İTHALAT İHRACAT ANONİM ŞİRKETİ

FAST Plaza Küçükbakkalköy Mh. Dereyolu Sk. No:4
ATAŞEHİR / İSTANBUL
T: +(90) 216 574 94 34 F: +(90) 216 574 16 60
E: satis@fastltd.net W: www.fastltd.net

Üretici Firma Delta Electronics, Inc.

Taiwan
31-1 Xingbang Road,
Guishan Industrial Zone,
Taoyuan County 33370,
Taiwan
TEL: 886-3-362-6301 / FAX: 886-3-362-7267

China
1688 Jiangxing East Road,
Wujiang Economic Development Zone
Wujiang City, Jiang Su Province,
People's Republic of China (Post code: 215200)
TEL: 86-512-6340-3008 / FAX: 86-769-6340-7290



DOP-W

高彩・寬螢幕・友善人機介面

DOP-W105B / DOP-W127B / DOP-W157B 安裝說明

(1) 一般注意事項

感謝您使用本產品。本人機介面安裝說明書提供 DOP-W 系列人機介面的相關資訊。在使用之前，請您仔細詳讀本說明書以確保使用上的正確。此外，請妥善將其放置在明顯的地點以便隨時查閱。下列事項在您尚未讀完本說明書前，請務必遵守：

- 安裝的環境必須沒有水氣、腐蝕性氣體及可燃性氣體。
- 接線時，請依接線圖說明施工。
- 接地工程必須確實實施，接地時須遵照國家現行相關電工法規之規定施行（請參考 NFPA 70: National Electrical Code, 2005 Ed.）。
- 在通電時，請勿拆解人機介面或更改配線。
- 在通電運作時，請勿接觸電源處，以免觸電。

如果您在使用上仍有問題，請洽詢經銷商或者本公司客服中心。由於產品精益求精，當內容規格有所修正時，請洽詢代理商或至台達網站 (<http://www.delta.com.tw/ia>) 下載最新版本。

(2) 安全注意事項

安裝、配線、操作、維護及檢查時，應隨時注意以下安全注意事項。

安裝注意

- ▶ 依照手冊指定的方式安裝人機介面，否則可能導致設備損壞。
- ▶ 禁止將本產品暴露在有水氣、腐蝕性氣體、可燃性氣體等物質的場所下使用，否則可能會造成觸電、火災或爆炸。
- ▶ 請勿將人機介面安裝在超過規格範圍的溫度環境中，否則可能造成人機介面無法正常運作或損壞。
- ▶ 本產品為 KCC Class A (商用設備) 產品且通過試驗認證，其設計的目的是在商業或是工業環境使用，而非家庭環境中使用。若在此情況下不小心購買或售出的人機介面產品，請將其更換為有符合 KCC Class B (家用設備) 認證之產品。
- ▶ 請勿將人機介面用於可能會造成人員傷亡、設備損壞或系統停機等警報機台。

配線注意

- ▶ 請將接地端子連接到 class-3 (100Ω 以下) 接地，接地不良可能會造成通訊異常、觸電或火災。

操作注意

- ▶ 人機介面需配合編輯軟體規劃畫面，未經規劃或確認之人機介面可能會導致不正常運轉結果。為避免操作人身傷害或設備損壞，規劃人機畫面時，要確保人機介面及其連接控制器或設備之間的通訊故障不會造成設備功能無法正常運作。
- ▶ 為避免意外遺失程式，請務必備份規劃好的人機介面畫面程式。



- ▶ 不得在開啟電源情況下改變配線，否則可能造成觸電或人員受傷。
- ▶ 請勿以尖銳物品碰觸面板，否則可能導致面板凹陷，進而無法使人機介面正常運作。

保養及檢查

- ▶ 禁止接觸人機介面內部，否則可能會造成觸電。
- ▶ 電源啟動時，禁止拆下人機介面面板，否則可能會造成觸電。
- ▶ 電源關閉 10 分鐘內，不得接觸接線端子，殘餘電壓可能造成觸電。
- ▶ 更換備用電池時，應切斷電源再進行，並在更換後重新檢查系統設定值。
- ▶ 人機介面在操作時，排氣孔不可封住，否則人機容易因為散熱不良而造成故障。

配線方法

- ▶ 請勿使用超過人機介面規格範圍的電壓，否則可能會引起觸電或火災。
- ▶ 配線時請將快速接頭從人機介面的本體上拆下來。
- ▶ 快速接頭的一個電線插入口，請僅插入一根電線。
- ▶ 對於錯誤強行拔出電線的動作，請重新檢查連接電線再啟動。

通訊電路的配線

- ▶ 請依標準規格採用通訊配線線材。
- ▶ 通訊線材長度需在符合規定內。
- ▶ 採用正確的接地迴路，以避免通訊不良。
- ▶ 為防止較大的雜訊干擾引起人機介面無法正常運作，請用單獨的配線槽將人機介面的通訊電纜和所有電源線及馬達動力線分開。

(3) 通訊腳位定義

DOP-W105B / DOP-W127B / DOP-W157B COM2 定義

COM Port 示意圖	腳位	MODE1	MODE2	MODE3
		RS-232	RS-422	RS-485
	1		TXD+	D+
	2	RXD		
	3	TXD		
	4		RXD+	
	5	SGND	SGND	SGND
	6		TXD-	D-
	7	RTS		
	8	CTS		
	9		RXD-	

註 1：空白 = 不需連接

DOP-W105B / DOP-W127B / DOP-W157B COM3 定義

COM Port 示意圖	腳位	MODE1	MODE2	MODE3
		RS-232	RS-422	RS-485
	1		TXD+	D+
	2	RXD		
	3	TXD		
	4		RXD+	
	5	SGND	SGND	SGND
	6		TXD-	D-
	7	RTS		
	8	CTS		
	9		RXD-	

註 1：空白 = 不需連接

(4) 各部位說明

DOP-W105B (正面)

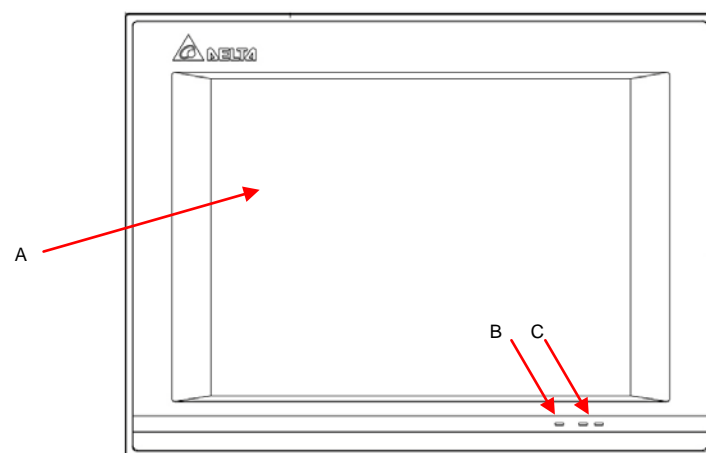

A	操作 / 顯示區域	B	電源指示燈
C	動作指示燈 / 警報指示燈		

DOP-W105B (背面)

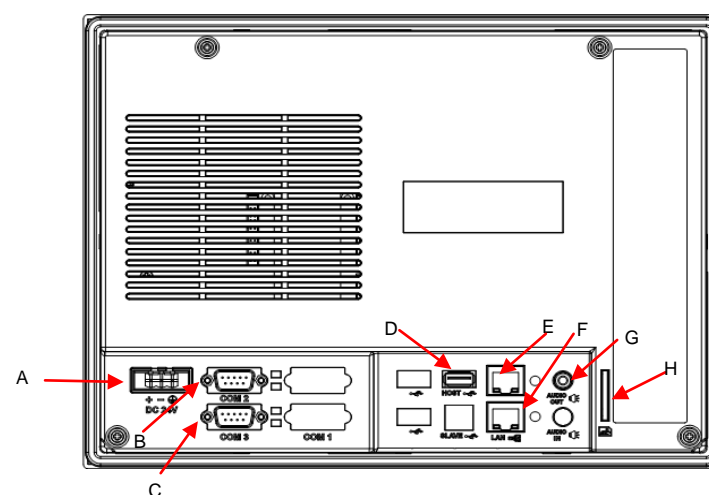

A	電源輸入端子	B	COM2
C	COM3	D	USB Host

E	Ethernet LAN1	F	Ethernet LAN2
G	Audio	H	SD

DOP-W127B / DOP-W157B (正面)

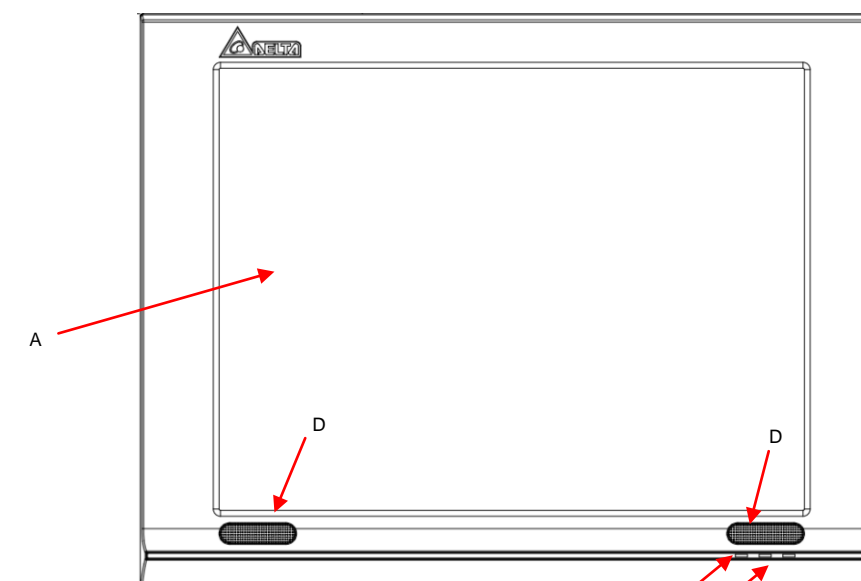

A	操作 / 顯示區域	B	電源指示燈
C	動作指示燈 / 警報指示燈	D	1.5 瓦喇叭

DOP-W127B (背面)

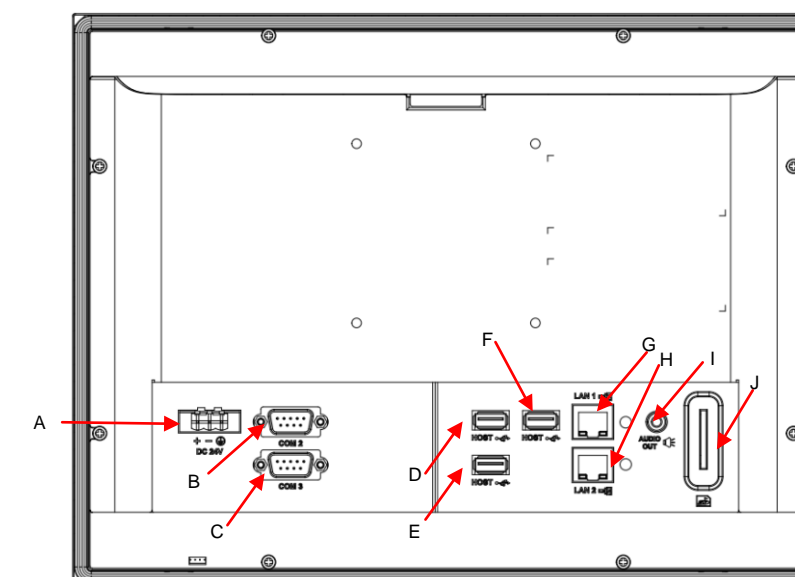

A	電源輸入端子	B	COM2
C	COM3	D	USB Host
E	USB Host	F	USB Host
G	Ethernet LAN1	H	Ethernet LAN2
I	Audio	J	SD

DOP-W157B(背面)

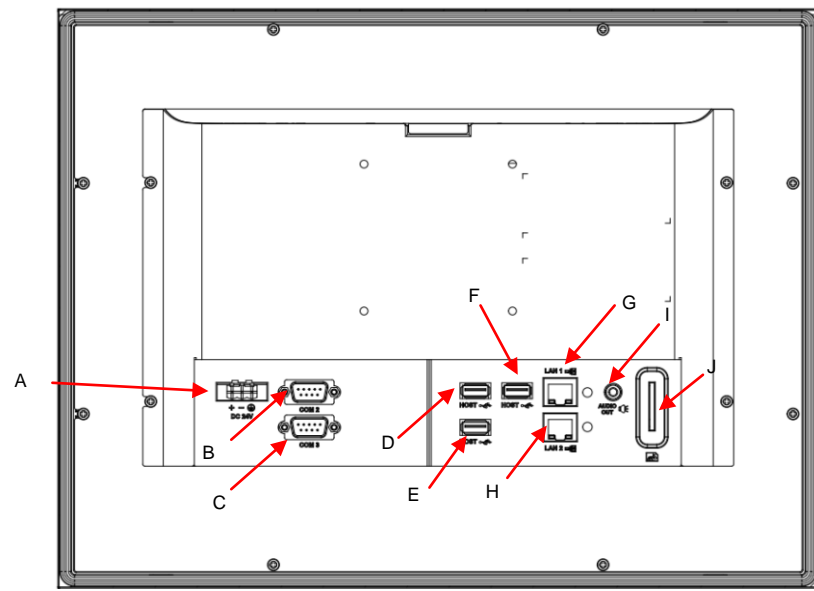

A	電源輸入端子	B	COM2
C	COM3	D	USB Host
E	USB Host	F	USB Host
G	Ethernet LAN1	H	Ethernet LAN2
I	Audio	J	SD

(5) 開孔尺寸

DOP-W105B

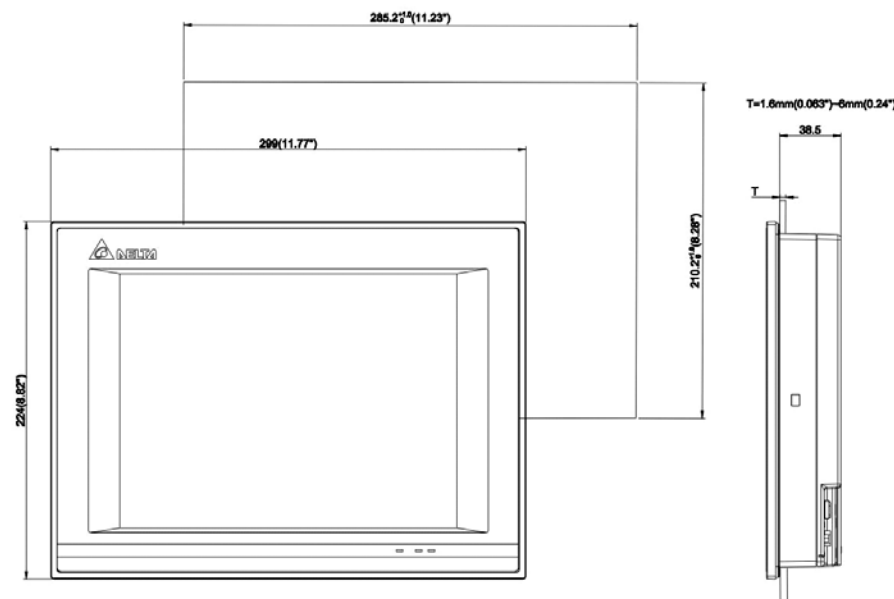

DOP-W127B

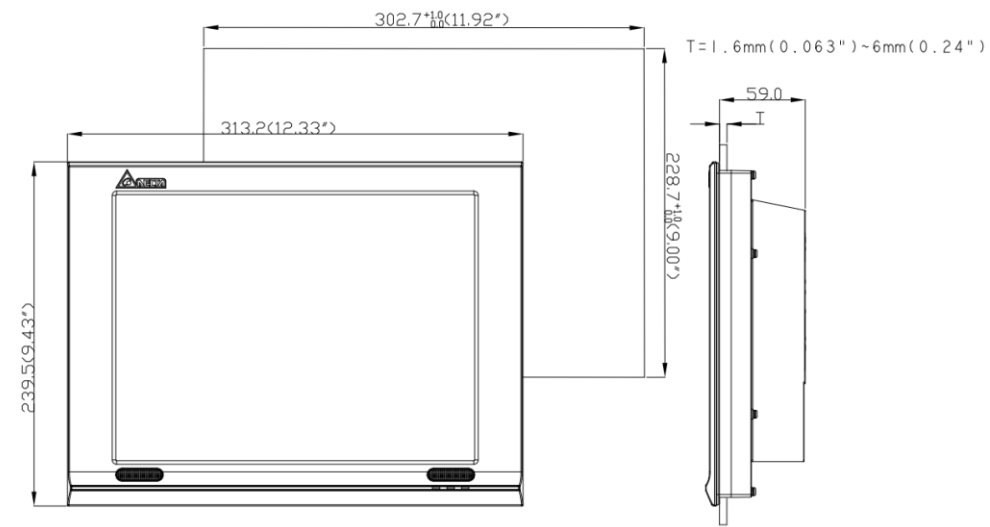

DOP-W157B

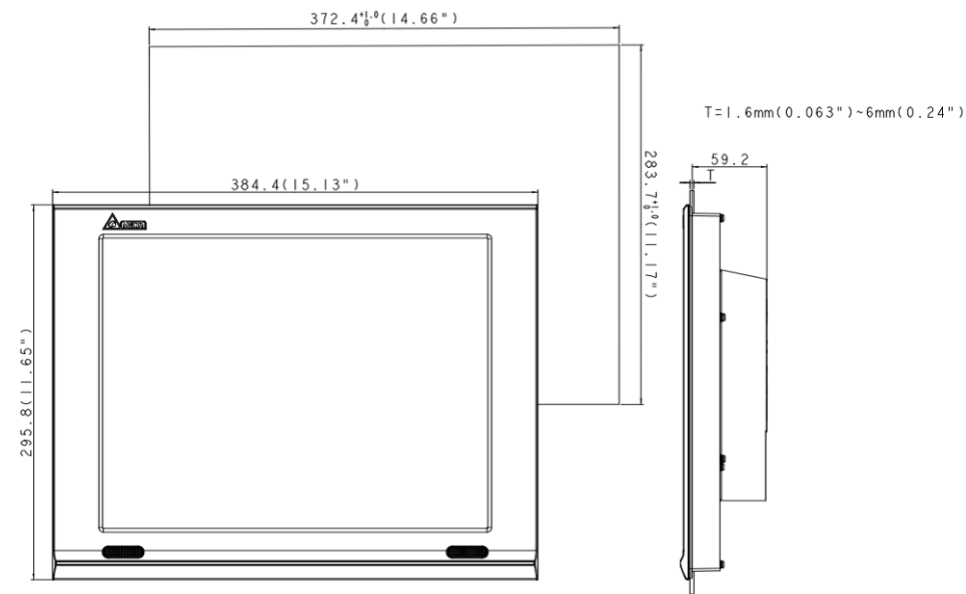

(6) 硬體規格

型號	DOP-W105B	DOP-W127B	DOP-W157B
面板種類	10.4" TFT LCD	12.1" TFT LCD	15" TFT LCD
解析度	800 x 600	1024 x 768	
背光燈	LED Back Light		
背光壽命	>10,000 Hrs	>30,000 Hrs	>80,000 Hrs
亮度	300 cd/m ² (Typ.)	500 cd/m ² (Typ.)	450 cd/m ² (Typ.)
顯示範圍	211.20 x 158.40mm	245.76*184.32mm	304.1*228.1mm
作業系統	Windows® CE 6.0		
中央處理器	ARM Cortex-A8 (1GHz)		
記憶體 ROM	SLC NAND Flash ROM 256 MB		
內部記憶體	256 Mbytes		
斷電保持容量	800000 筆(警報+歷史資料)		
觸控操作器	四線電阻式 > 10,000,000 operated		
蜂鳴器	Multi-Tone Frequency (2K ~ 4K Hz) / 80dB		
音效輸出	I2S Decode, Stereo Headphone jack only	I2S Decode, Stereo Headphone jack + Built in 1.5W Speaker	
USB	1 USB Host Ver 2.0	3 USB Host Ver 2.0	

型號	DOP-W105B	DOP-W127B	DOP-W157B
SD	SDHC X 1		
串列通訊埠	COM1	N/A	
	COM2	RS-232 / RS-422 / RS-485 (內建隔離電路 ^(Note 1))	
	COM3	RS-232 / RS-422 / RS-485 (內建隔離電路 ^(Note 1))	
Ethernet	2 Ports IEEE 802.3(10BASE-T) IEEE 802.3u(100BASE-TX) IEEE 802.3x (Full Duplex and flow control)		
萬年曆	內建		
冷卻方式	自然冷卻		
安規認證	CE / UL ^(Note 3)		
面板防水等級	IP65 / NEMA4 ^(Note 3)		
工作電壓 ^(Note 2)	DC +24V (-15% ~ +15%) (請使用隔離式電源供應器)		
絕緣耐力	DC24V 端子與 FG 端子間：AC500V, 1 分鐘		
消耗功率 ^(Note 2)	13.5W (Max)	18.5W (Max)	21.6W (Max)
記憶體備份電池	金電容, 永久不需更換電池		
備份電池壽命	本機規格定義之工作環境下, 可保持 RTC 工作至少七天		
操作環境溫度	0°C ~ 50°C		
儲存環境溫度	-20°C ~ +60°C, 10% ~ 90% RH		
操作環境溼度	10% ~ 90% RH [0 ~ 40°C] · 10% ~ 55% RH [41 ~ 50°C] · 污染等級 2		
雜訊免疫力	DOP-W105B / DOP-W-127B / DOP-W157B		
	ESD (IEC 61131-2, IEC 61000-4-2)	±6KV Contact Discharge ±10KV Air Discharge	
	EFT (IEC 61131-2, IEC 61000-4-4)	Power Line:±1KV (Class A) Communication I/O: ±500V (Class A)	
	Surge (IEC 61132-2, IEC 61000-4-5)	Power line ±1KV DM Series Port ±500V CM Ethernet ±500KV CM	
	RS (IEC 61131-2, IEC 61000-4-3)	80MHz ~ 1GHz, 10V/m. 1.4GHz ~ 2.0GHz, 10V/m	
	CS (EN 61000-4-6, IEC61131-2 9.10)	150kHz ~ 80MHz, 3V/m	
耐震動	IEC61131-2 規定連續震動 5Hz~8.3Hz 3.5mm, 8.3Hz~150Hz 1G		
耐衝擊	IEC60068-2-27 規定耐衝擊 11ms, 15G Peak, X, Y, Z 方向各 6 次		
尺寸 (W)x(H)x(D) mm	299*224*46.8	313*239.5*67.5	384.4*295.8*67.8
開孔尺寸 (W) x (H) mm	285.2*210.2	302.7*228.7	372.4*283.7
重量	約 1750g	約 2830g	約 3880g

NOTE

- 1) 隔離電路耐受規格：可承受 1 分鐘 1500V 高壓突波。
- 2) 消耗功率為無外接週邊設備時，人機本體所消耗的功率。建議選用的電源供應器容量為標示消耗功率之 1.5~2 倍，以確保人機工作正常。
- 3) 部份機種認證申請中，詳細認證機種請洽詢各區域代理商。
- 4) 本人機介面安裝手冊內所記載之規格若有變更，本公司恕不另行通知。當內容規格有所修正時，請洽詢代理商或至台達網站 <http://www.delta.com.tw/ia>。



DOP-W



高彩·宽屏幕·友善人机接口

DOP-W105B / DOP-W127B / DOP-W157B 安装说明

(1) 一般注意事项

感谢您使用本产品。本人机接口安装说明书提供 DOP-W 系列人机接口的相关信息。在使用之前，请您仔细阅读本说明书以确保使用上的正确。此外，请妥善将其放置在明显的地点以便随时查阅。下列事项在您尚未读完本说明书前，请务必遵守：

- 安装的环境必须没有水气、腐蚀性气体及可燃性气体。
- 接线时，请依接线图说明施工。
- 接地工程必须确实实施，接地时须遵照国家现行相关电工法规之规定施行（请参考 NFPA 70: National Electrical Code, 2005 Ed.）。
- 在通电时，请勿拆解人机接口或更改配线。
- 在通电运作时，请勿接触电源处，以免触电。

如果您在使用上仍有问题，请咨询经销商或者本公司客服中心。由于产品精益求精，当内容规格有所修正时，请咨询代理商或至台达网站 (<http://www.delta.com.tw/ia>) 下载最新版本。

(2) 安全注意事项

安装、配线、操作、维护及检查时，应随时注意以下安全注意事项。

安装注意



- 依照手册指定的方式安装人机接口，否则可能导致设备损坏。
- 禁止将本产品暴露在有水气、腐蚀性气体、可燃性气体等物质的场所下使用，否则可能会造成触电、火灾或爆炸。
- 请勿将人机接口安装在超过规格范围的温度环境中，否则可能造成人机接口无法正常运作或损坏。
- 本产品为 KCC Class A (商用设备) 产品且通过试验认证，其设计的目的是在商业或是工业环境使用，而非家庭环境中使用。若在此情况下不小心购买或售出人机接口产品，请将其更换为有符合 KCC Class B (家用设备) 认证之产品。
- 请勿将人机接口用于可能会造成人员伤亡、设备损坏或系统停机等警报机台。

配线注意



- 请将接地端子连接到 class-3 (100Ω 以下) 接地，接地不良可能会造成通讯异常、触电或火灾。

操作注意



- 人机接口需配合编辑软件规划画面，未经规划或确认之人机接口可能会导致不正常运转结果。为避免操作人身伤害或设备损坏，规划人机画面时，要确保人机接口及其连接控制器或设备之间的通讯故障不会造成设备功能无法正常运作。
- 为避免意外遗失程序，请务必备份规划好的人机接口画面程序。



- 不得在开启电源情况下改变配线，否则可能造成触电或人员受伤。
- 请勿以尖锐物品碰触面板，否则可能导致面板凹陷，进而无法使人机界面正常运作。

保养及检查



- 禁止接触人机接口内部，否则可能会造成触电。
- 电源启动时，禁止拆下人机接口面板，否则可能会造成触电。
- 电源关闭 10 分钟内，不得接触接线端子，残余电压可能造成触电。
- 更换备用电池时，应切断电源再进行，并在更换后重新检查系统设定值。
- 人机接口在操作时，排气孔不可封住，否则人机容易因为散热不良而造成故障。

配线方法



- 请勿使用超过人机接口规格范围的电压，否则可能会引起触电或火灾。
- 配线时请将快速接头从人机接口的本体上拆下来。
- 快速接头的一个电线插入口，请仅插入一根电线。
- 对于错误强行拔出电线的动作，请重新检查连接电线再启动。

通讯电路的配线



- 请依标准规格采用通讯配线线材。
- 通讯线材长度需在符合规定内。
- 采用正确的接地回路，以避免通讯不良。
- 为防止较大的噪声干扰引起人机接口无法正常运作，请用单独的配线槽将人机接口的通讯电缆和所有电源线及电机动力线分开。

(3) 通讯脚位定义

DOP-W105B / DOP-W127B / DOP-W157B COM2 定义

COM Port 示意图	脚位	MODE1	MODE2	MODE3
		RS-232	RS-422	RS-485
	1		TXD+	D+
	2	RXD		
	3	TXD		
	4		RXD+	
	5	SGND	SGND	SGND
	6		TXD-	D-
	7	RTS		
	8	CTS		
	9		RXD-	

注 1：空白 = 不需连接

DOP-W105B / DOP-W127B / DOP-W157B COM3 定义

COM Port 示意图	脚位	MODE1	MODE2	MODE3
		RS-232	RS-422	RS-485
	1		TXD+	D+
	2	RXD		
	3	TXD		
	4		RXD+	
	5	SGND	SGND	SGND
	6		TXD-	D-
	7	RTS		
	8	CTS		
	9		RXD-	

注 1：空白 = 不需连接

(4) 各部位说明

DOP-W105B (正面)

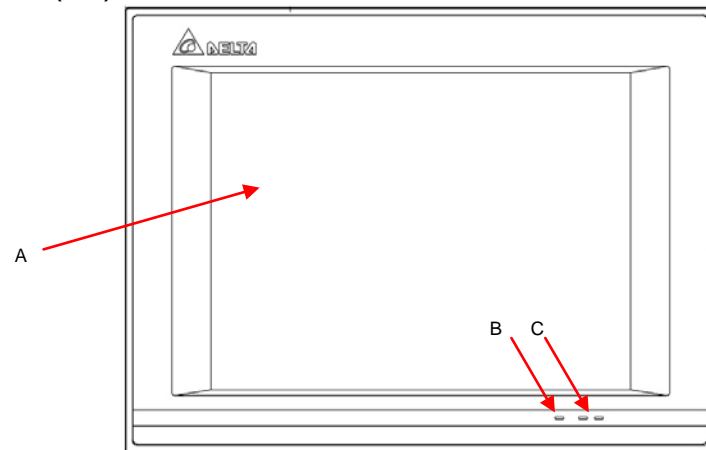

A	操作 / 显示区域	B	电源指示灯
C	动作指示灯 / 警报指示灯		

DOP-W105B (背面)

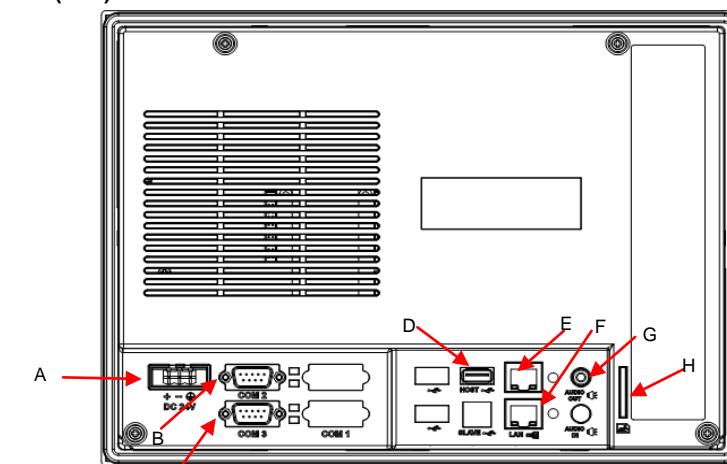

A	电源输入端子	B	COM2
C	COM3	D	USB Host
E	Ethernet LAN1	F	Ethernet LAN2
G	Audio	H	SD

DOP-W127B / DOP-W157B (正面)

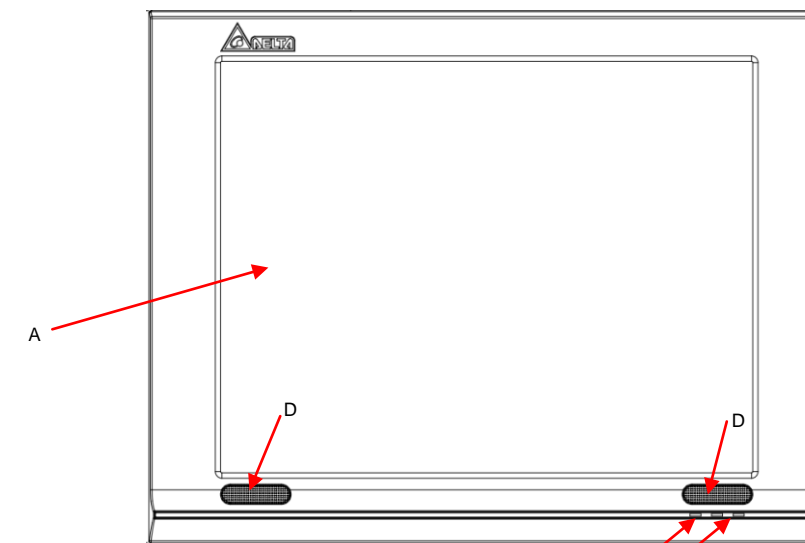

A	操作 / 显示区域	B	电源指示灯
C	动作指示灯 / 警报指示灯	D	1.5 瓦喇叭

DOP-W127B (背面)

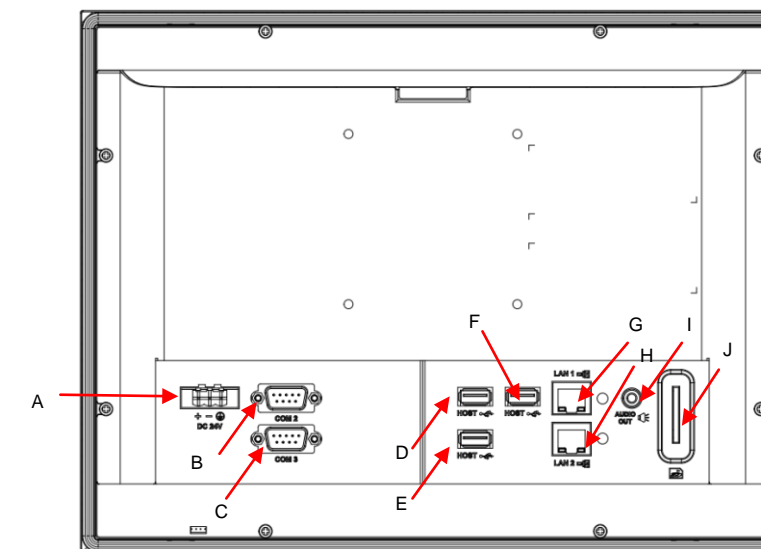

A	电源输入端子	B	COM2
C	COM3	D	USB Host
E	USB Host	F	USB Host
G	Ethernet LAN1	H	Ethernet LAN2
I	Audio	J	SD

DOP-W157B (背面)

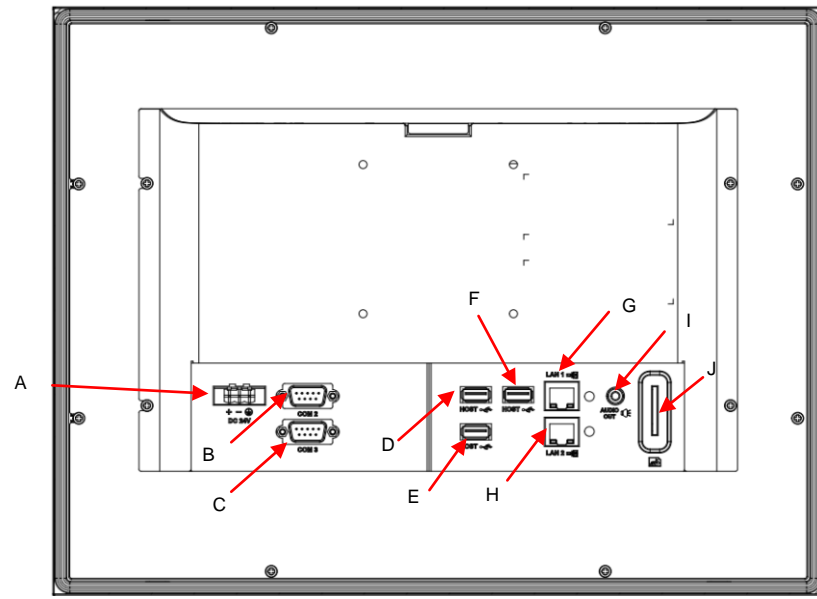

A	电源输入端子	B	COM2
C	COM3	D	USB Host
E	USB Host	F	USB Host
G	Ethernet LAN1	H	Ethernet LAN2
I	Audio	J	SD

(5) 开孔尺寸

DOP-W105B

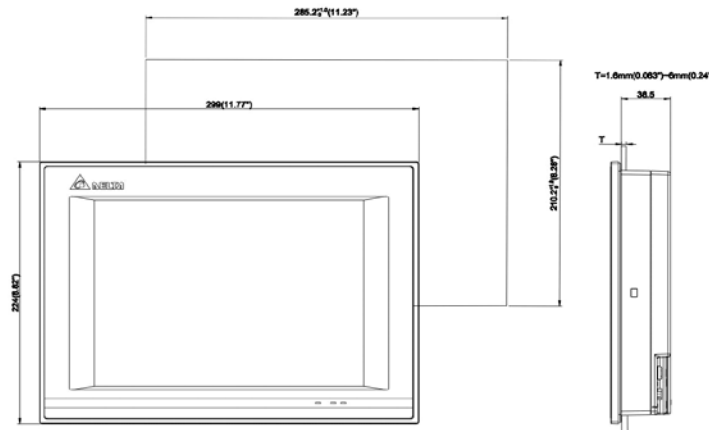

DOP-W127B

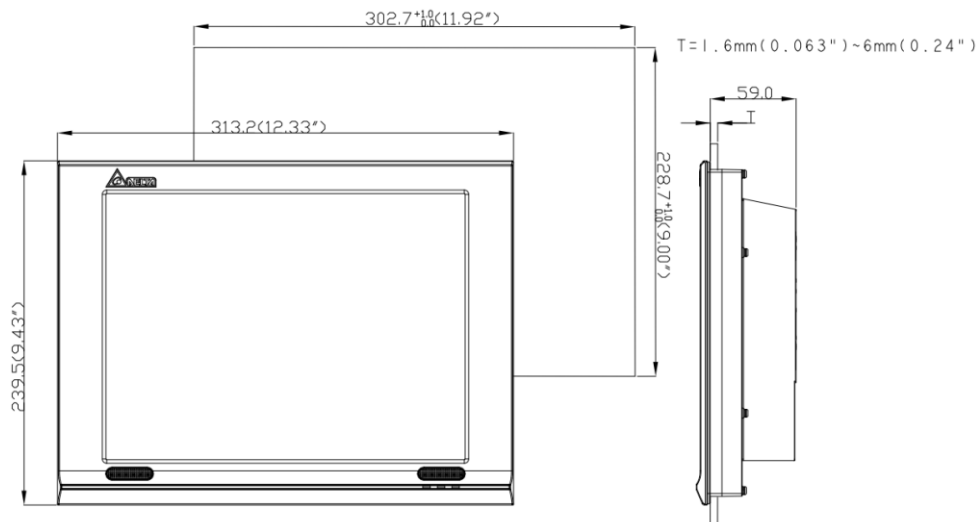

DOP-W157B

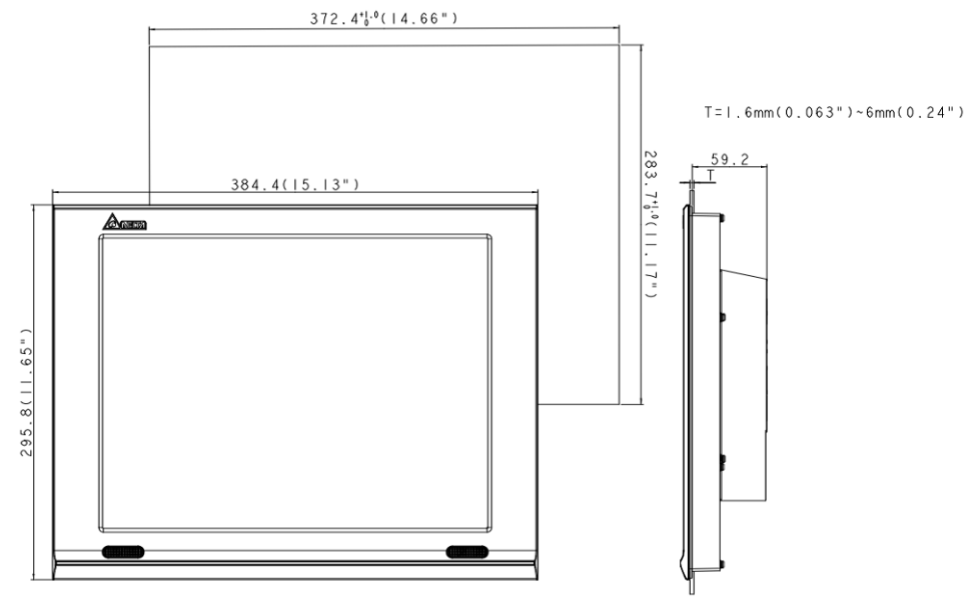

(6) 硬件规格

型号		DOP-W105B	DOP-W127B	DOP-W157B
显示器	面板种类	10.4" TFT LCD	12.1" TFT LCD	15" TFT LCD
	分辨率	800 x 600	1024 x 768	
	背光灯	LED Back Light		
	背光寿命	>10,000 Hrs	>30,000 Hrs	>80,000 Hrs
	亮度	300 cd/m ² (Typ.)	500 cd/m ² (Typ.)	450 cd/m ² (Typ.)
	显示范围	211.20 x 158.40mm	245.76*184.32mm	304.1*228.1mm
操作系统		Windows® CE 6.0		
中央处理器		ARM Cortex-A8 (1GHz)		
内存 ROM		SLC NAND Flash ROM 256 MB		
内部存储器		256 Mbytes		
断电保持容量		800000 笔(警报+历史资料)		
触控操作器		四线电阻式 > 10,000,000 operated		
蜂鸣器		Multi-Tone Frequency (2K ~ 4K Hz) / 80dB		
音效输出		I2S Decode, Stereo Headphone jack only	I2S Decode, Stereo Headphone jack + Built in 1.5W Speaker	
USB		3 USB Host Ver 2.0		
SD		SDHC X 1		
串行通讯端口	COM1	N/A		
	COM2	RS-232 / RS-422 / RS-485 (内建隔离电路 ^(Note 1))		
	COM3	RS-232 / RS-422 / RS-485 (内建隔离电路 ^(Note 1))		
Ethernet		2 Ports IEEE 802.3(10BASE-T) IEEE 802.3u(100BASE-TX) IEEE 802.3x (Full Duplex and flow control)		
万年历		内建		
冷却方式		自然冷却		
安规认证		CE / UL ^(Note 3)		
面板防水等级		IP65 ^(Note 3)		
工作电压 ^(Note 2)		DC +24V (-15% ~ +15%) (请使用隔离式电源供应器)		
绝缘耐力		DC24V 端子与 FG 端子间 : AC500V, 1 分钟		
消耗功率 ^(Note 2)		13.5W (Max)	18.5W (Max)	21.6W (Max)
内存备份电池		金电容, 永久不需更换电池		
备份电池寿命		本机规格定义之工作环境下, 可保持 RTC 工作至少七天		
操作环境温度		0°C ~ 50°C		
储存环境温度		-20°C ~ +60°C, 10% ~ 90% RH		
操作环境湿度		10% ~ 90% RH [0 ~ 40 oC] · 10% ~ 55% RH [41 ~ 50 oC] · 污染等级 2		
DOP-W105B / DOPW127B / DOP-W157B				
ESD		±6KV Contact Discharge		
(IEC 61131-2, IEC 61000-4-2)		±10KV Air Discharge		

噪声免疫力	EFT	Power Line:±1KV (Class A)	
	(IEC 61131-2, IEC 61000-4-4)	Communication I/O: ±500V (Class A)	
	Surge	Power line ±1KV DM	
	(IEC 61132-2, IEC 61000-4-5)	Series Port ±500V CM	
		Ethernet ±500KV CM	
RS	80MHz ~ 1GHz, 10V/m. 1.4GHz ~ 2.0GHz, 10V/m		
(IEC 61131-2, IEC 61000-4-3)			
CS	150kHz ~ 80MHz, 3V/m		
(EN 61000-4-6, IEC61131-2 9.10)			
耐震动	IEC61131-2 规定连续震动 5Hz~8.3Hz 3.5mm, 8.3Hz~150Hz 1G		
耐冲击	IEC60068-2-27 规定耐冲击 11ms, 15G Peak, X, Y, Z 方向各 6 次		
尺寸 (W) x (H) x (D) mm	299*224*46.8	313*239.5*67.5	384.4*295.8*67.8
开孔尺寸 (W) x (H) mm	285.2*210.2	302.7*228.7	372.4*283.7
重量	约 1750g	约 2830g	约 3880g

NOTE

- 1) 隔离电路耐受规格: 可承受 1 分钟 1500V 高压突波。
- 2) 消耗功率为无外接外围设备时, 人机本体所消耗的功率。建议选用的电源供应器容量为标示消耗功率之 1.5~2 倍, 以确保人机工作正常。
- 3) 部份机种认证申请中, 详细认证机种请咨询各区域代理商。
- 4) 本人机接口安装手册内所记载之规格若有变更, 本公司恕不另行通知。当内容规格有所修正时, 请咨询代理商或至台达网站 <http://www.delta.com.tw/ia>。