



Automation for a Changing World

Delta Advanced Ethernet Human Machine Interface DOP-100 Series



www.deltaww.com

 **DELTA**
Smarter. Greener. Together.

Connect Your Work, Step into the Cloud

The new advanced Delta Ethernet Human Machine Interface DOP-100 Series adopts the panel with high brightness, high contrast and high color. With the coming era of Industry 4.0, it is more popular. For customers that are beginning to step into the cloud, the complete DOP-100 Series offers various communication functions, including FTP, e-mail, VCN remote monitoring, and NTP (Network Time Protocol). It also supports 16 languages* input to achieve localized operation for global customers.

With advanced communication capabilities and enhanced functions, the DOP-100 Series is designed to bring "Automation for a Changing World" to our customers.

* Supports 16 languages input: English, Traditional Chinese, Simplified Chinese, French, German, Russian, Japanese, Korean, Spanish, Italian, Portuguese, Dutch, Swedish, Danish, Norwegian, and Finnish.



the latest Cortex-A8 high-speed processor and display
Industrial 4.0, cloud applications are becoming more
DOP Series features built-in Ethernet and other network
Time Protocols). The DOP-100 Series supports

s elevates machine efficiency with more value-added

ean, Spanish, Portuguese, Hindi, Turkish, Arabic, Persian, Italian and Polish



Table of Contents

Design 3

- Compact Design
- Bright and Colorful Display
- Abundant Elements
- Smooth Animation

Robust Hardware 4

- Power Isolation
- Fully Isolated Communication Interface
- PCB Coating

Strengthened Functions 5

- Advanced Alarm
- Historical Data
- Historical Data Review
- Zoom In / Out Display
- Recipes
- PDF for Data Review
- Multi-language Input
- Account and Authorization Management
- Operation Log

Cloud Integration 10

- FTP Server
- VNC Server
- Web Monitor

Product Information 11

- Ordering Information
- Dimensions
- Specifications

Design

Compact Design

- ▶ More compact with narrow frame and lighter case to save installation space



Bright and Colorful Display

- ▶ New LCD panel with high brightness and high contrast display for colorful and vivid operation



Abundant Elements

- ▶ Abundant built-in element graphics for vivid interface display for a variety of industrial applications

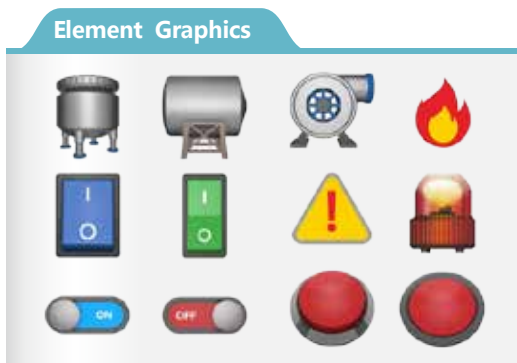

Smooth Animation

- ▶ New smooth animation technology for realistic dashboard display

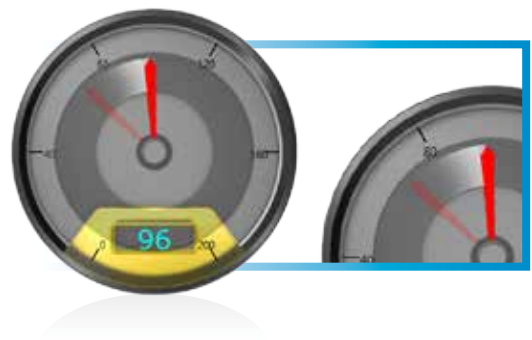

Robust Hardware



Power Isolation

- ▶ Complete series with built-in power isolation circuits provides the most complete protection against accidental external spikes

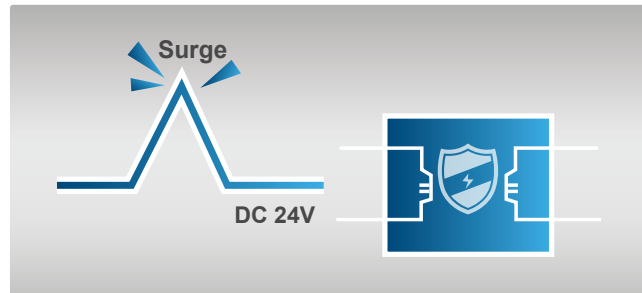

Fully Isolated Communication Interface

- ▶ Complete series has built-in COM and Ethernet isolation circuits to protect against noise that can occur from the grounding of various devices such as PLCs, servo drives, inverters and others
- ▶ Ensures stable operation and communication quality



PCB Coating

- ▶ Complete series has PCB coating for enhanced durability and to protect against humidity and dust for applications in a range of environments

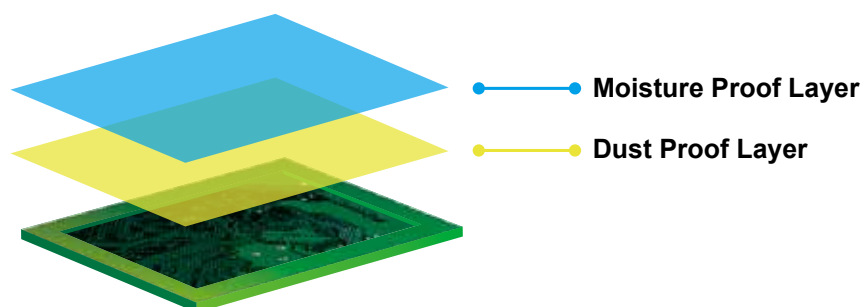

Strengthened Functions

Advanced Alarm

Strengthened alarm functions allow users to easily manage machine operations and quickly eliminate problems

- Alarm messages contain current register data for issue analysis

Detail			Properties												
No.	Message Content	Category													
1*	Temp. too High , PV is %d1	1	 <table border="1"> <thead> <tr> <th colspan="2">Message</th> </tr> </thead> <tbody> <tr> <td>Temp. too Low , PV is 12</td> <td></td> </tr> <tr> <td>Temp. too High , PV is 91</td> <td></td> </tr> <tr> <td>Temp. too Low , PV is 15</td> <td></td> </tr> <tr> <td>Temp. too Low , PV is 23</td> <td></td> </tr> </tbody> </table>			Message		Temp. too Low , PV is 12		Temp. too High , PV is 91		Temp. too Low , PV is 15		Temp. too Low , PV is 23	
Message															
Temp. too Low , PV is 12															
Temp. too High , PV is 91															
Temp. too Low , PV is 15															
Temp. too Low , PV is 23															
2*	Temp. too Low , PV is %d1	1													
3*	PV is %d1 , ALM Mail	2													
4		0													
5		0													

Alarm Sorting

Alarm sorting via "Sorting" function based on alarm attributes for quick information inquiries

Supports Compound Address Monitoring

Able to monitor Word and Bit documents at the same time

Detail		Properties				
No.	Message Content	Category	Type	Address	Trigger Condition	Monitor Address
1*	Temp. too High , PV is %d1	1	Word	\$15	\$15 > 70	\$15
2*	Temp. too Low , PV is %d1	1	Word	\$15	\$15 < 30	\$15
3*	PV is %d1 , ALM Mail	2	Bit	\$198.4	On	\$15
4		0	Bit	None	On	None

Versatile Alarm Triggering Conditions

Triggering conditions can be setup via built-in function, no external editing programs required

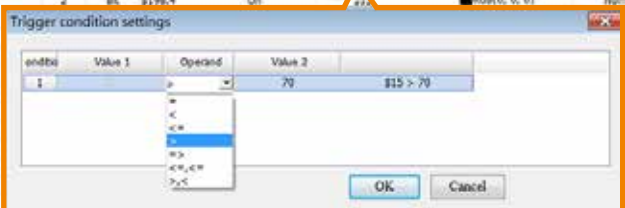

The screenshot shows a 'Trigger condition settings' dialog box with a table for defining conditions. The table has columns for 'endBit', 'Value 1', 'Operand', 'Value 2', and 'Trigger Condition'. A dropdown menu is open, showing various comparison operators like '>', '<', '<=', '>=', '<=<=', and '>=>'. The background shows a table with columns: No., Message Content, Category, Type, Address, Trigger Con, Monitor Address, Text Color, and Alarm S.

Alarm Notification

Automatically sends out alarm notification emails to logged-in recipients when alarms occur and supports the Secure Sockets Layer (SSL) protocol to ensure safe data transmission

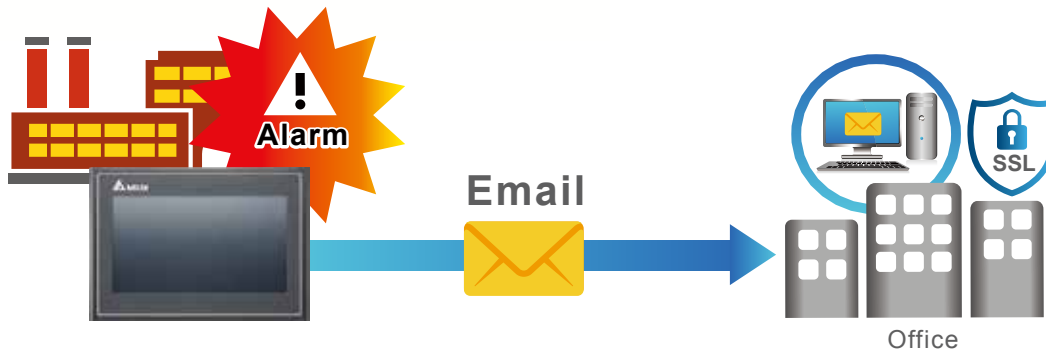

- Indicates the alarm trigger and recovery time, and provides alarm acknowledge time / date (Ack) to confirm and monitor troubleshooting progress

Message	Trigger	Ack	Recovery
Temp. too Low • PV is 12	15:07:12 02/03/2017		15:07:15 02/03/2017
Temp. too High • PV is 91	15:07:15 02/03/2017	15:07:56 02/03/2017	15:07:22 02/03/2017
Temp. too Low • PV is 15	15:07:22 02/03/2017		15:07:25 02/03/2017
Temp. too Low • PV is 23	15:07:28 02/03/2017	15:07:58 02/03/2017	15:07:34 02/03/2017

Alarm Filtering

Advanced address control filtering allows users to find specified alarm messages according to user needs

Alarm Ordering

Able to display alarms in the order of Trigger Time / Confirm Time / Restore Time

Action	
Address control filtering allows users to find specified alarms	
No.	Action
0	Preset state, shows all triggered alarms
1	Hide alarms with "Restore Time" and "Confirm Time"
2	Hide alarms with "Restore Time"
3	Hide alarms with "Restore Time" or "Confirm Time"
4	Hide alarms with "Confirm Time"

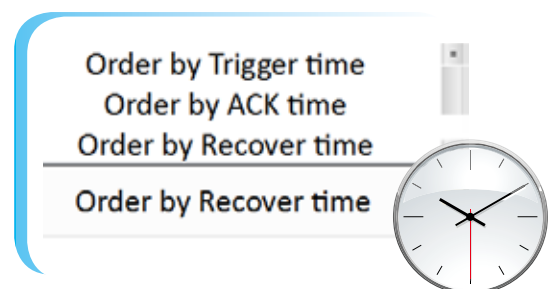

Historical Data

- ▶ Able to generate historical reports with user-defined file names and timestamps through Bit Control

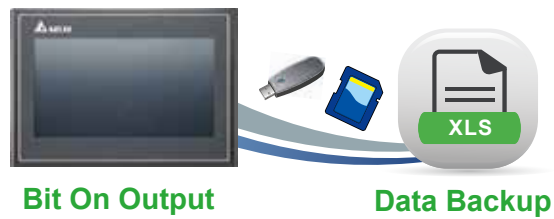

Save As Mul

File Date
None %m %d

File Time
%H %M None

File Name
DOP

Saving trigger
\$175.0

Historical Data Review

- ▶ Allows historical data review on backup in USB disk or SD cards



Zoom In / Out Display

- ▶ Zoom in / out function for convenient data viewing

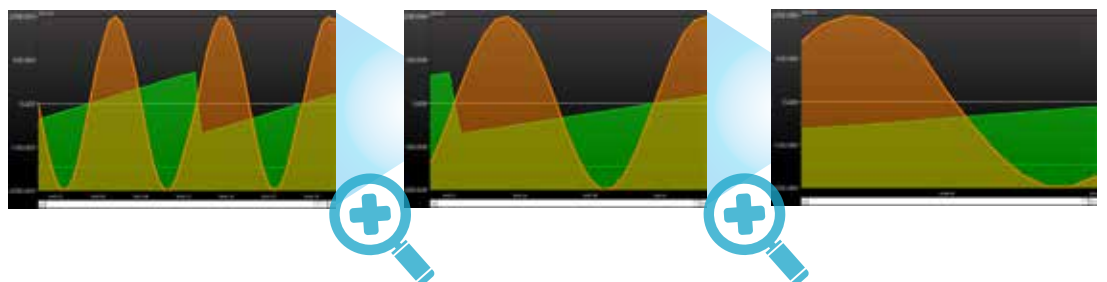

Recipes

- ▶ Supports 2D and 3D recipe grouping, more flexible in building recipe database
- ▶ Various recipe formats, including text format (Unicode) which can also be used as formula notes

	D100	D101	D102	D103	D104	D105	D106	
								50.7
Cake Recipe 1	Strawberry	300	0	0	221.56	533.1	150.7	63.9
Cake Recipe 2	Chocolate	0	300	0	387.98	490.8	163.9	79.8
Cake Recipe 3	Vanilla	0	0	300	120.14	505.3	279.8	
	Strawberry	Chocolate	Vanilla		Sugar	Flour	Milk	
	Char	Unsigned DEC			Floating			

Recipe Group 2 (points to D106 column)

Recipe Group 1 (points to D104-D106 columns)

- ▶ Recipes can be saved in CSV files for convenient editing on PCs
- ▶ Allows recipe update or backup through USB disks, SD cards or FTP

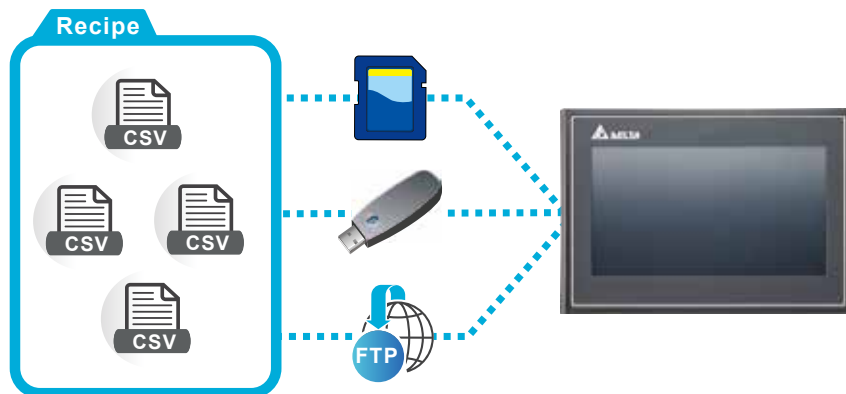

PDF for Data Review

- ▶ Saves manuals or instruction PDF files in USB disks or SD cards for reference anytime



Strengthened Functions

Multi-language Input

- ▶ Localized operation with 16 languages input for recipe context / note and account / password



Supports English, Traditional Chinese, Simplified Chinese, French, German, Russian, Japanese, Korean, Spanish, Portuguese, Hindi, Turkish, Arabic, Persian, Italian and Polish input

Account and Authorization Management

- ▶ Supports 8 levels of authority and allows 8 accounts (account name/password) for each level
- ▶ Different function and operation access for each authority level to enhance operation safety

Number	Account	Password
1	MANAGER	7777
2	GERENTE	7777
3	經理	7777
4	MÜDÜR	7777
5	課長	7777



Login

Security Login

Account

Password

Operation Log

- ▶ Operation log for different user accounts to trace/analyze possible causes of malfunctions
- ▶ Provides a comprehensive information for managers to analyze the operating habits of different users and improve efficiency

Time	Date	User	Level	Screen	Action	Address	Pre Value	Change Value	Description
19:22:18	2016.12.02	MANAGER7	7	Screen_9	Goto Scrn		6	1	換置前_006
19:22:20	2016.12.02	MANAGER7	7	Screen_1	Goto Scrn		1	10	換置前_001
19:22:24	2016.12.02	MANAGER7	7	Screen_10	Set Val	\$51.1	1	0	交野型_003
19:22:27	2016.12.02	MANAGER7	7	Screen_10	Goto Scrn		10	1	換置前_006
19:22:30	2016.12.02	MANAGER7	7	Screen_1	Goto Scrn		1	7	換置前_001
19:22:57	2016.12.02	MANAGER7	7	Screen_7	Set Val	\$20	-730	-698	數值輸入_0
19:23:02	2016.12.02	MANAGER7	7	Screen_7	Goto Scrn		7	1	換置前_006
19:23:05	2016.12.02	MANAGER7	7	Screen_1	Goto Scrn		1	6	換置前_001
19:23:47	2016.12.02	MANAGER7	7	Screen_6	Level Switch		7	4	密碼輸入_0
19:23:52	2016.12.02	OPERATOR4	4	Screen_6	Set Scrn		6	1	換置前_006
19:23:55	2016.12.02	OPERATOR4	4	Screen_1	Goto Scrn		1	3	換置前_001
19:24:03	2016.12.02	OPERATOR4	4	Screen_3	Set Val	ENRCP10	12ED	65AE	數值輸入_0
19:24:09	2016.12.02	OPERATOR4	4	Screen_3	Set Val	ENRCP11	456.32	125.93	數值輸入_0
19:24:14	2016.12.02	OPERATOR4	4	Screen_3	Set Val	ENRCP17	400	452	數值輸入_0
19:24:15	2016.12.02	OPERATOR4	4	Screen_3	Goto Scrn		3	1	換置前_006
19:24:17	2016.12.02	OPERATOR4	4	Screen_1	Goto Scrn		1	6	換置前_001

Cloud Integration



FTP Server

- ▶ Built-in FTP server to update recipes or PDF files, and backup historical data, operation log and alarms

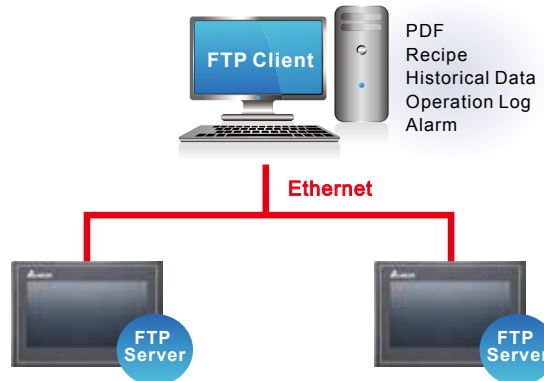

VNC Server

- ▶ Built-in VNC server allows remote monitoring and operating of the DOP-100 Series via VNC Client APP (Windows, iOS, Android)
- ▶ Lock function: block remote operation during on-site operation to avoid unsynchronized commands. VNC server allows remote monitoring but not remote operation when the lock function is on

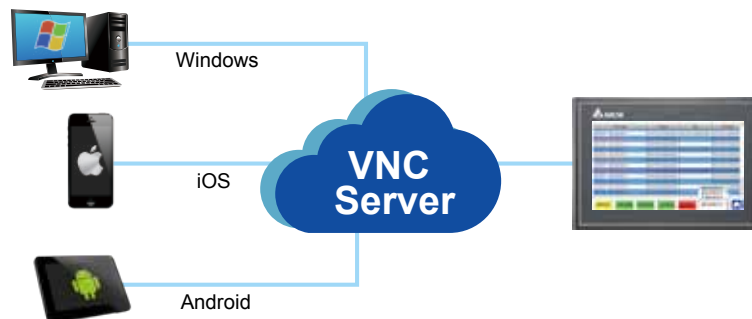

Web Monitoring

- ▶ Allows direct monitoring of register data via web page, and requires no additional software installation

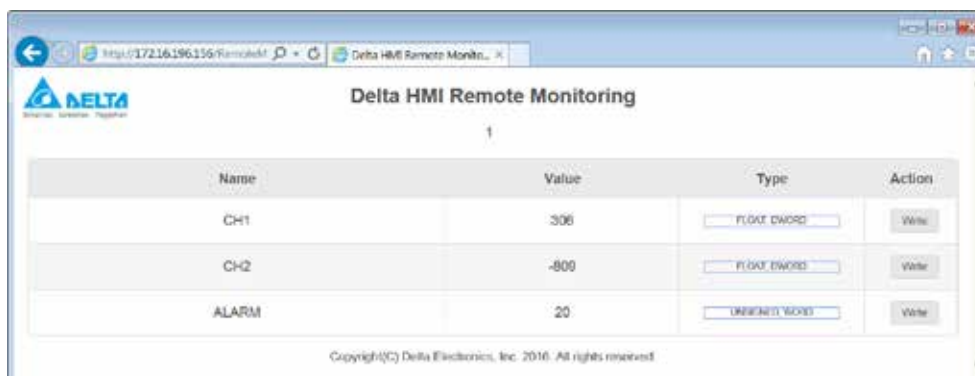

Ordering Information

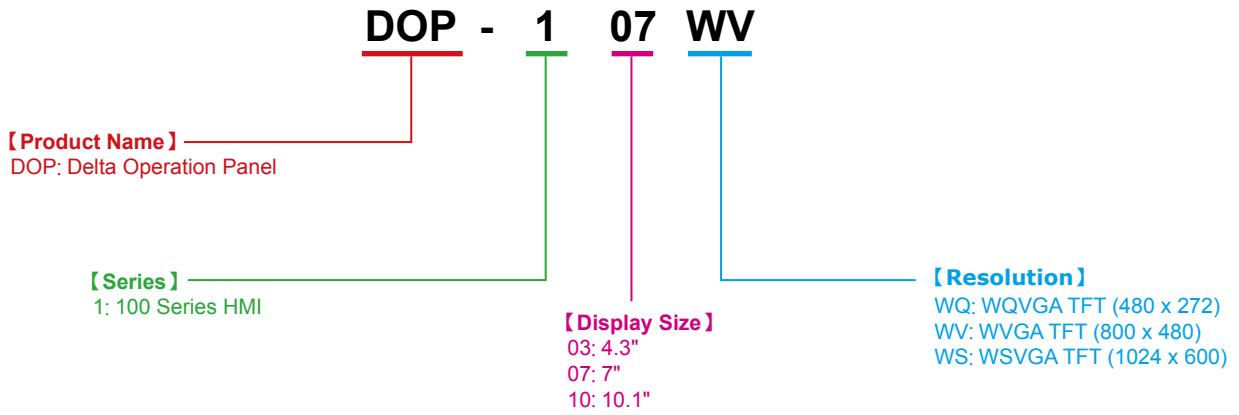

Dimensions Unit: mm (inches)

• DOP-103WQ

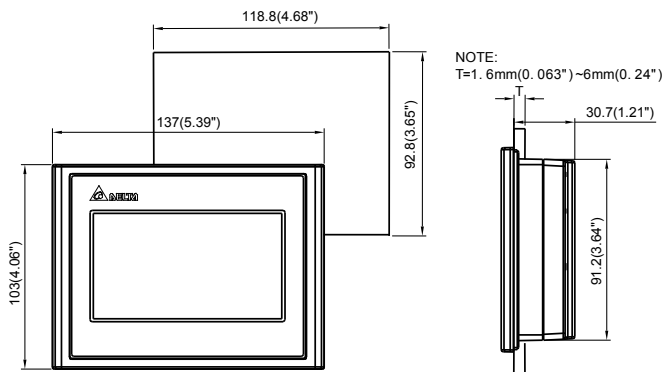

• DOP-107WV

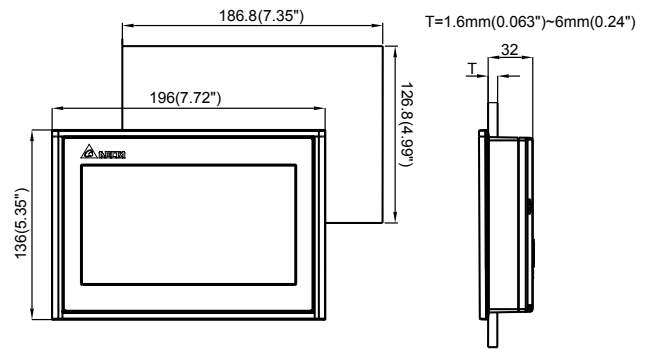

• DOP-110WS

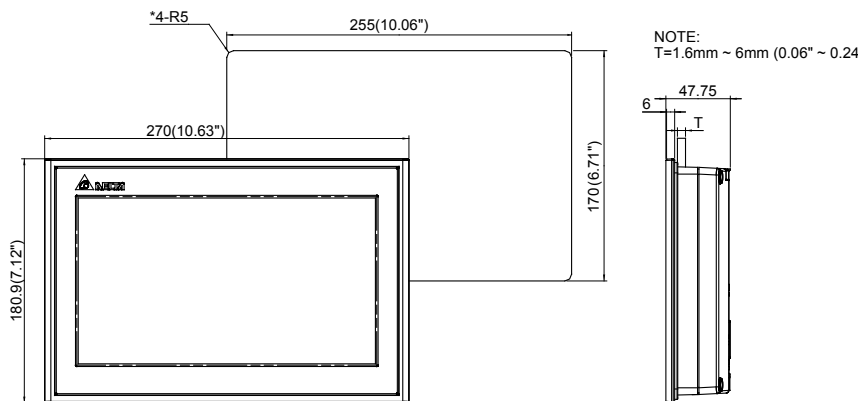

Specifications

Model		DOP-103WQ	DOP-107WV	DOP-110WS
LCD Module	Display	4.3" TFT LCD	7" TFT LCD	10.1" TFT LCD
	Color	65,536		
	Resolution (Pixels)	480 x 272	800 x 480	1024 x 600
	Back Light	LED Back Light		
	Back Light Brightness (cd/m ²)	400	450	450
	Back Light Life (Hour) ^(Note 1)	10,000	30,000	30,000
MCU		ARM Cortex-A8 (800MHz)		
Flash ROM (Bytes)		256 MB		
RAM (Bytes)		512 MB		
Touch Panel		Four-wire resistor, over 10,000,000 pressing times		
Buzzer		Multi-Tone Frequency (2K ~ 4K Hz) / 80dB		
Ethernet Interface		1 Port ^(Note 2) , 10/100 Mbps auto-sensing		
USB		1 USB Slave Ver 2.0 / 1 USB Host Ver 2.0		
SD		N/A	N/A	SD x 1
Serial COM Port	COM1	RS-232 (supports hardware flow control) / RS-485 ^(Note 2)	RS-232 (supports hardware flow control)	
	COM2	RS-422 / RS-485 ^(Note 2)	RS-232 (supports hardware flow control) / RS-485 ^(Note 2)	
	COM3	N/A	RS-422 / RS-485 ^(Note 2)	
RTC		Yes		
Cooling		Nature air circulation		
Certification		CE / UL		
Waterproof		IP65 / NEMA4 / UL Type 4X (indoor use only)		
Operation Voltage ^(Note 3)		DC +24V (-15% ~ +15%) ^(Note 2)		
Voltage Endurance		A599V for 1 minute (between charging DC24 terminal and FG terminals)		
Power Consumption ^(Note 5)		5.8 W (Max)	8.4W (Max)	11 W (Max)
Backup Battery		3V lithium battery CR2032 x 1		
Backup Battery Life		Depends on the temperature used and the conditions of usage, usually about 3 years or more at 25° C		
Operation Temperature		0°C ~ 50°C		
Storage Temperature		-20 °C ~ +60 °C		
Ambient Humidity		10% ~ 90% RH (0 ~ 40° C), 10% ~ 55% RH (41 ~ 50° C), Pollution Degree 2		
Vibration		IEC 61131-2 compliant 5Hz ~ 8.3Hz = Continuous: 3.5mm, 8.3Hz ~ 150Hz = Continuous: 1.0g		
Shock		IEC 60068-2-27 compliant 15g peak for 11ms duration, X, Y, Z, directions for 6 times		
Dimensions (W) x (H) x (D) mm		137 x 103 x 37.1	196 x 136 x 39	270 x 180.9 x 47.75
Dimensions (W) x (H) mm		118.8 x 92.8	186.8 x 126.8	255.5 x 170.5
Weight		280g	560g	1,100g

1) The half-life of a backlight is defined as the original luminance being reduced by 50% when the maximum driving current is supplied to the HMI

2) Built-in power isolation

3) It is recommended to adopt an isolated power supply.

4) Some models are in the process of application for UL and KCC certification. For more information, please consult our distributors.

5) The value of the power consumption indicates the electrical power consumed by the HMI with no peripheral devices connected.

6) The content of this catalogue may be revised without prior notice. Please consult our distributors or download the most updated version at <http://www.deltaww.com>

Global Operations

ASIA (Taiwan)



Taoyuan Technology Center (Green Building)



Taoyuan Plant 1



Taoyuan Plant (Diamond-rated Green Building)

ASIA (China)



Wujiang Plant 3



Delta Electronics



ASIA (Japan)



Tokyo Office

ASIA (India)



Rudrapur Plant
(Green Building)

EUROPE



Amsterdam, Netherlands

AMERICA



Research Triangle Park

▲ Factories 4 ■ Branch Offices 89 ● R&D Centers 5 ■ Distributors 635

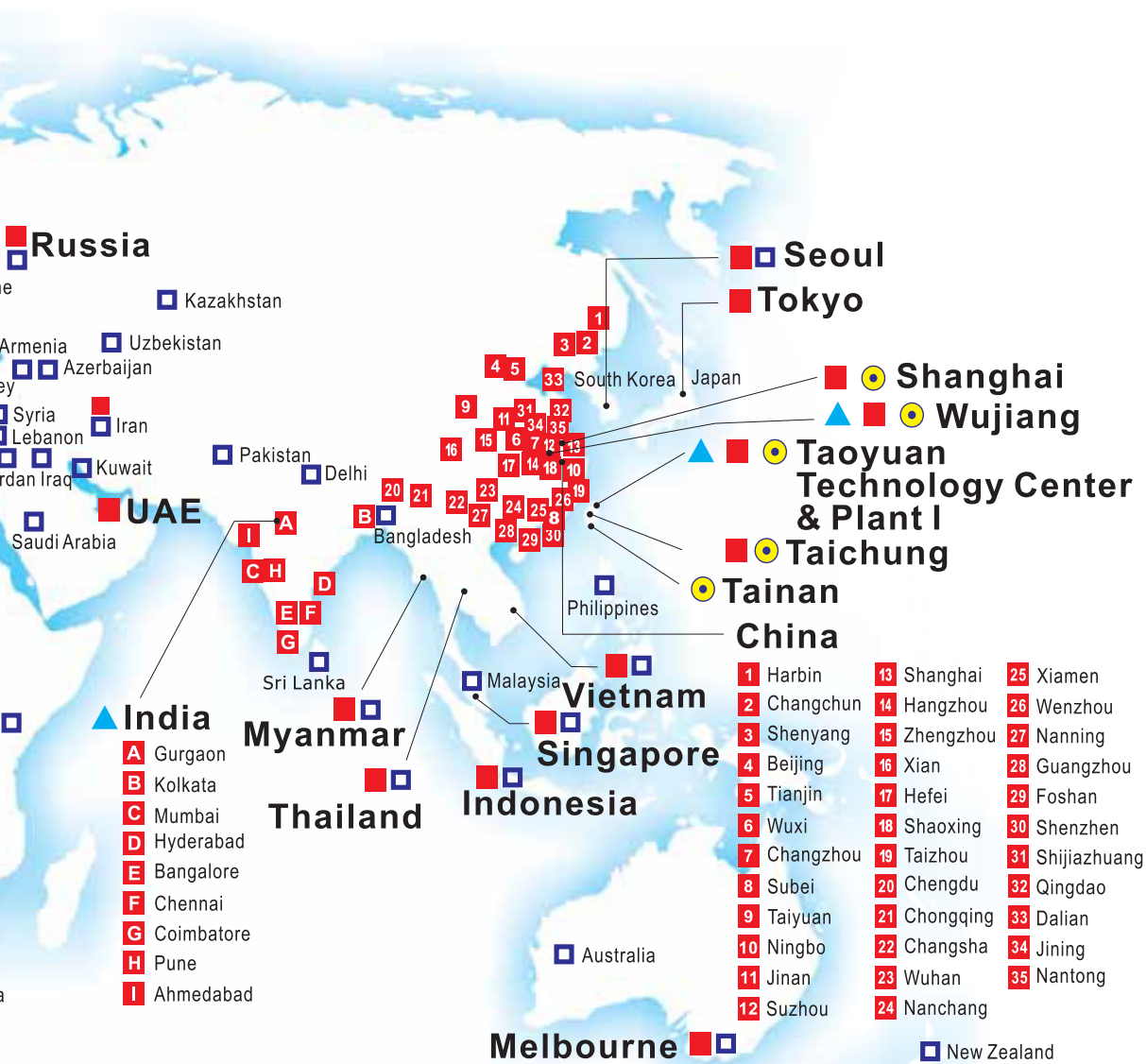



Smarter. Greener. Together.

Industrial Automation Headquarters

Delta Electronics, Inc.

Taoyuan Technology Center
No.18, Xinglong Rd., Taoyuan City,
Taoyuan County 33068, Taiwan
TEL: 886-3-362-6301 / FAX: 886-3-371-6301

Asia

Delta Electronics (Jiangsu) Ltd.

Wujiang Plant 3
1688 Jiangxing East Road,
Wujiang Economic Development Zone
Wujiang City, Jiang Su Province,
People's Republic of China (Post code: 215200)
TEL: 86-512-6340-3008 / FAX: 86-769-6340-7290

Delta Greentech (China) Co., Ltd.

238 Min-Xia Road, Pudong District,
ShangHai, P.R.C.
Post code : 201209
TEL: 86-21-58635678 / FAX: 86-21-58630003

Delta Electronics (Japan), Inc.

Tokyo Office
2-1-14 Minato-ku Shibadaimon,
Tokyo 105-0012, Japan
TEL: 81-3-5733-1111 / FAX: 81-3-5733-1211

Delta Electronics (Korea), Inc.

1511, Byucksan Digital Valley 6-cha, Gasan-dong,
Geumcheon-gu, Seoul, Korea, 153-704
TEL: 82-2-515-5303 / FAX: 82-2-515-5302

Delta Electronics Int'l (S) Pte Ltd

4 Kaki Bukit Ave 1, #05-05, Singapore 417939
TEL: 65-6747-5155 / FAX: 65-6744-9228

Delta Electronics (India) Pvt. Ltd.

Plot No 43 Sector 35, HSIIDC
Gurgaon, PIN 122001, Haryana, India
TEL : 91-124-4874900 / FAX : 91-124-4874945

Americas

Delta Products Corporation (USA)

Raleigh Office
P.O. Box 12173, 5101 Davis Drive,
Research Triangle Park, NC 27709, U.S.A.
TEL: 1-919-767-3800 / FAX: 1-919-767-8080

Delta Greentech (Brasil) S.A

Sao Paulo Office
Rua Itapeva, 26 - 3° andar Edificio Itapeva One-Bela Vista
01332-000-São Paulo-SP-Brazil
TEL: +55 11 3568-3855 / FAX: +55 11 3568-3865

Europe

Delta Electronics (Netherlands) B.V.

Eindhoven Office
De Witbegt 20, 5652 AG Eindhoven, The Netherlands
TEL: +31 (0)40-8003800 / FAX: +31 (0)40-8003898

*We reserve the right to change the information in this catalogue without prior notice.