



Industrial Automation Headquarters

Delta Electronics, Inc.
Taoyuan Technology Center
No.18, Xinglong Rd., Taoyuan City,
Taoyuan County 33068, Taiwan
TEL: 886-3-362-6301 / FAX: 886-3-371-6301

Asia

Delta Electronics (Jiangsu) Ltd.
Wujiang Plant 3
1688 Jiangxing East Road,
Wujiang Economic Development Zone
Wujiang City, Jiang Su Province,
People's Republic of China (Post code: 215200)
TEL: 86-512-6340-3008 / FAX: 86-769-6340-7290

Delta Greentech (China) Co., Ltd.
238 Min-Xia Road, Pudong District,
ShangHai, P.R.C.
Post code : 201209
TEL: 86-21-58635678 / FAX: 86-21-58630003

Delta Electronics (Japan), Inc.
Tokyo Office
2-1-14 Minato-ku Shibadaimon,
Tokyo 105-0012, Japan
TEL: 81-3-5733-1111 / FAX: 81-3-5733-1211

Delta Electronics (Korea), Inc.
1511, Byucksan Digital Valley 6-cha, Gasan-dong,
Geumcheon-gu, Seoul, Korea, 153-704
TEL: 82-2-515-5303 / FAX: 82-2-515-5302

Delta Electronics Int'l (S) Pte Ltd
4 Kaki Bukit Ave 1, #05-05, Singapore 417939
TEL: 65-6747-5155 / FAX: 65-6744-9228

Delta Electronics (India) Pvt. Ltd.
Plot No 43 Sector 35, HSIIDC
Gurgaon, PIN 122001, Haryana, India
TEL : 91-124-4874900 / FAX : 91-124-4874945

Americas

Delta Products Corporation (USA)
Raleigh Office
P.O. Box 12173, 5101 Davis Drive,
Research Triangle Park, NC 27709, U.S.A.
TEL: 1-919-767-3800 / FAX: 1-919-767-8080

Delta Greentech (Brasil) S.A
Sao Paulo Office
Rua Itapeva, 26 - 3° andar Edificio Itapeva One-Bela Vista
01332-000-São Paulo-SP-Brazil
TEL: +55 11 3568-3855 / FAX: +55 11 3568-3865

Europe

Deltronics (The Netherlands) B.V.
Eindhoven Office
De Witbogt 20, 5652 AG Eindhoven, The Netherlands
TEL: 31-40-2592850 / FAX: 31-40-2592851

*We reserve the right to change the information in this user manual without prior notice. 2017-03-15



Delta Elevator Drive VFD-ED Series User Manual



www.deltaww.com

Thank you for choosing DELTA's high-performance VFD-ED Series. The VFD-ED Series is manufactured with high-quality components and materials and incorporates the latest microprocessor technology available.

This manual is to be used for the installation, parameter setting, troubleshooting, and daily maintenance of the AC motor drive. To guarantee safe operation of the equipment, read the following safety guidelines before connecting power to the AC motor drive. Keep this operating manual at hand and distribute to all users for reference.

To ensure the safety of operators and equipment, only qualified personnel familiar with AC motor drive are to do installation, start-up and maintenance. Always read this manual thoroughly before using VFD-ED series AC Motor Drive, especially the WARNING, DANGER and CAUTION notes. Failure to comply may result in personal injury and equipment damage. If you have any question, please contact your dealer.

PLEASE READ PRIOR TO INSTALLATION FOR SAFETY.



1. AC input power must be disconnected before any wiring to the AC motor drive is made.
2. A charge may still remain in the DC-link capacitors with hazardous voltages, even if the power has been turned off. To prevent personal injury, please ensure that power has turned off before opening the AC motor drive and wait ten minutes for the capacitors to discharge to safe voltage levels.
3. Never reassemble internal components or wiring.
4. The AC motor drive may be destroyed beyond repair if incorrect cables are connected to the input/output terminals. Never connect the AC motor drive output terminals U/T1, V/T2, and W/T3 directly to the AC mains circuit power supply.
5. Ground the VFD-ED using the ground terminal. The grounding method must comply with the laws of the country where the AC motor drive is to be installed. Refer to the Basic Wiring Diagram.
6. VFD-ED series is used only to control variable speed of 3-phase induction motors, NOT for 1-phase motors or other purpose.
7. VFD-ED series shall NOT be used for life support equipment or any life safety situation.



1. DO NOT use Hi-pot test for internal components. The semi-conductor used in AC motor drive easily damage by high-voltage.
2. There are highly sensitive MOS components on the printed circuit boards. These components are especially sensitive to static electricity. To prevent damage to these components, do not touch these components or the circuit boards with metal objects or your bare hands.
3. Only qualified persons are allowed to install, wire and maintain AC motor drives.



1. Some parameters settings can cause the motor to run immediately after applying power.
2. DO NOT install the AC motor drive in a place subjected to high temperature, direct sunlight, high humidity, excessive vibration, corrosive gases or liquids, or airborne dust or metallic particles.
3. Only use AC motor drives within specification. Failure to comply may result in fire, explosion or electric shock.
4. To prevent personal injury, please keep children and unqualified people away from the equipment.
5. When the motor cable between AC motor drive and motor is too long, the layer insulation of the motor may be damaged. Please use a frequency inverter duty motor or add an AC output reactor to prevent damage to the motor. Refer to appendix B Reactor for details.
6. The rated voltage for AC motor drive must be $\leq 240V$ ($\leq 480V$ for 460V models) and the mains supply current capacity must be $\leq 5000A$ RMS ($\leq 10000A$ RMS for the $\geq 40hp$ (30kW) models)

Firmware version: 1.04

Table of Contents

| | |
|----------------------------------------------------------------------|------------|
| CHAPTER 1 INTRODUCTION | 1-1 |
| 1-1 Receiving and Inspection..... | 1-1 |
| 1-2 Nameplate Information..... | 1-1 |
| 1-3 Model Name..... | 1-1 |
| 1-4 Serial Number..... | 1-1 |
| 1-5 RFI Switch..... | 1-2 |
| 1-6 Dimensions..... | 1-6 |
| CHAPTER 2 INSTALLATION | 2-1 |
| 2-1 Minimum Mounting Clearance and Installation..... | 2-1 |
| 2-2 Minimum Mounting Clearance..... | 2-2 |
| CHAPTER 3 WIRING | 3-1 |
| 3-1 Wiring..... | 3-2 |
| 3-2 System Wiring Diagram..... | 3-5 |
| CHAPTER 4 MAIN CIRCUIT TERMINALS | 4-1 |
| 4-1 Main Circuit Diagram..... | 4-1 |
| 4-2 Main Circuit Terminals..... | 4-3 |
| CHAPTER 5 CONTROL TERMINALS | 5-1 |
| 5-1 Remove the Cover before Wiring..... | 5-1 |
| 5-2 Specification of the Control Terminals..... | 5-3 |
| 5-3 Control Circuit Terminal Sockets..... | 5-3 |
| CHAPTER 6 OPTIONAL ACCESSORIES | 6-1 |
| 6-1 All Brake Resistors and Brake Units Used in AC Motor Drives..... | 6-1 |
| 6-2 Non-fuse Circuit Breaker..... | 6-4 |
| 6-3 Fuse Specification Chart | 6-4 |
| 6-4 AC/DC Reactor..... | 6-5 |
| 6-5 Zero Phase Reactor..... | 6-7 |
| 6-6 EMI Filter..... | 6-10 |
| 6-7 Digital Keypad..... | 6-13 |
| 6-8 USB/RS-485 Communication Interface IFD6530..... | 6-16 |
| CHAPTER 7 OPTION CARDS | 7-1 |
| Remove the top cover..... | 7-1 |
| Screws' Specification for Option Card Terminals..... | 7-2 |
| 7-1 EMED-PGABD-1..... | 7-3 |
| 7-2 EMED-PGHSD-1..... | 7-7 |

| | |
|----------------------------------------------------------------------------------------|-------------|
| CHAPTER 8 SPECIFICATION | 8-1 |
| 8-1 230V Series..... | 8-1 |
| 8-2 460V Series..... | 8-1 |
| General Specifications..... | 8-2 |
| CHAPTER 9 DIGITAL KEYPAD | 9-1 |
| 9-1 Descriptions of Digital Keypad | 9-1 |
| 9-2 Operating the Built-in Digital Keypad | 9-3 |
| 9-3 Description of Digital Keypad KPC-CC01 | 9-4 |
| 9-4 Function of Digital Keypad KPC-CC01 | 9-6 |
| 9-5 Fault Code Description of Digital Keypad KPC-CC01 | 9-18 |
| 9-6 TPEditor Installation | 9-22 |
| CHAPTER 10 AUTO-TUNING PROCESS | 10-1 |
| CHAPTER 11 SUMMARY OF PARAMETERS | 11-1 |
| CHAPTER 12 DESCRIPTION OF PARAMETER SETTINGS | 12-1 |
| CHAPTER 13 WARNING CODES | 13-1 |
| CHAPTER 14 FAULT CODES | 14-1 |
| CHAPTER 15 SUGGESTION & ERROR CORRECTIONS FOR STANDARD AC MOTOR DRIVES | 15-1 |
| CHAPTER 16 FUNCTION OF SAFETY TORQUE OFF | 16-1 |
| APPENDIX A. AC MOTOR DRIVES EMC STANDARD INSTALLATION GUIDE | i |

Please include the Issue Edition and the Firmware Version, both shown below, when communicating with Technical Support regarding this publication.

Firmware Version: 1.04

Issue date: November 2016

| |
|---------------------|
| Publication History |
|---------------------|

A. Modifications

1. Add Pr.06-45 bit2 so that users can enable or disable the GFF software protection.
2. Modify Pr 03-17 =21 to "Power Output"
3. Certain faults might occur during the auto-tuning process.
Those faults not related to the auto-tuning process will have their own faults codes displayed.
4. Divide PGF5 into 3 different fault codes:
 - PGF5: PG hardware error
 - PGAF: PG Z phase signal error
 - PGHL: PG loss pin is pulled low
5. Modify the format of Pr02-10 and Pr02-23 to hexadecimal.
6. Group 13 <View User Defined Parameters> can be read on the keypad KPE-LLE01.
7. Modify the conditions to estimate if a fault is a PGAF fault.
8. Modify the STO fault code to be the same as that of the standard models.

B. New Functions

1. Add "Auto reset" function : Faults such as ovA, ovd, ovn, ovS, LvA, Lvd, Lvn, LvS and PHL can be auto reset. Refer to the following new added parameters:

Pr06-50: Selection of MO's action when retrying after fault

Pr06-51: Number of times of retrying after fault

Pr06-52: Time interval between retrying

2. Fault <MBF> can only be erased by reset manually. This fault cannot be erased by simply power down then power on the motor drive.

3. Add:

Pr06-49= 2: STO Latch (Warn and record running commands when stop).

Pr06-49= 3: STO No Latch (Warn and record running commands when stop)

4. Add:

Pr05-05 No-load Current of Motor <0~ Pr05-01 <factory setting>> to provide accurate control in slip compensation at different power ratings.

5. Divide DC brake current level into two situations.

Modify Pr07-02 to <DC brake current level **during start-up**>;

Add Pr07-30 <DC brake current level **during stop**>

The factory setting of these two parameters is the same.

6. Add Pr10-31 so that users can interchange the C+/C- pin for encoder ENR1387 instead of re-wiring the C+/C- pin.

7. The direct docking mode has been added to several parameters. Since this is not a standard function for general elevator application. Contact for more information.

Please include the Issue Edition and the Firmware Version, both shown below, when communicating with Technical Support regarding this publication.

Firmware Version: 1.04

Issue date: March 2017

| |
|---------------------|
| Publication History |
|---------------------|

A. Modifications

1. Modify Bit 12 to 1: Enable bit 06-11 (Ch12, 3.5 Address List)
2. Modify the parameter setting of preload input to Pr03-00=3, Pr07-19=1, Pr03-03, Pr03-06 and Pr03-09.
3. Modify Ch11 Pr06-16 to Pr06-21 in accordance with Ch14 Fault Codes
4. Modify Ch12 Pr06-16 to Pr06-21, Pr06-22 to Pr06-25 and Pr06-30 in accordance with Ch14 Fault Codes.
5. Modify 16-6 Fault codes related to STO in accordance with Ch14 Fault Codes.

01 Introduction

1-1 Receiving and Inspection

After receiving the AC motor drive, please check for the following:

- 1) Inspect the unit after unpacking to assure it was not damaged during shipment. Make sure that the part number printed on the package corresponds with the part number indicated on the nameplate.
- 2) Make sure that the voltage for the wiring lie within the range as indicated on the nameplate. Install the AC motor drive according to this manual.
- 3) Before applying the power, make sure that all the devices, including power, motor, control board and digital keypad, are connected correctly.
- 4) When wiring the AC motor drive, make sure that the wiring of input terminals "R/L1, S/L2, T/L3" and output terminals "U/T1, V/T2, W/T3" are correct to prevent drive damage.
- 5) When power is applied, select the language and set parameter groups via the digital keypad (KPED-LE01). When executing a trial run, begin with a low speed and then gradually increase the speed until the desired speed is reached.

1-2 Nameplate Information

Using 15HP/11kW 230V, 3-Phase as an example.

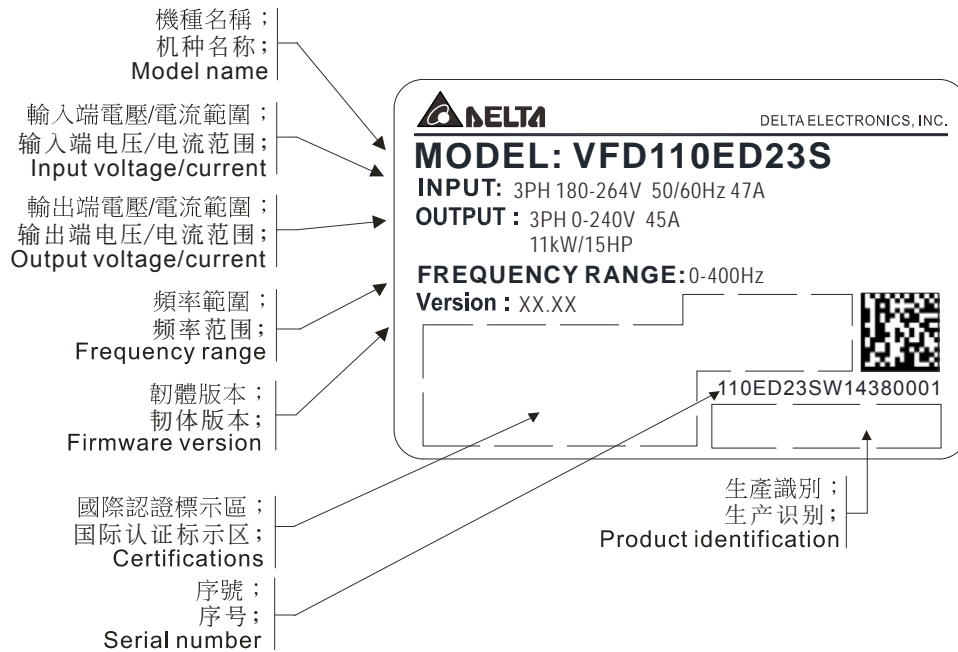

1-3 Model Name

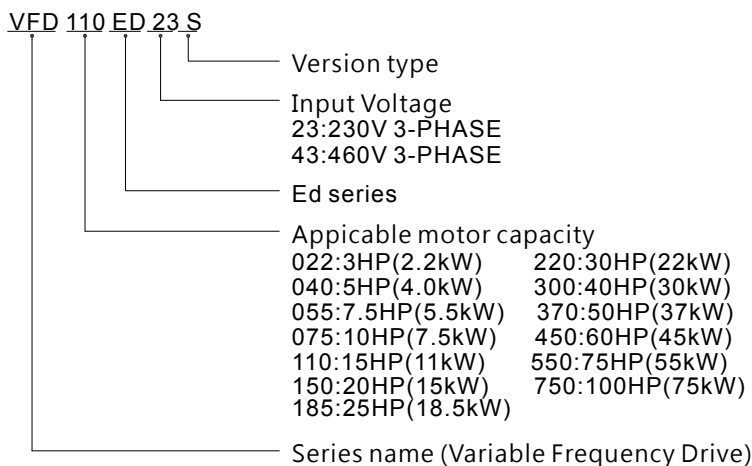

1-4 Serial Number

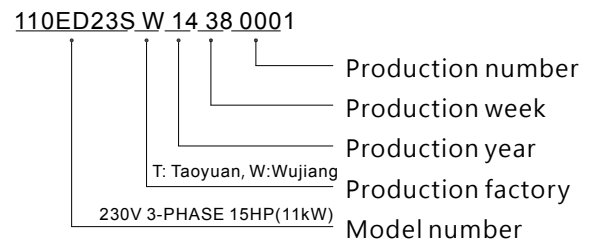

1-5 RFI Switch

The AC motor drive may emit the electrical noise. The RFI switch is used to suppress the interference (Radio Frequency Interference) on the power line. The RFI Switch of Frame C, D, E are at similar position (Frame B doesn't have a RFI Switch). Open the top cover to remove the RFI switch as shown in the image below.

Frame E

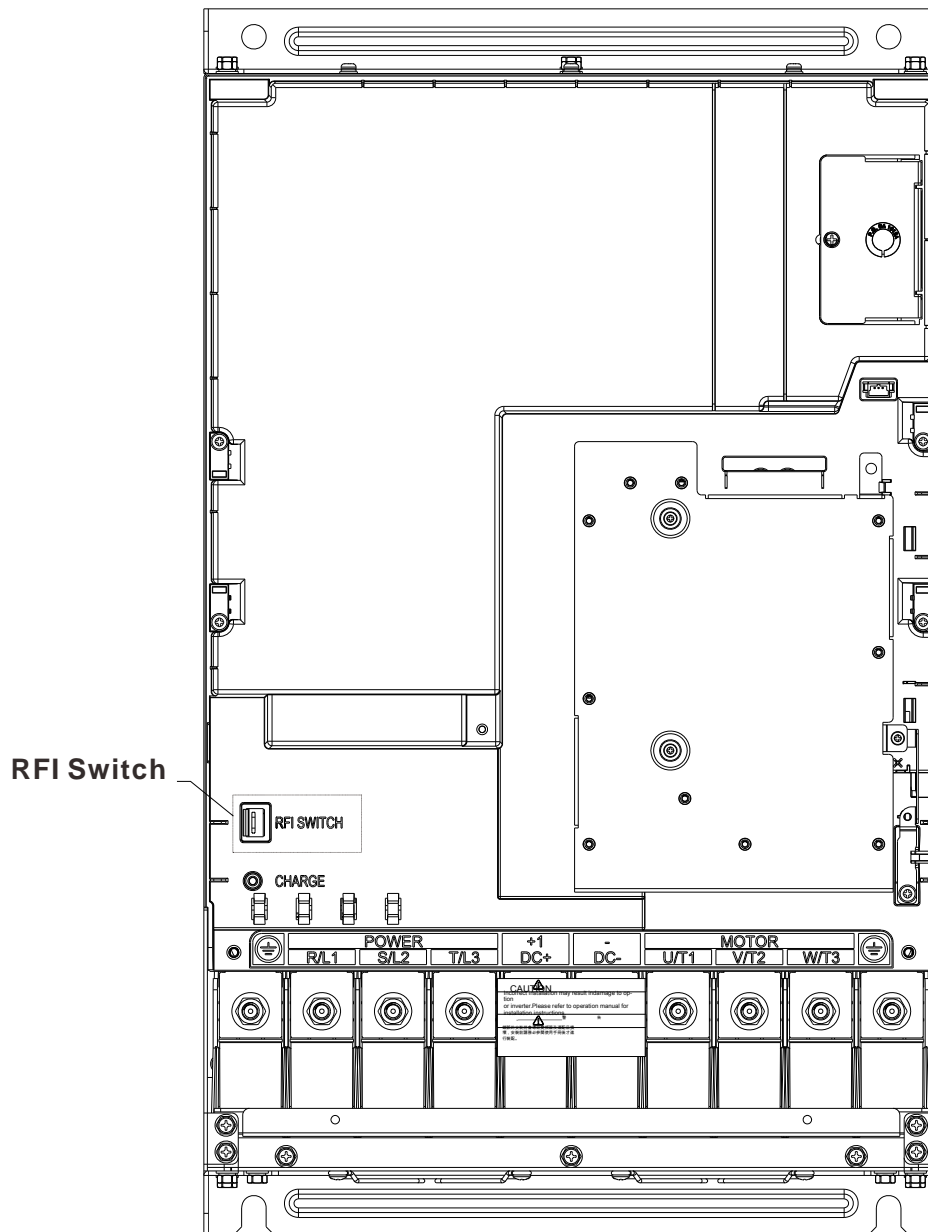

Isolating main power from ground:

When the power distribution system of the Power Regenerative Unit is a floating ground system (IT) or an asymmetric ground system (TN), the RFI short-circuit cable must be cut off. Cutting off the short-circuit cable also cuts off the internal RFI capacitor (filter capacitor) between the system's frame and the central circuits to avoid damaging the central circuits and (according to IEC 61800-3) reduce the ground leakage current.

Important points regarding ground connection

- ☑ To ensure the safety of personnel, proper operation, and to reduce electromagnetic radiation, the Power Regenerative Unit must be properly grounded during installation.
- ☑ The diameter of the cables must meet the size specified by safety regulations.
- ☑ The shielded cable must be connected to the ground of the Power Regenerative Unit to meet safety regulations.
- ☑ The shielded cable can only be used as the ground for equipment when the aforementioned points are met.
- ☑ When installing multiple sets of Power Regenerative Units, do not connect the grounds of the Power Regenerative Units in series. As shown below

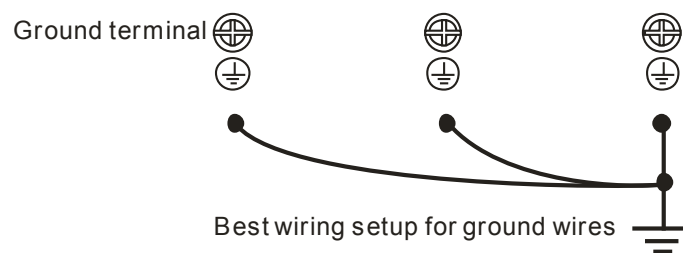

Pay particular attention to the following points:

- ☑ After turning on the main power, do not cut the RFI short-circuit cable while the power is on.
- ☑ Make sure the main power is turned off before cutting the RFI short-circuit cable.
- ☑ Cutting the RFI short-circuit cable will also cut off the conductivity of the capacitor. Gap discharge may occur once the transient voltage exceeds 1000V.

If the RFI short-circuit cable is cut, there will no longer be reliable electrical isolation. In other words, all controlled input and outputs can only be seen as low-voltage terminals with basic electrical isolation. Also, when the internal RFI capacitor is cut off, the Power Regenerative Unit will no longer be electromagnetic compatible.

- ☑ The RFI short-circuit cable may not be cut off if the main power is a grounded power system.
- ☑ The RFI short-circuit cable may not be cut off while conducting high voltage tests. When conducting a high voltage test to the entire facility, the main power and the motor must be disconnected if leakage current is too high.

Floating Ground System (IT Systems)

A floating ground system is also called IT system, ungrounded system, or high impedance/resistance (greater than 30Ω) grounding system.

- ☑ Disconnect the ground cable from the internal EMC filter.
- ☑ In situations where EMC is required, check whether there is excess electromagnetic radiation affecting nearby low-voltage circuits. In some situations, the adapter and cable naturally provide enough suppression. If in doubt, install an extra electrostatic shielded cable on the power supply side between the main circuit and the control terminals to increase security.
- ☑ Do not install an external RFI/EMC filter, the EMC filter will pass through a filter capacitor, thus connecting power input to ground. This is very dangerous and can easily damage the Power Regenerative Unit.

Asymmetric Ground System (Corner Grounded TN Systems)

Caution: Do not cut the RFI short-circuit cable while the input terminal of the Power Regenerative Unit carries power.

In the following four situations, the RFI short-circuit cable must be cut off. This is to prevent the system from grounding through the RFI capacitor, damaging the Power Regenerative Unit.

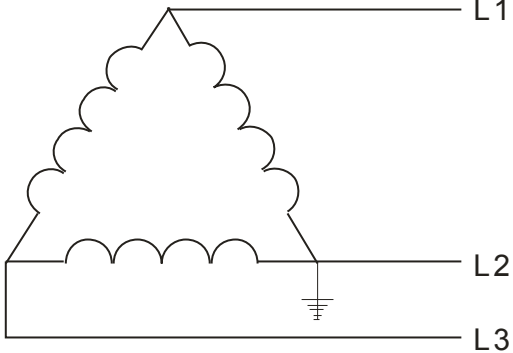
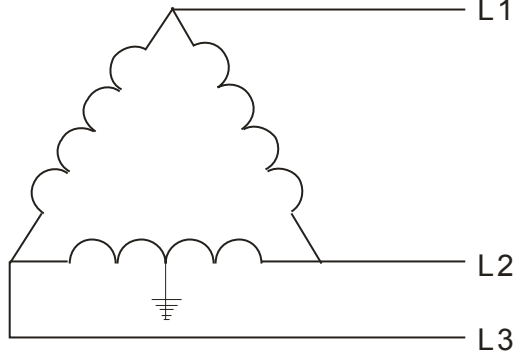
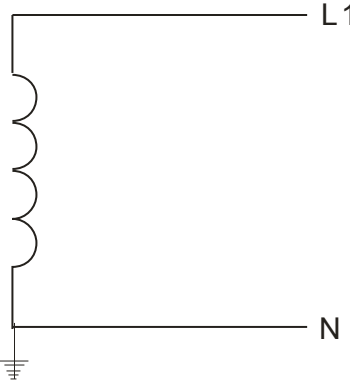
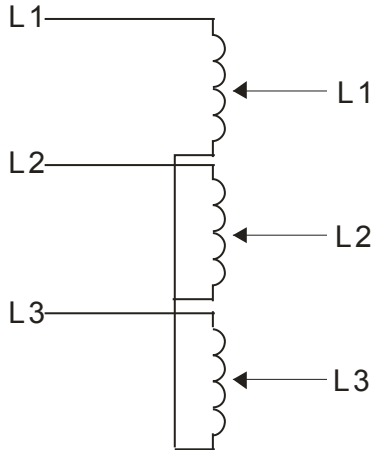
| RFI short-circuit cable must be cut off | |
|----------------------------------------------------------------------------------------------------------------------------------------------------|---------------------------------------------------------------------------------------------------------------------------------------------------------------------------|
| <p>1. Grounding at a corner in a triangle configuration</p>  | <p>2. Grounding at a midpoint in a polygonal configuration</p>  |
| <p>3. Grounding at one end in a single-phase configuration</p>  | <p>4. No stable neutral grounding in a three-phase autotransformer configuration</p>  |

Use RFI short-circuit

Internal grounding through RFI capacitor, which reduces electromagnetic radiation. In a situation with higher requirements for electromagnetic compatibility, and using a symmetrical grounding power system, an EMC filter can be installed. For example, the diagram on the right is a symmetrical grounding power system.

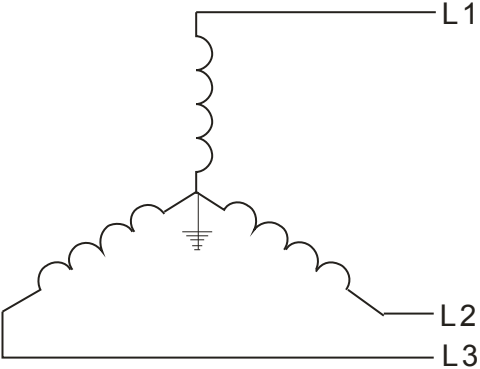

1-6 Dimensions

Frame B

VFD022ED21S, VFD037ED21S, VFD040ED23S/43S;

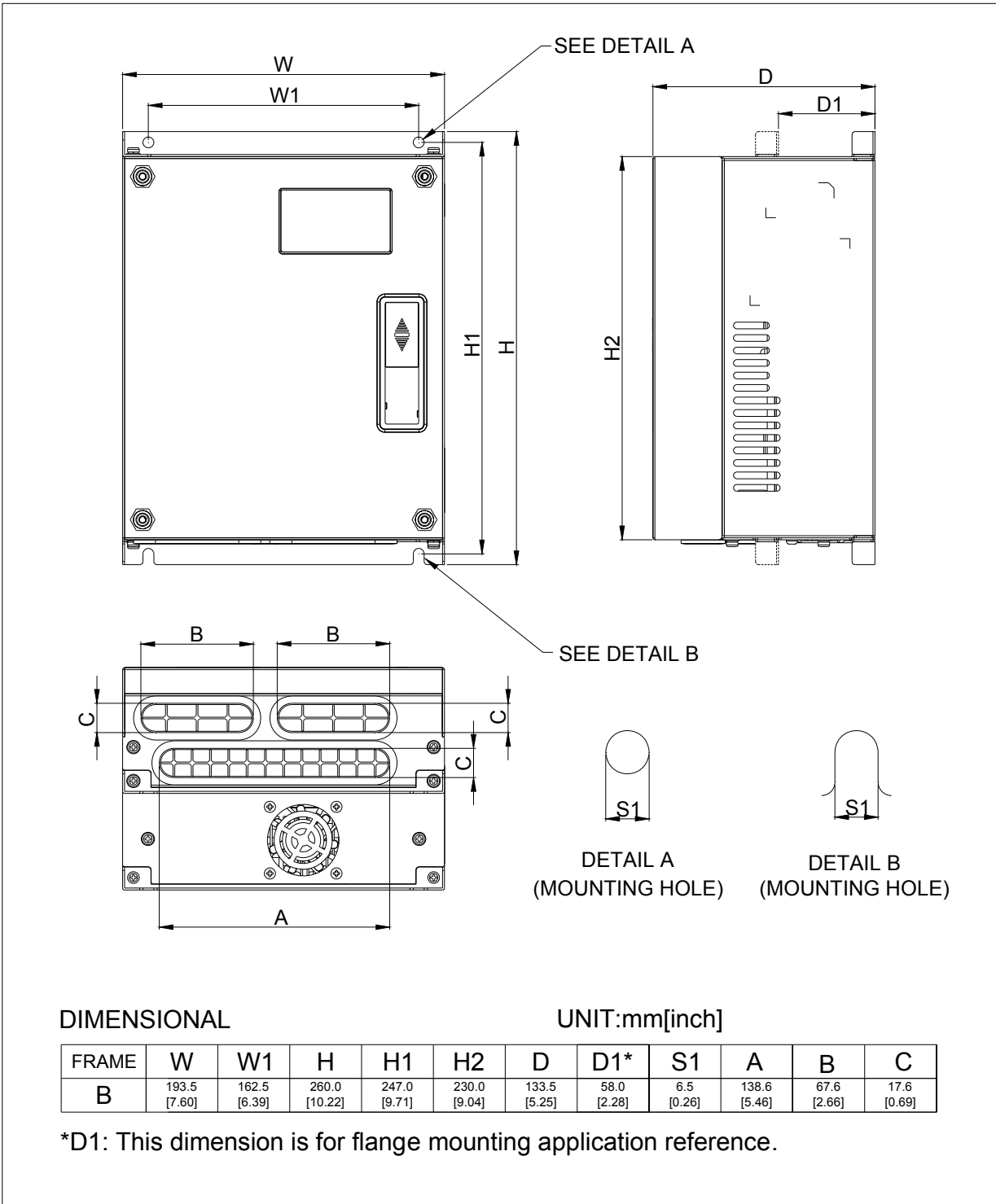

Frame C

VFD055ED23S/43S, VFD075ED23S/43S, VFD110ED23S/43S, VFD150ED43S, VFD185ED43S;

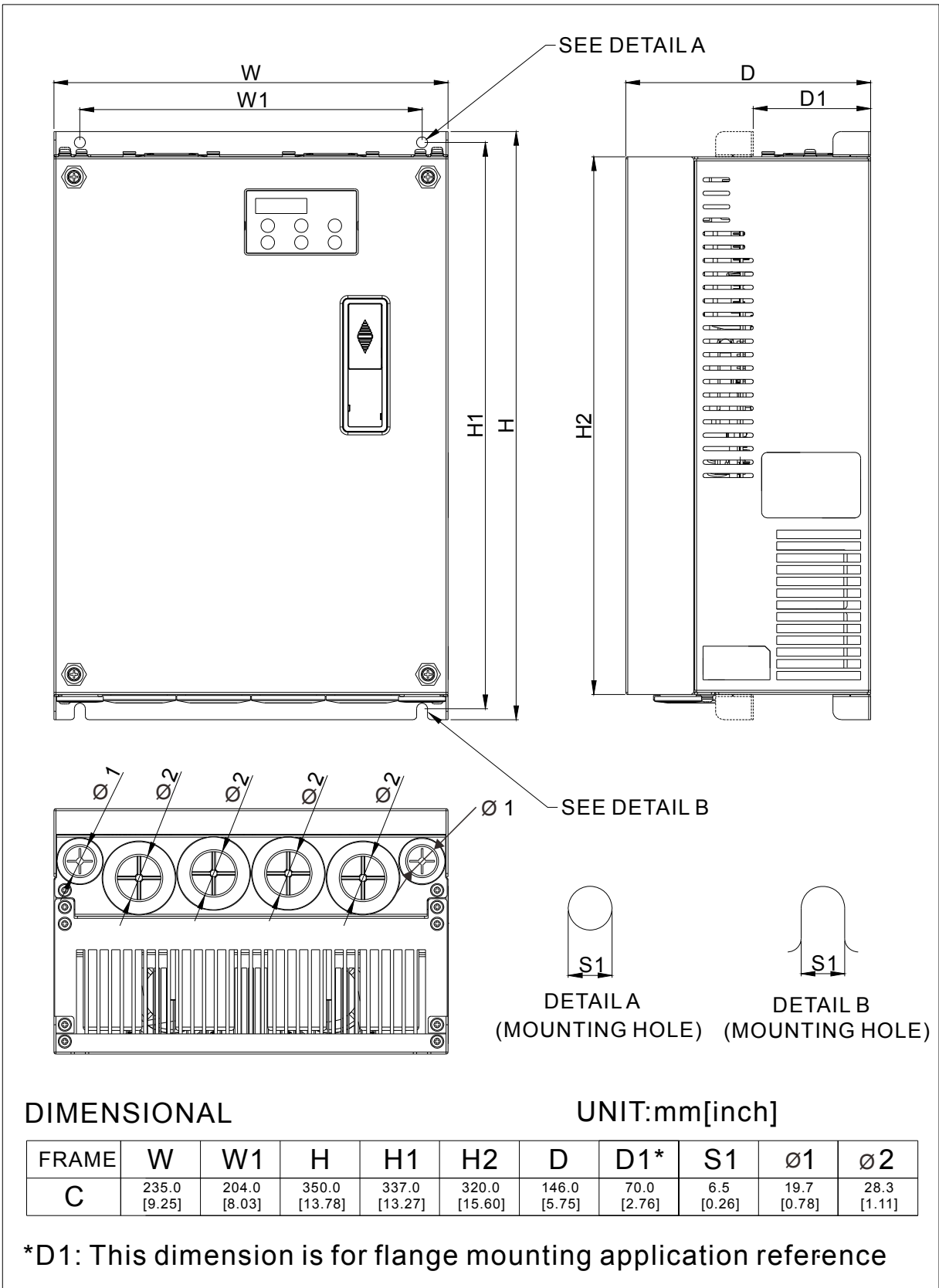

Frame D

VFD150ED23S, VFD185ED23S, VFD220ED23S/43S, VFD300ED43S;

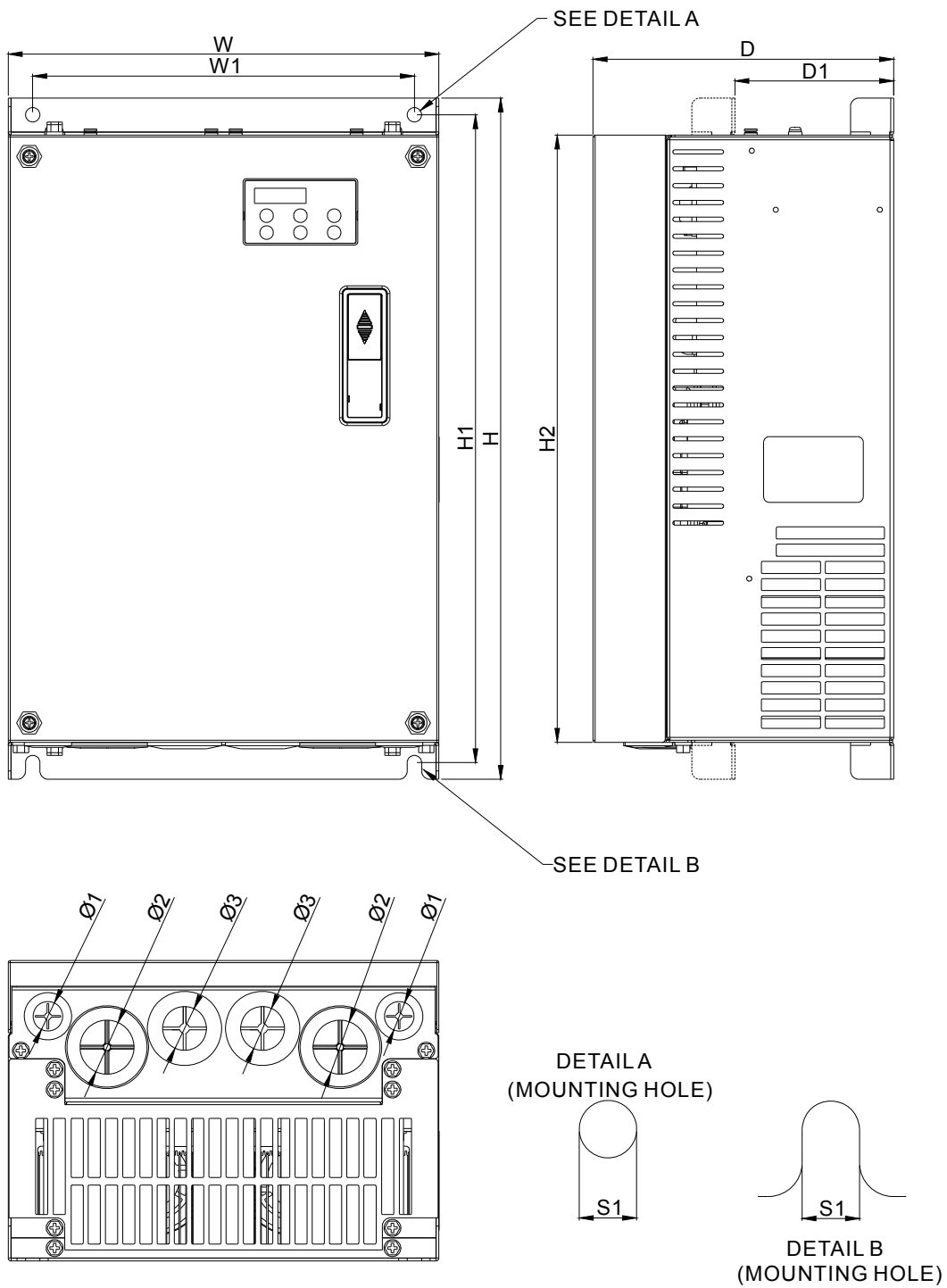

DIMENSIONAL

UNIT:mm[inch]

| FRAME | W | W1 | H | H1 | H2 | D | D1* | S1 | Ø1 | Ø2 | Ø3 |
|-------|------------------|-----------------|------------------|------------------|------------------|-----------------|----------------|---------------|----------------|----------------|----------------|
| D | 255.0 [10.04] | 226.0 [8.90] | 403.8 [15.90] | 384.0 [15.12] | 360.0 [14.17] | 178.0 [7.01] | 94.0 [3.70] | 8.5 [0.33] | 17.5 [0.69] | 32.0 [1.26] | 26.0 [1.02] |

*D1: This dimension is for flange mounting application reference

Frame E

VFD300ED23S, VFD370ED23S/43S, VFD450ED43S, VFD550ED43S, VFD750ED43S;

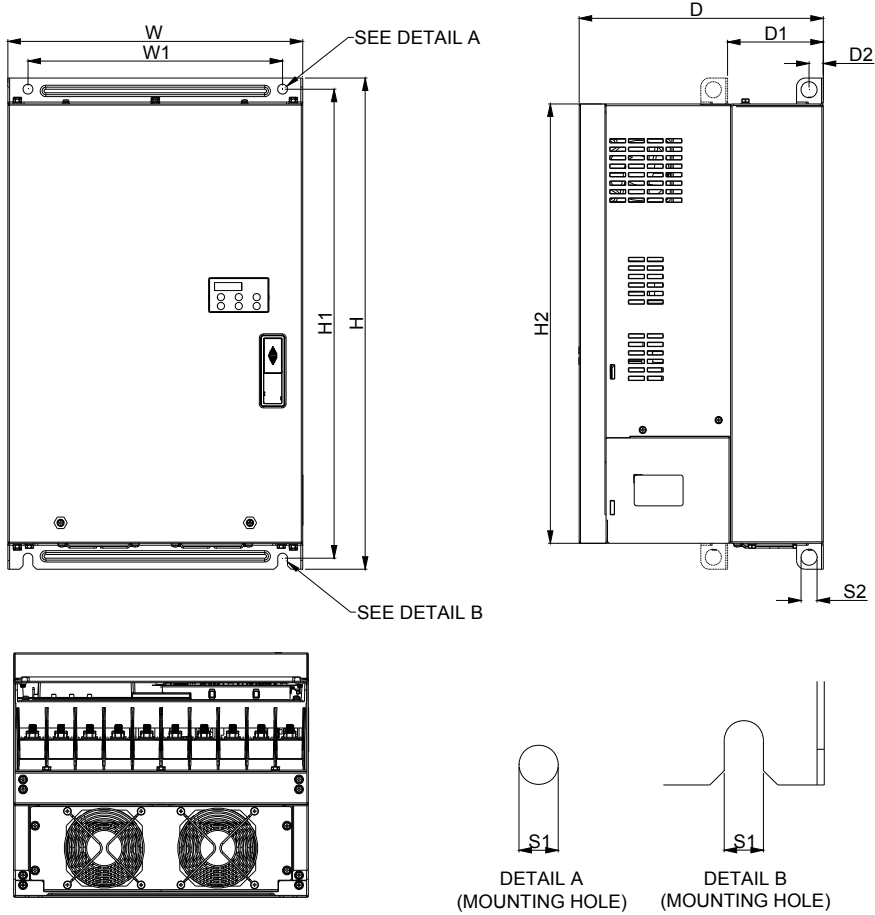

DIMENSIONAL

UNIT:mm[inch]

| FRAME | W | W1 | H | H1 | H2 | D | D1* | D2 | S1 | S2 |
|-------|------------------|------------------|------------------|------------------|------------------|------------------|-----------------|----------------|----------------|----------------|
| E | 330.0 [12.99] | 285.0 [11.22] | 550.0 [21.65] | 525.0 [20.67] | 492.0 [19.37] | 273.4 [10.76] | 107.2 [4.22] | 16.0 [0.63] | 11.0 [0.43] | 18.0 [0.71] |

*D1: This dimension is for flange mounting application reference.

Built-In Digital Keypad
KPED-LE01

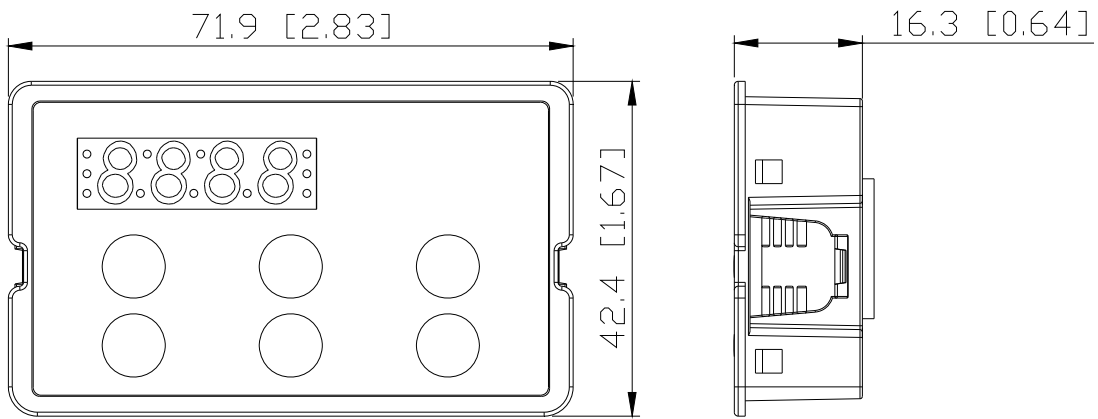

02 Installation

2-1 Minimum Mounting Clearance and Installation



- ☑ Prevent fiber particles, scraps of paper, shredded wood saw dust, metal particles, etc. from adhering to the heat sink
- ☑ Install the AC motor drive in a metal cabinet. When installing one drive below another one, use a metal separation between the AC motor drives to prevent mutual heating and to prevent the risk of fire accident.
- ☑ Install the AC motor drive in Pollution Degree 2 environments only: normally only nonconductive pollution occurs and temporary conductivity caused by condensation is expected.

The image below is for reference only.

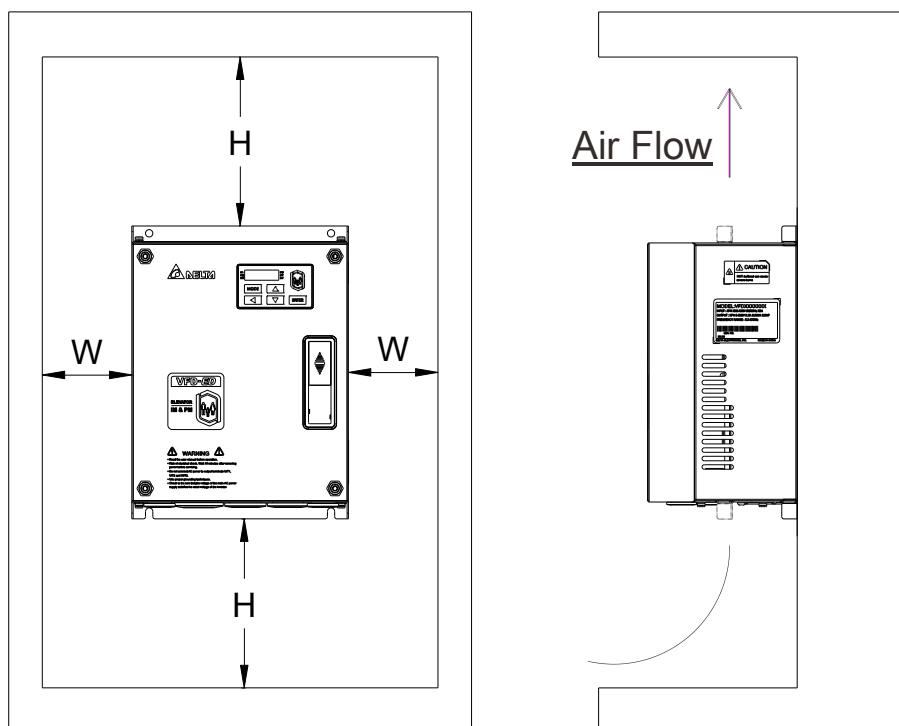

2-2 Minimum mounting clearance

| Horsepower | Width | Height |
|------------|-----------|-----------|
| | mm (inch) | mm (inch) |
| 3-5HP | 50 (2) | 150 (6) |
| 7.5-20HP | 75 (3) | 175 (7) |
| 25-30HP | 75 (3) | 200 (8) |
| 40-100HP | 75(3) | 200(8) |

| Frame | Capacity | Model No. |
|----------|------------------------|-------------------------------------------------------------------------------|
| B | 3.0-5.0HP (2.2-4kW) | VFD022ED21S, VFD037ED21S,VFD040ED23S/43S |
| C | 7.5-15HP (5.5-11kW) | VFD055ED23S/43S, VFD075ED23S/43S,VFD110ED23S/43S, VFD150ED43S, VFD185ED43S |
| D | 20-40HP (15-30kW) | VFD150ED23S, VFD185ED23S, VFD220ED23S/43S VFD300ED43S |
| E | 40-100HP (30-75kW) | VFD300ED23S, VFD370ED23S/43S, VFD450ED43S, VFD550ED43S, VFD750ED43S |

 **NOTE**

The minimum mounting clearances stated in the table above applies to AC motor drives frame B, C, D and E. A drive which fails to follow the minimum mounting clearances may cause the fan to malfunction and heat dissipation problem.

| Model No. | Air flow rate for cooling | | | | | | Power Dissipation AC motor drive | | |
|-------------|---------------------------|----------|-------|------------------|----------|-------|----------------------------------|----------|-------|
| | Flow Rate(cfm) | | | Flow Rate(m3/hr) | | | Power Dissipation | | |
| | External | Internal | Total | External | Internal | Total | Loss External (Heat Sink) | Internal | Total |
| VFD022ED21S | 13.7 | - | 13.7 | 23.3 | - | 23.3 | 60 | 36 | 96 |
| VFD037ED21S | 23.9 | - | 23.9 | 40.7 | - | 40.7 | 84 | 46 | 130 |
| VFD040ED23S | 23.9 | - | 23.9 | 40.7 | - | 40.7 | 133 | 49 | 182 |
| VFD055ED23S | 48.5 | - | 48.5 | 82.4 | - | 82.4 | 212 | 67 | 279 |
| VFD075ED23S | 48.5 | - | 48.5 | 82.4 | - | 82.4 | 292 | 86 | 379 |
| VFD110ED23S | 47.9 | - | 47.9 | 81.4 | - | 81.4 | 355 | 121 | 476 |
| VFD150ED23S | 64.6 | - | 64.6 | 109.8 | - | 109.8 | 490 | 161 | 651 |
| VFD185ED23S | 102.3 | - | 102.3 | 173.8 | - | 173.8 | 638 | 184 | 822 |
| VFD220ED23S | 102.8 | - | 102.8 | 174.7 | - | 174.7 | 723 | 217 | 939 |
| VFD300ED23S | 179 | 30 | 209 | 304 | 51 | 355 | 932 | 186 | 1118 |
| VFD370ED23S | 179 | 30 | 209 | 304 | 51 | 355 | 1112 | 222 | 1334 |
| VFD040ED43S | 13.7 | - | 13.7 | 23.3 | - | 23.3 | 123 | 42 | 165 |
| VFD055ED43S | 48.5 | - | 48.5 | 82.4 | - | 82.4 | 185 | 55 | 240 |
| VFD075ED43S | 48.5 | - | 48.5 | 82.4 | - | 82.4 | 249 | 71 | 320 |

| | | | | | | | | | |
|-------------|-------|----|-------|-------|----|-------|------|-----|------|
| VFD110ED43S | 47.9 | - | 47.9 | 81.4 | - | 81.4 | 337 | 94 | 431 |
| VFD150ED43S | 46.1 | - | 46.1 | 78.4 | - | 78.4 | 302 | 123 | 425 |
| VFD185ED43S | 46.1 | - | 46.1 | 78.4 | - | 78.4 | 391 | 139 | 529 |
| VFD220ED43S | 102.8 | - | 102.8 | 174.7 | - | 174.7 | 642 | 141 | 783 |
| VFD300ED43S | 83.7 | - | 83.7 | 142.2 | - | 142.2 | 839 | 180 | 1019 |
| VFD370ED43S | 179 | 30 | 209 | 304 | 51 | 355 | 803 | 252 | 1055 |
| VFD450ED43S | 179 | 30 | 209 | 304 | 51 | 355 | 1014 | 270 | 1284 |
| VFD550ED43S | 179 | 30 | 209 | 304 | 51 | 355 | 1244 | 275 | 1519 |
| VFD750ED43S | 186 | 30 | 216 | 316 | 51 | 367 | 1541 | 338 | 1878 |

Derating Capacity of Carrier Frequency (Fc):

| Frame | B | C | D | E | E |
|---------|----------|-----------|----------|----------|---------|
| Fc(kHz) | 2.2~4 kW | 5.5~11 kW | 15~22 kW | 30~45 kW | 55~75kW |
| 0 | 100% | 100% | 100% | 100% | 100% |
| 1 | 100% | 100% | 100% | 100% | 100% |
| 2 | 100% | 100% | 100% | 100% | 100% |
| 3 | 100% | 100% | 100% | 100% | 100% |
| 4 | 100% | 100% | 100% | 100% | 100% |
| 5 | 100% | 100% | 100% | 100% | 100% |
| 6 | 100% | 100% | 100% | 100% | 100% |
| 7 | 100% | 100% | 100% | 90.73% | - |
| 8 | 100% | 100% | 100% | 82.20% | - |
| 9 | 94.24% | 100% | 92.32% | 74.31% | - |
| 10 | 88.92% | 100% | 85.21% | - | - |
| 11 | 82.54% | 95.35% | 78.63% | - | - |
| 12 | 78.08% | 91.02% | 72.53% | - | - |
| 13 | 73.95% | 86.98% | 66.87% | - | - |
| 14 | 70.14% | 84.14% | 61.62% | - | - |
| 15 | 66.61% | 80.67% | 56.74% | - | - |

Derating Curve of Carrier Frequency (Fc):

Io derating curve

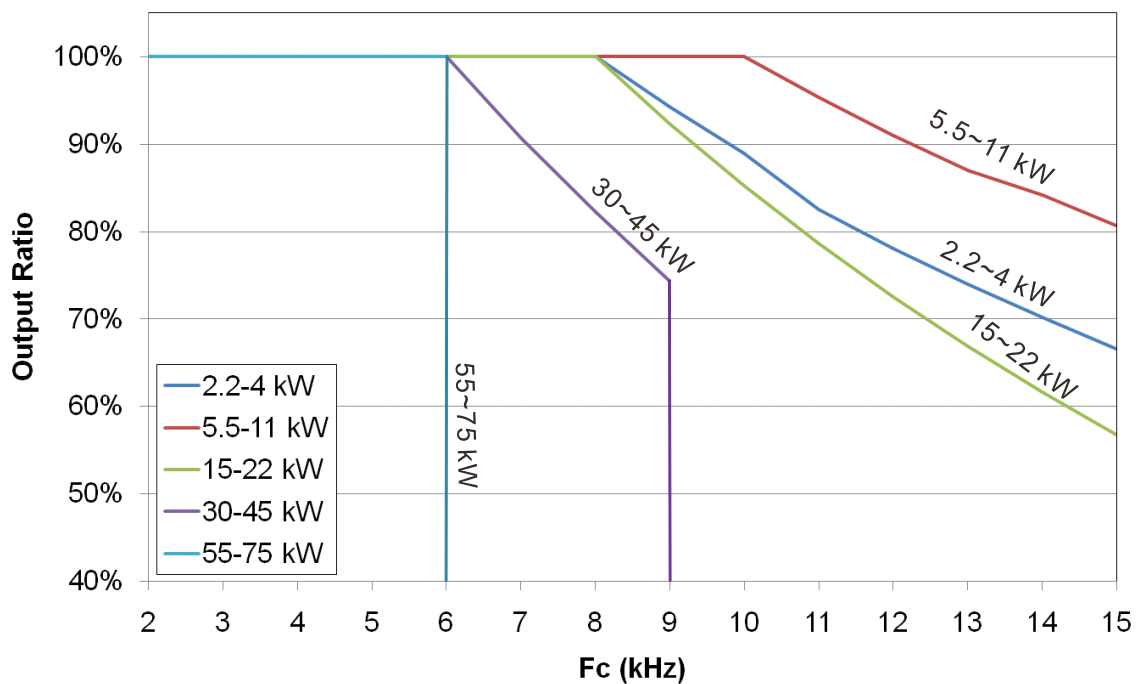

Ambient Temperature Derating Curve:

Temperature derating curve

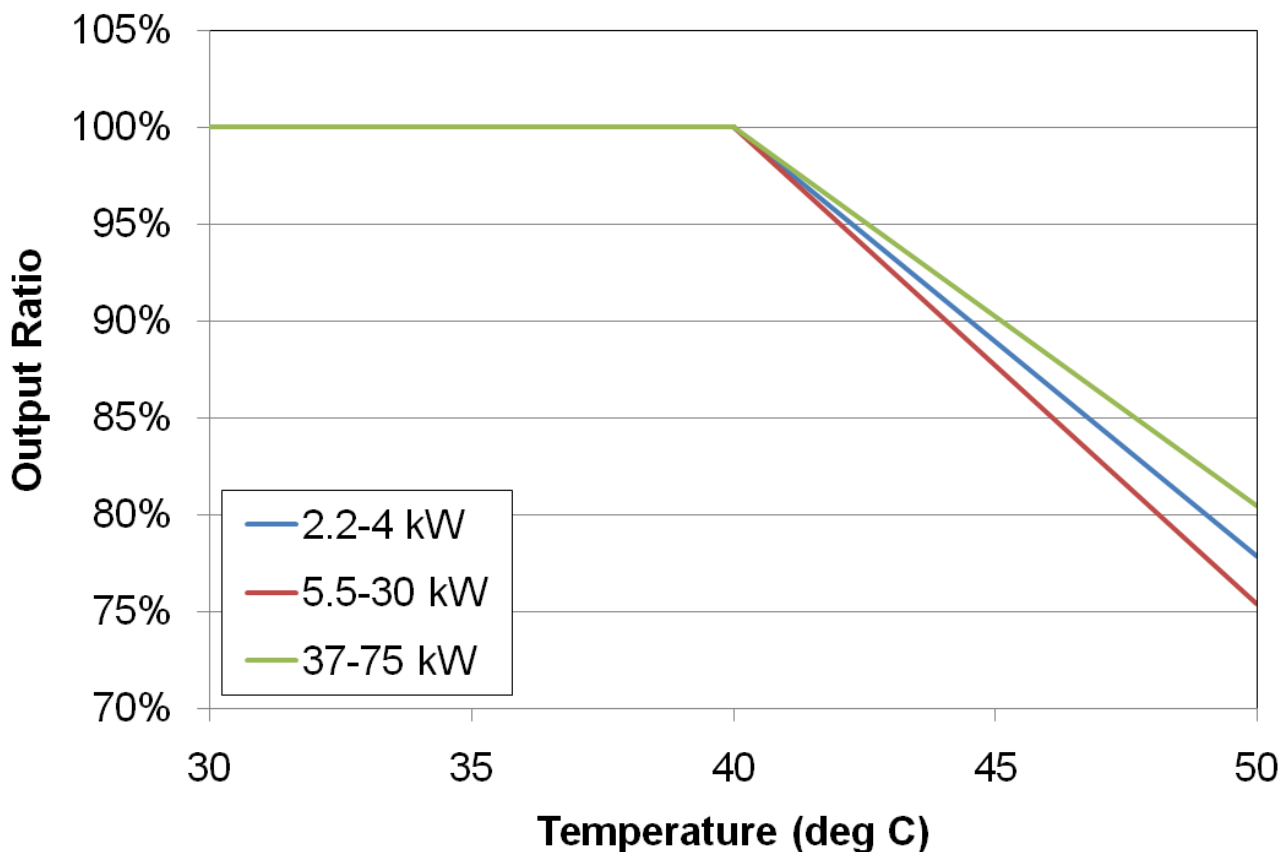

Altitude Derating Curve:

Altitude Derating Curve

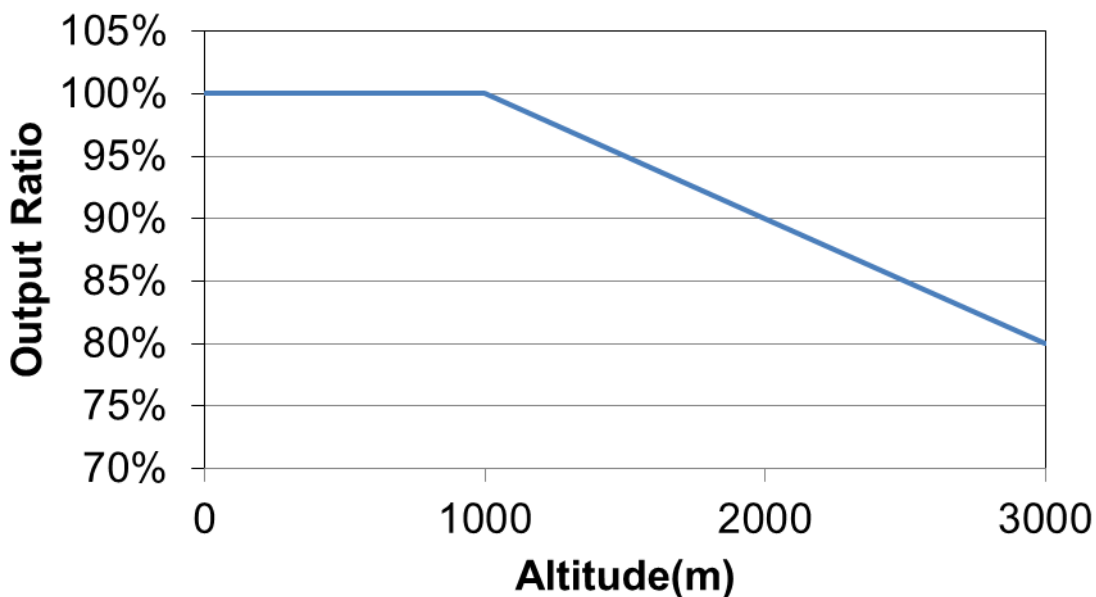

03 Wiring

After removing the front cover, examine if the power and control terminals are clearly noted. Read following precautions before wiring.

- ☑ Make sure that power is only applied to the R/L1, S/L2, and T/L3 terminals. Failure to comply may result in damage to the equipment. The voltage and current should lie within the range as indicated on the nameplate (Chapter 1-1).
- ☑ All the units must be grounded directly to a common ground terminal to prevent lightning strike or electric shock.
- ☑ Make sure to fasten the screw of the main circuit terminals to prevent sparks which is made by the loose screws due to vibration.



- ☑ It is crucial to turn off the AC motor drive power before any wiring installation is made. A charge may still remain in the DC bus capacitors with hazardous voltages even if the power has been turned off therefore it is suggested for users to measure the remaining voltage before wiring. For your personal safety, do not perform any wiring before the voltage drops to a safe level < 25 Vdc. Wiring installation with remaining voltage condition may cause sparks and short circuit.
- ☑ Only qualified personnel familiar with AC motor drives is allowed to perform installation, wiring and commissioning. Make sure the power is turned off before wiring to prevent electric shock.



- ☑ When wiring, please choose the wires with specification that comply with local regulation for your personal safety.
- ☑ Check following items after finishing the wiring:
 1. Are all connections correct?
 2. Any loosen wires?
 1. Any short-circuits between the terminals or to ground?

3-1 Wiring

Wiring Diagram of Frame B

It provides 3-phase power

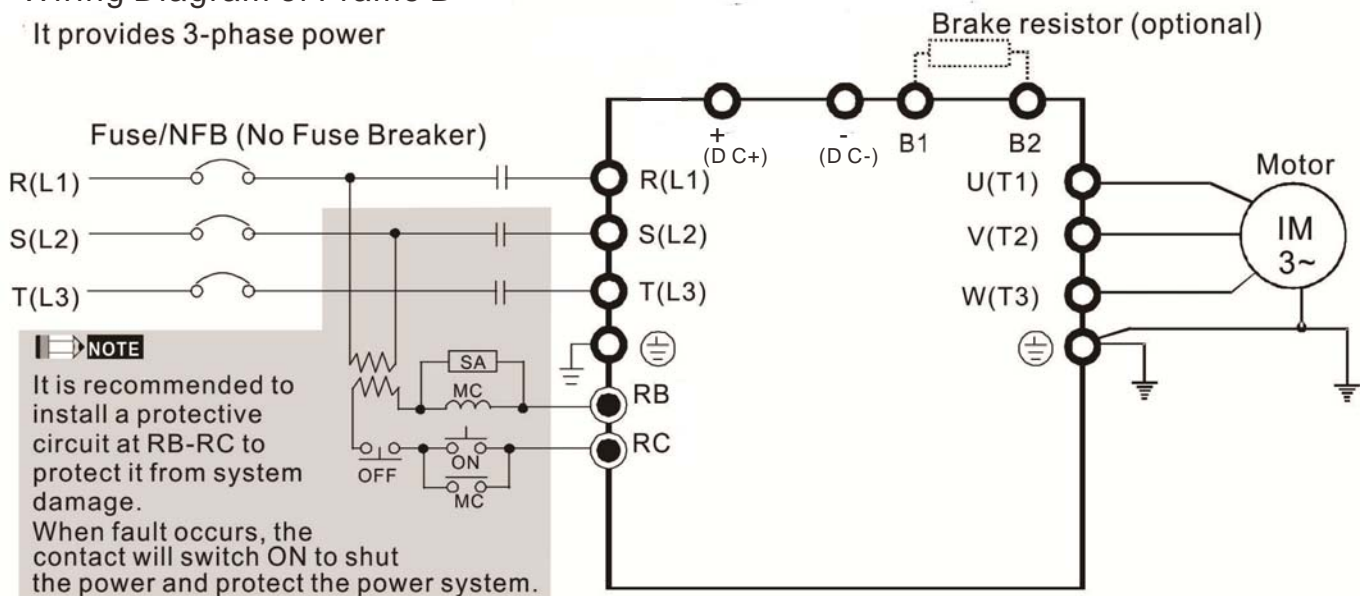

NOTE
RB and RC are the multifunction output terminals

Wiring Diagram of Frame C & D

It provides 3-phase power

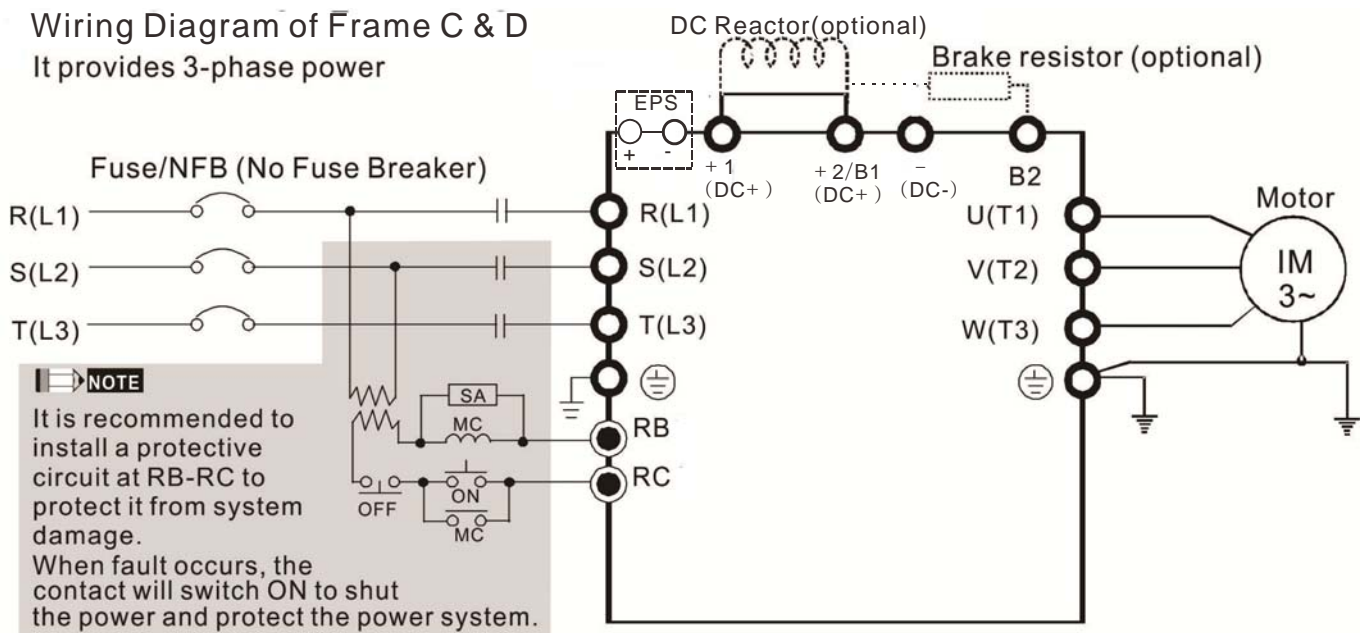

NOTE
RB and RC are the multi-function output terminals.

Wiring Diagram of Frame E

It provides 3-phase power.

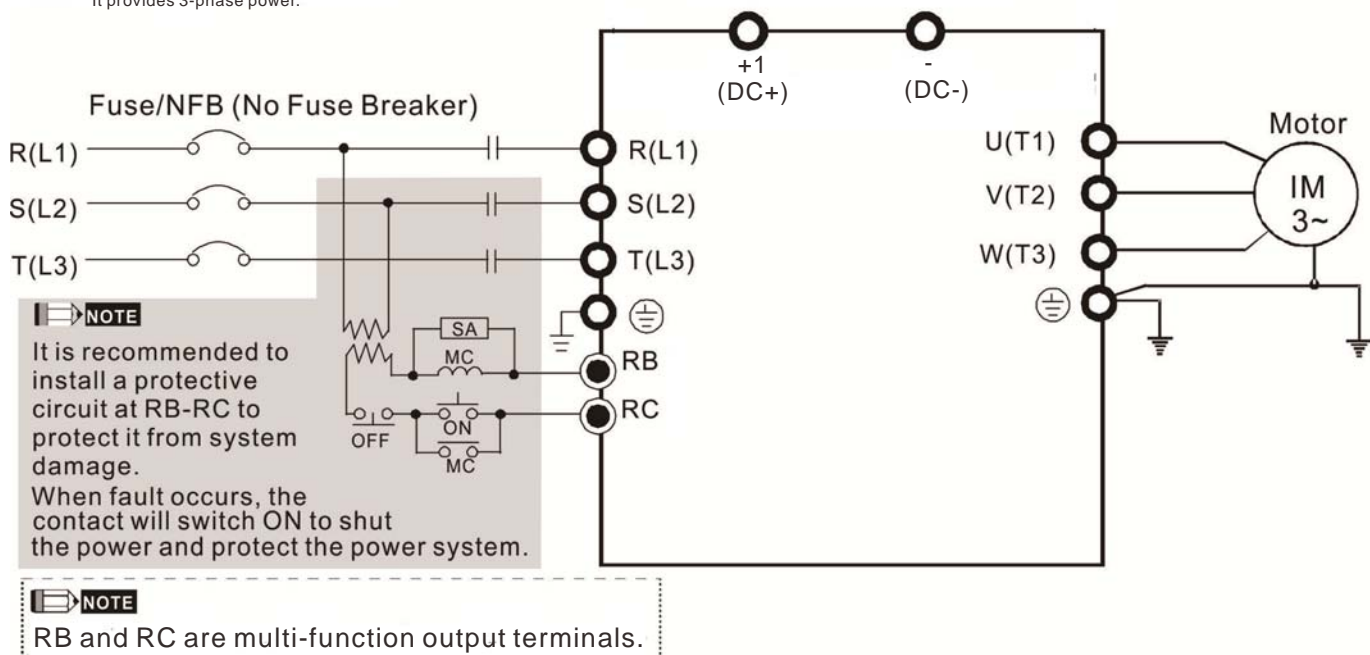

See page 3-5 for the wiring diagram of Emergency Power Supply (EPS).

Factory setting: NPN(SINK) Mode
Refer to figure 1 for wiring of NPN & PNP mode

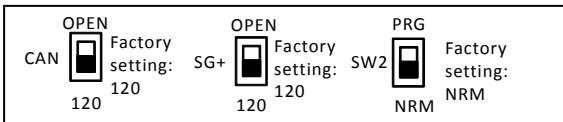
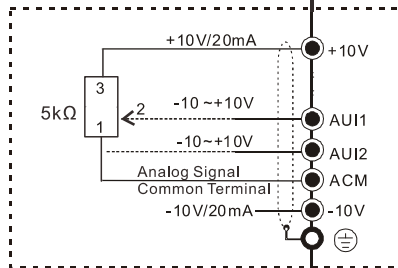
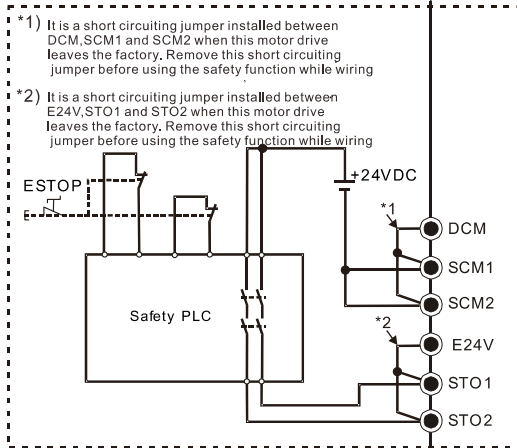
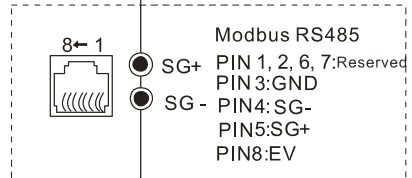
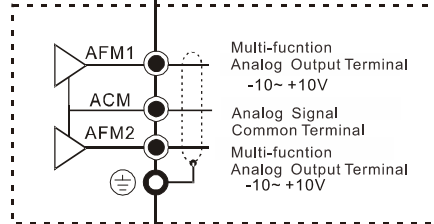
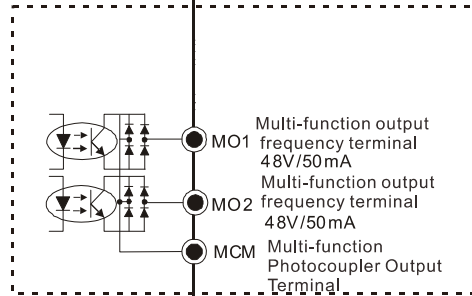
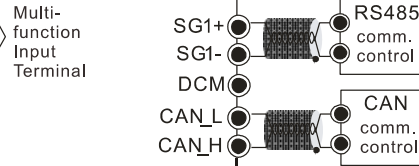
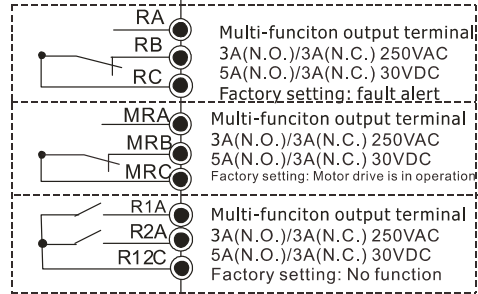
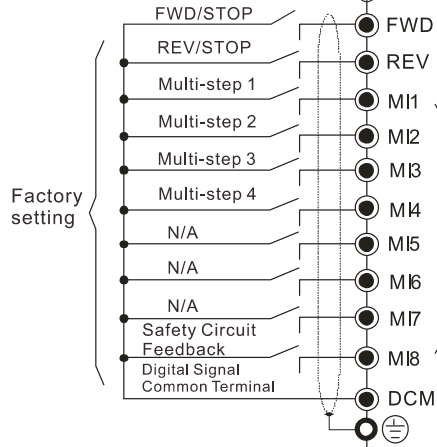

I/O card Expansion slot

PG card Expansion slot

Figure 1

Switching between two modes: SINK(NPN) /SOURCE(PNP)

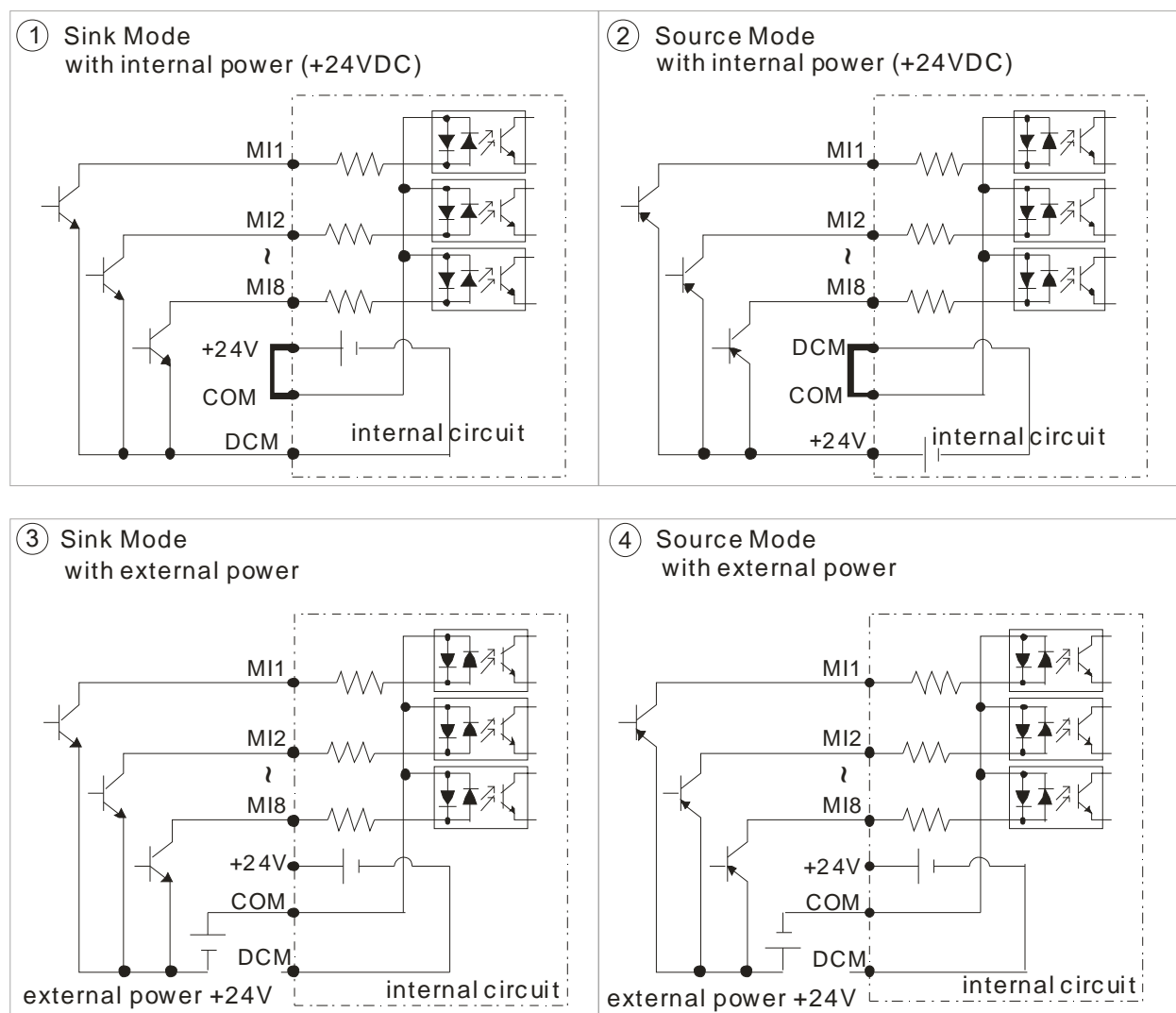
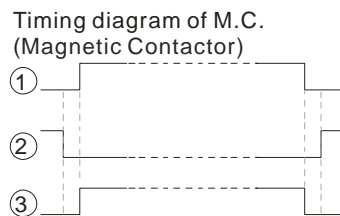
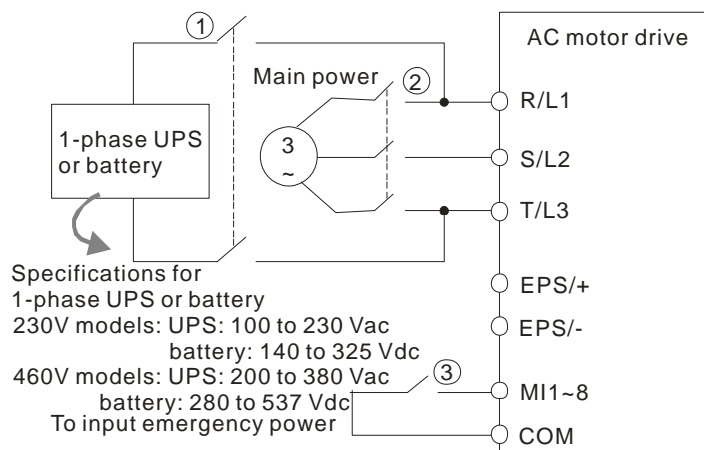

Figure 2. Emergency Power Supply (EPS) system wiring diagrams

For Frame B, C, D & E:

(1) Single phase UPS or battery can only be used on the main power supply



- Before using emergency power, close M.C. ①, M.C. ③ and keep, M.C. ② open.
- Close M.C. ① before you close M.C. ③.
- Before removing the battery, open M.C. ① and M.C. ③.
- Before you close M.C. ②, open M.C. ① and M.C. ③.

For Frame C & D:

(2) When the voltage of the main power supply is lower than 140Vdc(230V models) / 280Vdc (460V models), have the control power supply connected to a single phase UPS or a battery.

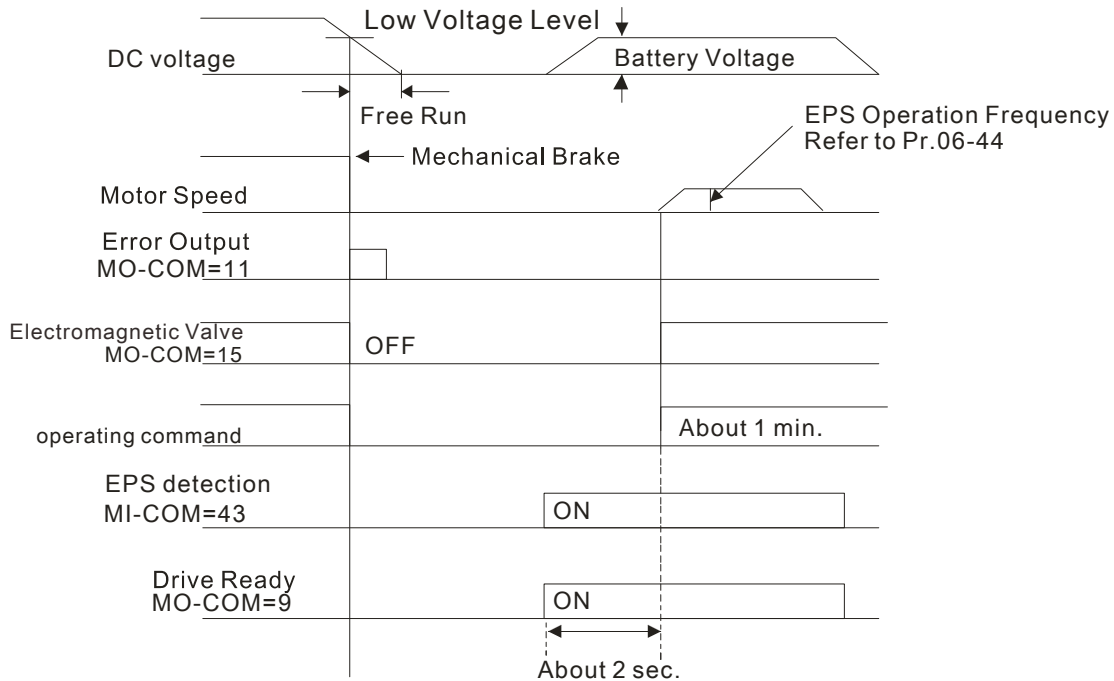
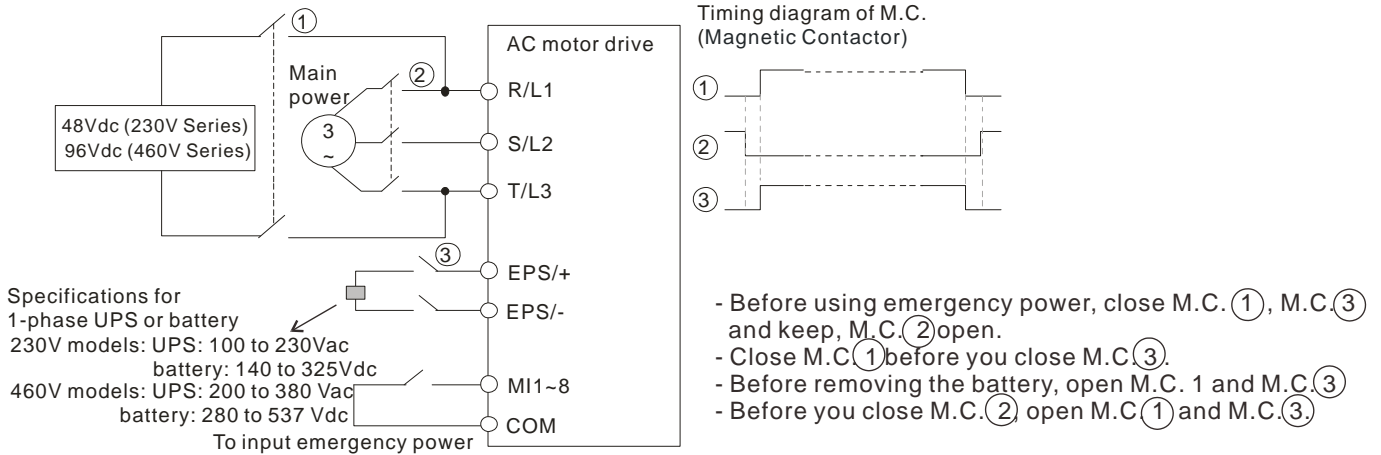

Notes about the emergency power supply (EPS).

Be aware of the following conditions when emergency power is ON:

1. Fan will not run to save energy from EPS.
2. Parameter setting will not be saved. When the power is turned off then applies again, the parameter setting will be gone.
3. Operate by the speed set at Pr.06-44.
4. Protections for low voltage and phase loss in NOT available.
5. Display DC-BUS voltage by Pr.06-29

3-2 System Wiring Diagram

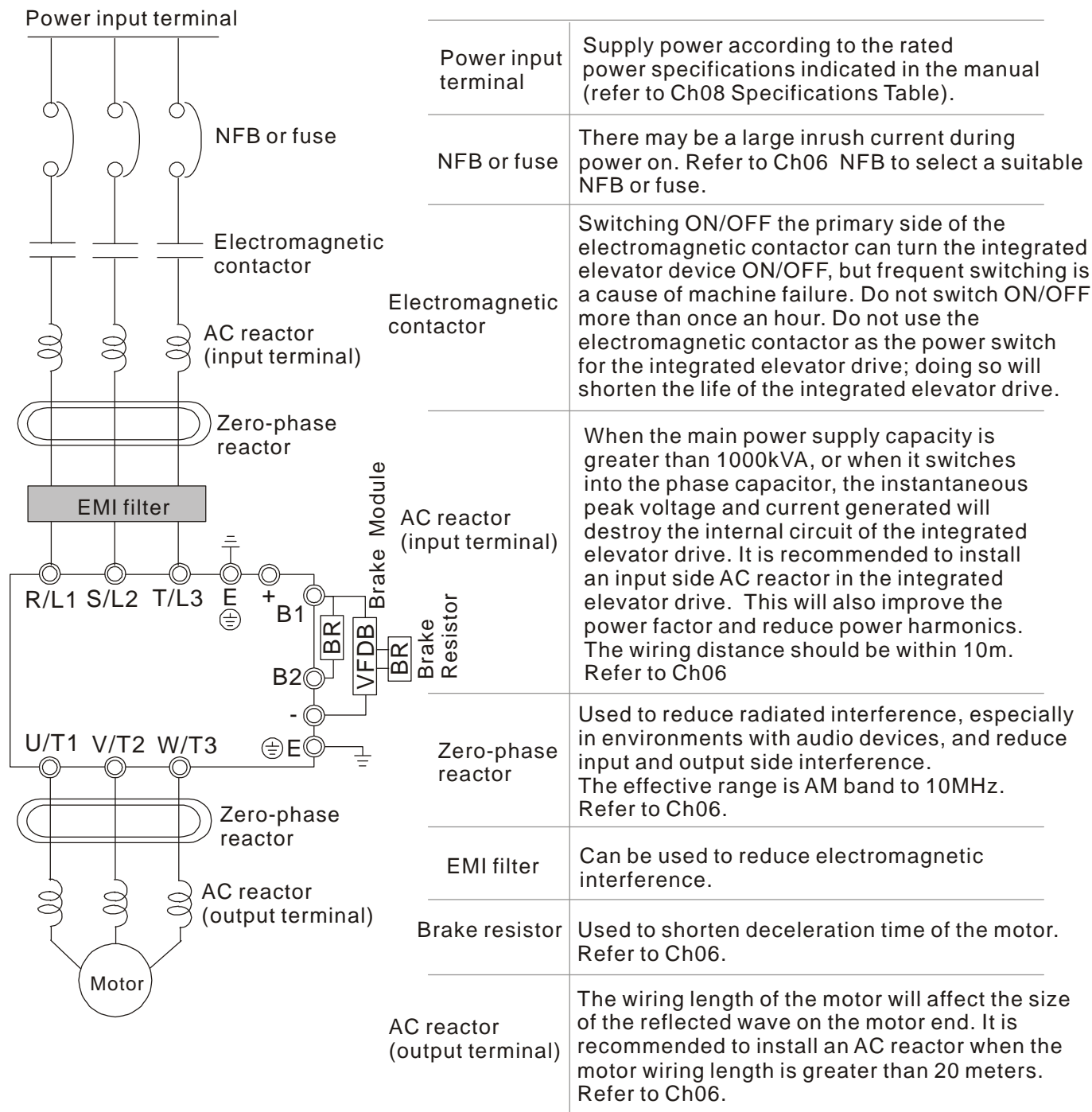

| | |
|------------------------------|---------------------------------------------------------------------------------------------------------------------------------------------------------------------------------------------------------------------------------------------------------------------------------------------------------------------------------------------------------------------------------------------------------------------------------------------------------|
| Power input terminal | Supply power according to the rated power specifications indicated in the manual (refer to Ch08 Specifications Table). |
| NFB or fuse | There may be a large inrush current during power on. Refer to Ch06 NFB to select a suitable NFB or fuse. |
| Electromagnetic contactor | Switching ON/OFF the primary side of the electromagnetic contactor can turn the integrated elevator device ON/OFF, but frequent switching is a cause of machine failure. Do not switch ON/OFF more than once an hour. Do not use the electromagnetic contactor as the power switch for the integrated elevator drive; doing so will shorten the life of the integrated elevator drive. |
| AC reactor (input terminal) | When the main power supply capacity is greater than 1000kVA, or when it switches into the phase capacitor, the instantaneous peak voltage and current generated will destroy the internal circuit of the integrated elevator drive. It is recommended to install an input side AC reactor in the integrated elevator drive. This will also improve the power factor and reduce power harmonics. The wiring distance should be within 10m. Refer to Ch06 |
| Zero-phase reactor | Used to reduce radiated interference, especially in environments with audio devices, and reduce input and output side interference. The effective range is AM band to 10MHz. Refer to Ch06. |
| EMI filter | Can be used to reduce electromagnetic interference. |
| Brake resistor | Used to shorten deceleration time of the motor. Refer to Ch06. |
| AC reactor (output terminal) | The wiring length of the motor will affect the size of the reflected wave on the motor end. It is recommended to install an AC reactor when the motor wiring length is greater than 20 meters. Refer to Ch06. |

04 Main Circuit Terminals

4-1 Main Circuit Diagram

Frame B

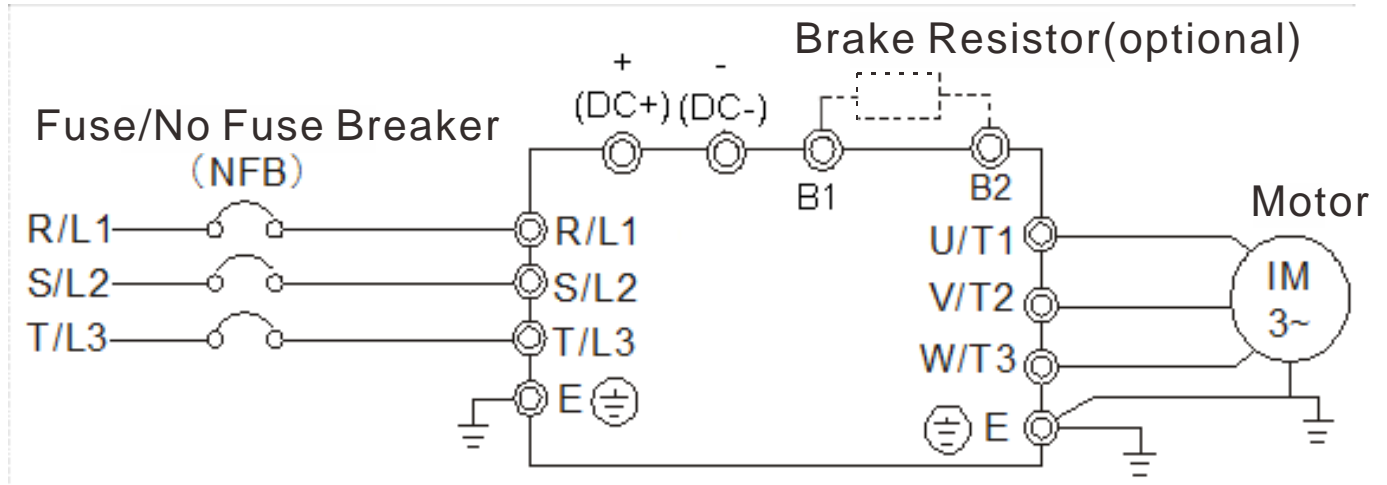

Frame C & D

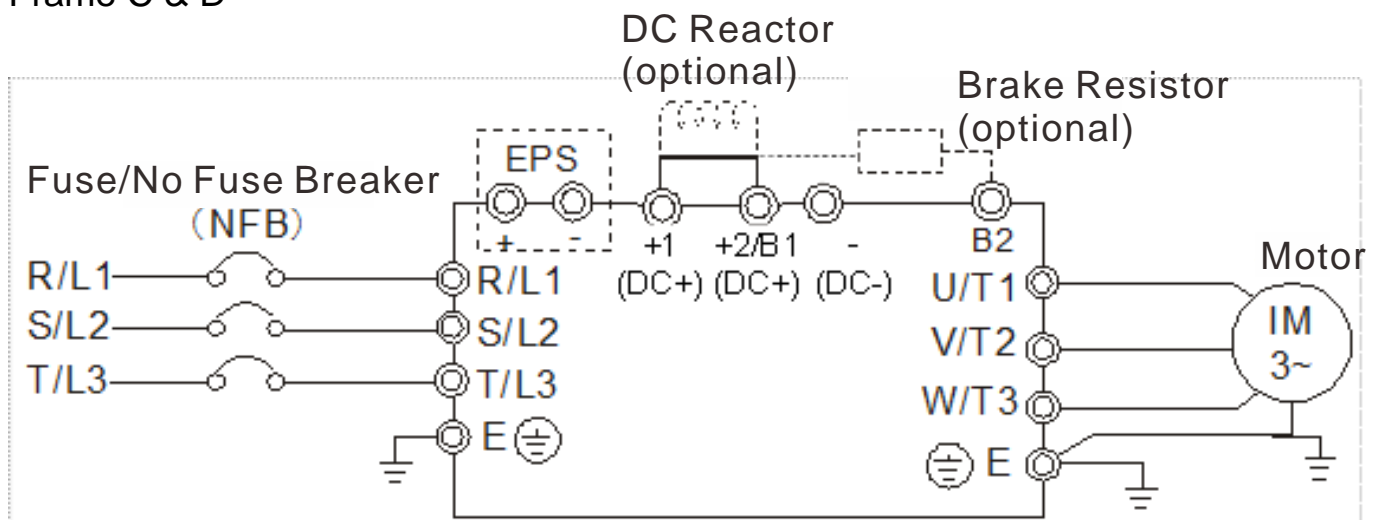

Frame E

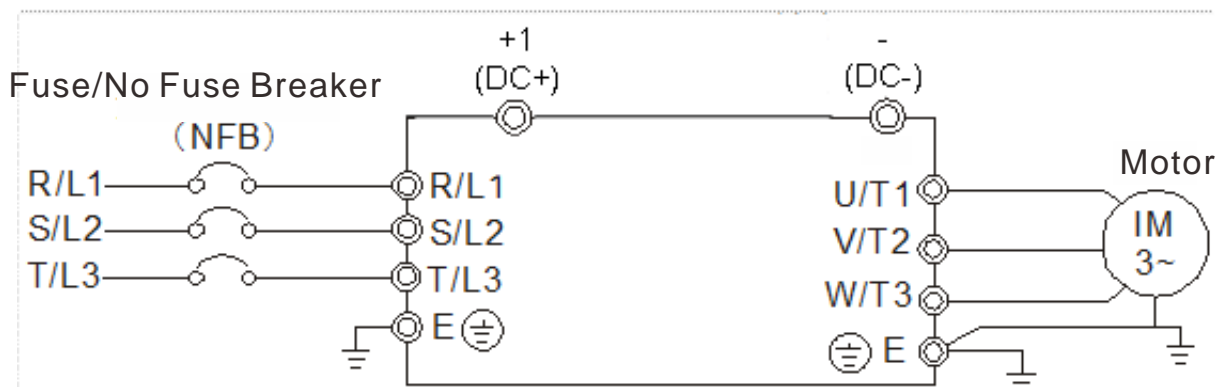

| Terminal Symbol | Explanation of Terminal Function |
|------------------|-------------------------------------------------------------------------------------------------------------------------------------------------|
| EPS (+, -) | Backup power/ Emergency power connection terminal. *1:EPS (Emergency Power Supply) input terminal supports only frame C & D. |
| R/L1, S/L2, T/L3 | AC line input terminals 3-phase. |
| U/T1, V/T2, W/T3 | AC drive output terminals for connecting 3-phase induction motor. |
| +1, +2/B1 | Connections for DC reactor to improve the power factor. Remove the jumper before installing a DC reactor. (Frame E has a DC reactor built-in.). |
| +2/B1, B2 | Connections for brake resistor (optional). |
| ⊕ E | Earth connection, to comply with local regulations. |



Main input power terminals:

- ☑ Do not connect 3-phase model to one-phase power. R/L1, S/L2 and T/L3 has no phase-sequence requirement, it can be used upon random selection.
- ☑ A NFB must be installed between the 3-phase power input terminals and the main circuit terminals (R/L1, S/L2, T/L3). It is recommended to add a magnetic contactor (MC) to the power input wiring to cut off power quickly and reduce malfunction when activating the protection function of the AC motor drive. Both ends of the MC should have an R-C surge absorber.
- ☑ Fasten the screws in the main circuit terminal to prevent sparks condition made by the loose screws due to vibration.
- ☑ Use voltage and current within the specification in Chapter 8.
- ☑ When using a general ELB (Earth Leakage Breaker), select a current sensor with sensitivity of 200mA or above and not less than 0.1-second operation time to avoid nuisance tripping. When choosing an ELB designed for the AC motor drive, choose a current sensor with sensitivity of 30mA or above.
- ☑ Use the shield wire or tube for the power wiring and ground the two ends of the shield wire or tube.
- ☑ Do NOT run/stop AC motor drives by turning the power ON/OFF. Run/stop AC motor drives by sending RUN/STOP command via control terminals or keypad. If you still need to run/stop AC motor drives by turning power ON/OFF, it is recommended to do so only ONCE per hour

Output terminals of the main circuit:

- ☑ When it is necessary to install a filter at the output side of terminals U/T1, V/T2, W/T3 on the AC motor drive. Use inductance filter. Do not use phase-compensation capacitors or L-C (Inductance-Capacitance) or R-C (Resistance-Capacitance).

- ☑ DO NOT connect phase-compensation capacitors or surge absorbers at the output terminals of AC motor drives.
- ☑ Use well-insulated motors to prevent any electric leakage from motors.

Terminals [+1, +2] for connecting DC reactor. Terminals [+1, +2/B1] for connecting brake resistor.

- ☑ These terminals are to connect to a DC reactor to improve the power factor and reduce harmonics. At the factory setting, a jumper is connected to these terminals. Remove that jumper before connecting to a DC reactor.

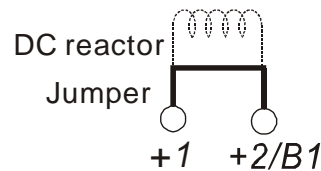

- ☑ Models above 22kW don't have a built-in brake resistor. To improve resistance ability, connect an external, optional brake resistor
- ☑ When not in use, leave terminals +2/B1, (–) open.
- ☑ Short-circuiting [B2] or [–] to [+2/B1] will damage the motor drive. Do NOT do that.

4-2 Main Circuit Terminals Specifications

Frame B

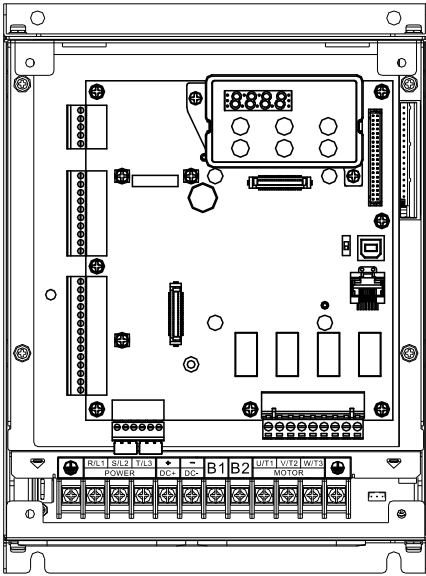

Main circuit terminals:

R/L1,S/L2, T/L3, U/T1, V/T2, W/T3,+(DC+),-(DC-),B1 ,B2 ↓

| Models | Wire Gauge | | Screw Size & Torque (±10%) |
|-------------|---------------------------------|---------------------------------|----------------------------------------------|
| | Max. Wire Gauge | Min. Wire Gauge | |
| VFD022ED21S | 10AWG [5.3mm ²] | 14AWG [2.1mm ²] | M4 18 kgf-cm (15.6 lbf-in) (1.7 Nm) |
| VFD040ED43S | | 12AWG [3.3mm ²] | |
| VFD037ED21S | | | |
| VFD040ED23S | | | |

UL installations must use 600V, 75 °C wire. Use copper wire only.

NOTE:

- Figure 1 shows the terminal specification.
- Figure 2 shows the specification of insulated heat shrink tubing that comply with UL (600V, YDPU2).

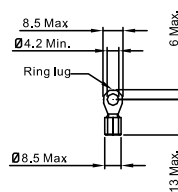

Figure 1

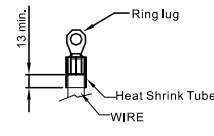
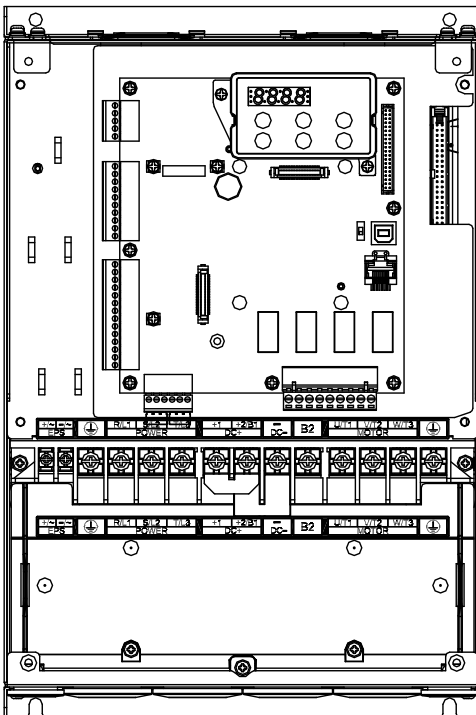

Figure 2

Frame C



Main circuit terminals:

R/L1,S/L2,T/L3,U/T1,V/T2, W/T3,+1,+2/B1,-,B2, ↓

| Models | Wire Gauge | | Screw Size & Torque (±10%) |
|-------------|---------------------------------|---------------------------------|--------------------------------------------|
| | Max. Wire Gauge | Min. Wire Gauge | |
| VFD055ED23S | 6AWG [13.3mm ²] | 10AWG [3.3mm ²] | M5 30 kgf-cm (26 lbf-in) (2.9 Nm) |
| VFD110ED43S | | 12AWG [3.3mm ²] | |
| VFD055ED43S | | | |
| VFD075ED43S | | | |
| VFD075ED23S | | | |
| VFD150ED43S | | | |
| VFD185ED43S | | | |
| VFD110ED23S | | | |

UL installations must use 600V, 75 °C wire. Use copper wire only.

NOTE:

- Figure 1 shows the terminal specification.
- Figure 2 shows the specification of insulated heat shrink tubing that comply with UL (600V, YDPU2).

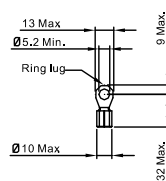

Figure 1

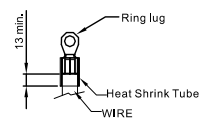
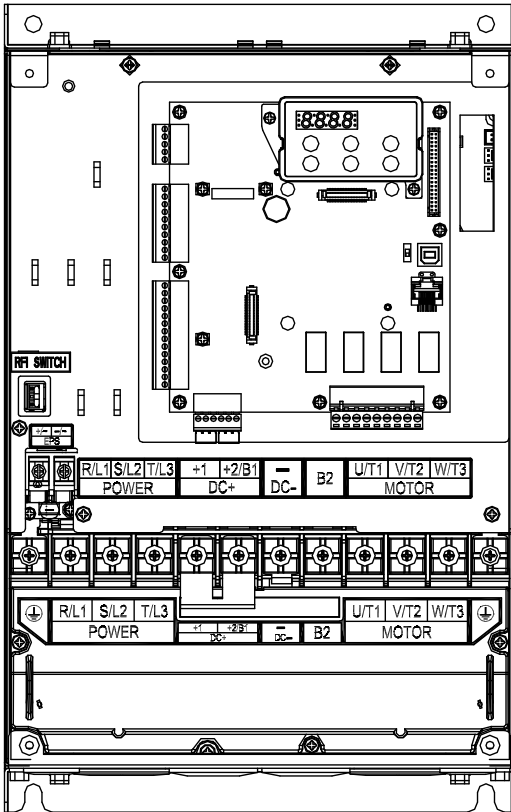

Figure 2

Frame D



Main circuit terminals:

R/L1, S/L2, T/L3, U/T1, V/T2, W/T3, +1, +2/B1, -, B2, ↓

| Models | Wire Gauge | | Screw Size & Torque (±10%) |
|-------------|---------------------------------|---------------------------------|----------------------------------------------|
| | Max. Wire Gauge | Min. Wire Gauge | |
| VFD150ED23S | 2AWG [33.6mm ²] | 4AWG [21.1mm ²] | M6 50 kgf-cm (43.4 lbf-in) (4.9 Nm) |
| VFD300ED43S | | 3AWG[26.7mm ²] | |
| VFD185ED23S | | 6AWG[13.3mm ²] | |
| VFD220ED43S | | | |
| VFD220ED23S | | 2AWG[33.6mm ²] | |

UL installations must use 600V, 75 °C wire. Use copper wire only.

NOTE:

- Figure 1 shows the terminal specification.
- Figure 2 shows the specification of insulated heat shrink tubing that comply with UL (600V, YDPU2).

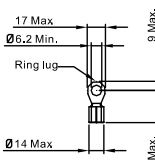

Figure 1

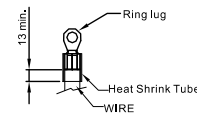
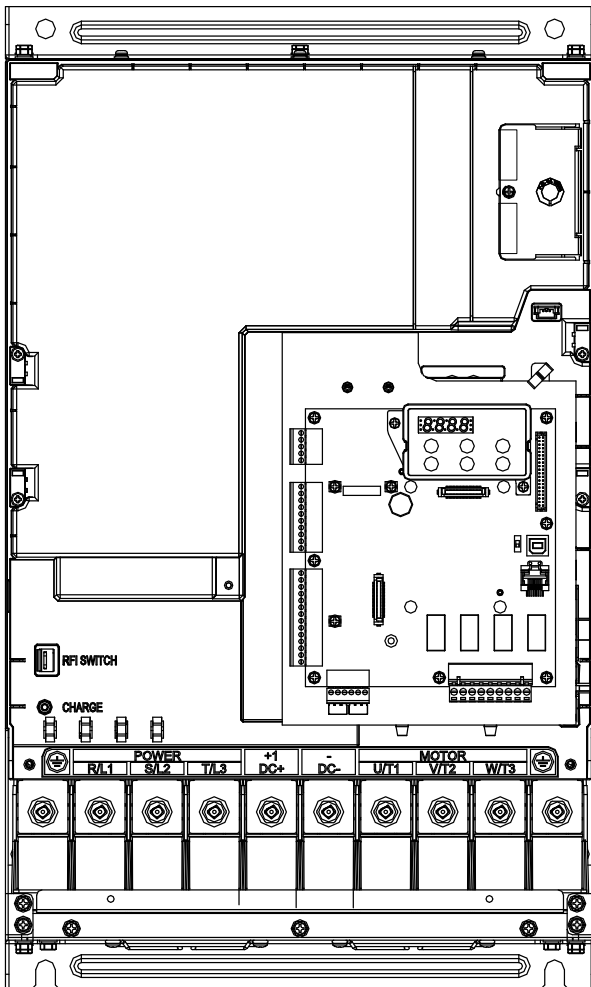

Figure 2

Frame E



Main circuit terminals:

R/L1, S/L2, T/L3, U/T1, V/T2, W/T3, +1(DC+), -(DC-), ↓

| Models | Wire Gauge | | Screw Size & Torque (±10%) |
|-------------|----------------------------------|----------------------------------|-----------------------------------------------|
| | Max. Wire Gauge | Min. Wire Gauge | |
| VFD370ED43S | 300MCM [152mm ²] | 1/0AWG[53.5mm ²] | M8 200 kgf-cm (173 lbf-in) (19.6 Nm) |
| VFD450ED43S | | 2/0AWG[67.4mm ²] | |
| VFD300ED23S | | 4/0AWG [107mm ²] | |
| VFD550ED43S | | | |
| VFD370ED23S | | 300MCM [152mm ²] | |

UL installations must use 600V, 75 °C wire. Use copper wire only.

NOTE:

- Figure 1 shows the terminal specification.
- Figure 2 shows the specification of insulated heat shrink tubing that comply with UL (600V, YDPU2).

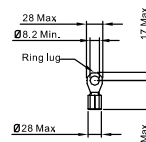

Figure 1

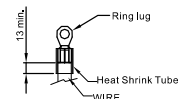

Figure 2

05 Control Terminals

Remove the top cover before wiring the multi-function input and output terminals

The motor drives' figures shown below are for reference only; the real motor drives may look different.

Remove the cover before wiring

Frame B, C & D:

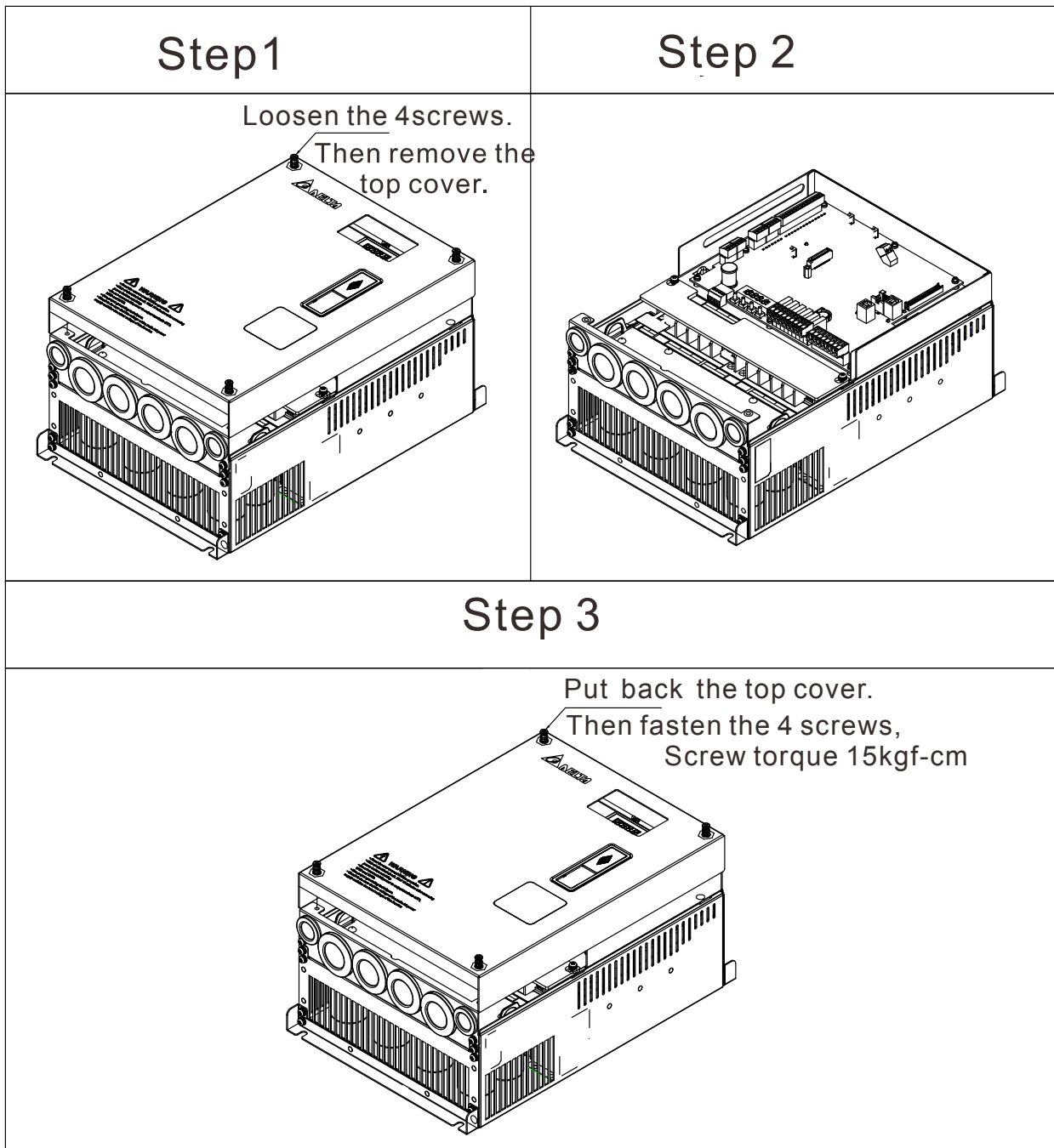

Frame E

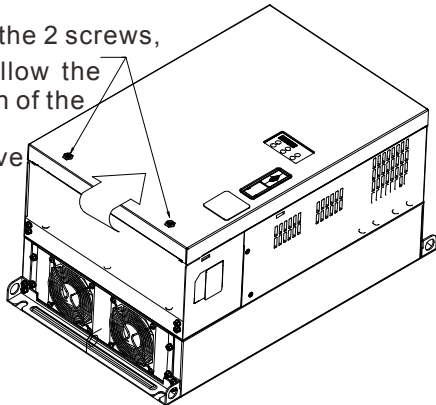
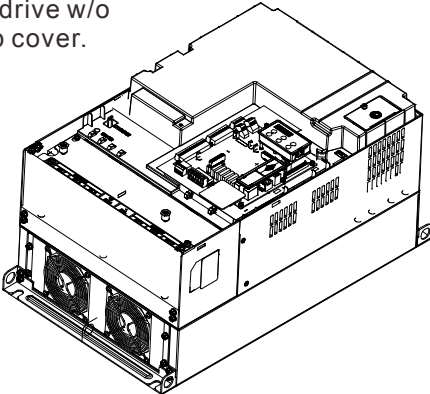
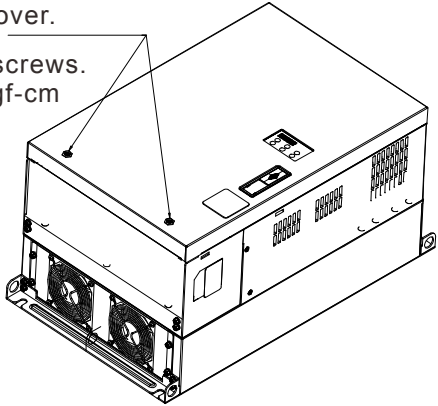
| Step 1 | Step 2 |
|----------------------------------------------------------------------------------------------------------------------------------------------------------------------------------------------------------------------------------|-----------------------------------------------------------------------------------------------------------------------------------------------------------|
| <p data-bbox="268 280 534 481">Loosen the 2 screws, Then follow the direction of the arrow to remove the top cover</p>  | <p data-bbox="865 257 1061 324">Motor drive w/o the top cover.</p>  |
| Step 3 | |
| <p data-bbox="422 772 742 884">Put back the top cover. Then fasten the 2 screws. Screw torque: 15kgf-cm</p>  | |

Specifications of the Control Terminal

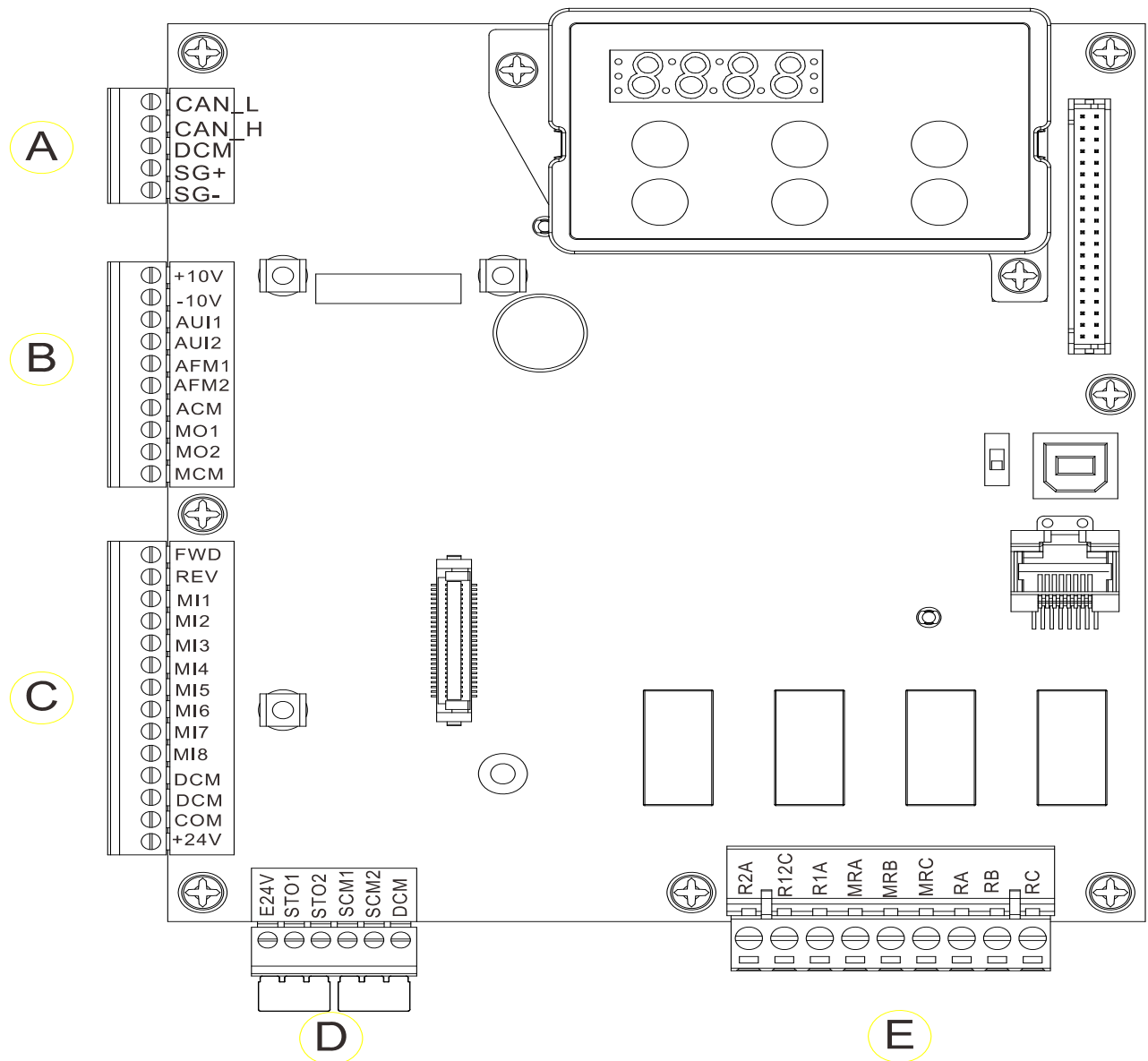

Control Circuit Terminal Sockets:

Terminal sockets A, B, C

Torque force: 2kg-cm [1.7lb-in.] (0.20Nm)

Wire gauge: 28~14AWG [0.08~2.07mm²]

Terminal socket D:

Torque force: 2kg-cm [1.7lb-in.] (0.20Nm)

Terminal socket E:

Torque force: 5.2kg-cm [4.5lb-in.] (0.51Nm)

Wire gauge: 28~12AWG [0.08~3.33mm²]

To comply with UL standards, copper wires which are able to sustain 600V, 75 ° C environments must be used in the installation.

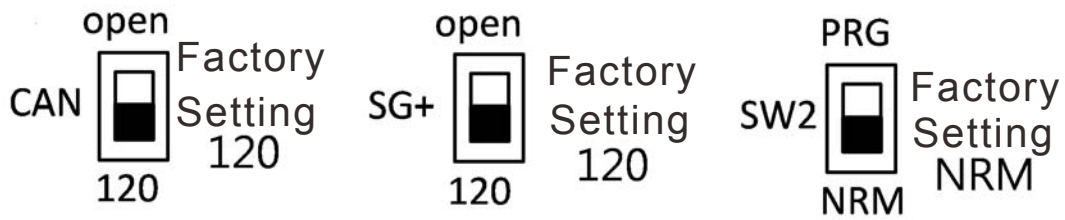

Control Board Switch

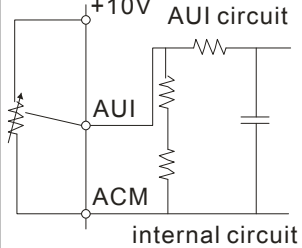

NRM = Normal

| Terminals | Terminal Function | Factory Setting (NPN mode) |
|-----------------|------------------------------------------------------------------------------------------------------------------------------------------------------------------------------------------------------------------------------------------------------------|---------------------------------------------------------------------------------------------------------------------------------------------------------------------------------------------------------------------------|
| +24V/E24V | Digital control signal common terminal (Source) | +24V±5% 200mA |
| COM | Digital control signal common terminal (Sink) | Common terminal of multi-function input terminals |
| FWD | Forward-Stop command | FWD-DCM: ON= forward running OFF= deceleration to stop |
| REV | Reverse-Stop command | REV-DCM: ON= forward running OFF= deceleration to stop |
| MI1 ~ MI8 | Multi-function input 1~8 | Refer to parameters 02-01~02-08 to program the multi-function inputs MI1~MI8. Source mode: ON: the activation current is $6.5\text{mA} \geq 11\text{Vdc}$ OFF: cut-off voltage $10\mu\text{A} \leq 11\text{Vdc}$ |
| DCM | Digital frequency signal common terminal | |
| SCM1 | The factory setting is short-circuiting. The factory setting is short-circuiting. Power removal safety function for EN954-1 and IEC/EN61508 When STO1~SCM1, STO2~SCM2 are turned on, the activation current is $3.3\text{mA} \geq 11\text{Vdc}$. | |
| SCM2 | | |
| STO1 | | |
| STO2 | | |
| +10V | Potentiometer power supply | Power supply of analog frequency setting: +10Vdc 20mA |
| -10V | Potentiometer power supply | Power supply of analog frequency setting |
| AUI1 | Analog voltage frequency input  AUI circuit internal circuit | Impedance: 20kΩ Range: -10~+10VDC=0~ Max. Output Frequency(Pr.01-00) |
| AUI2 | | |

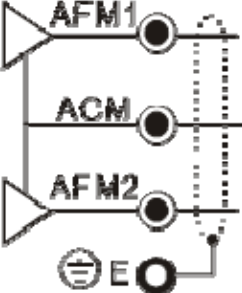
| | | |
|-------|--------------------------------------------------------------------------|----------------------------------------------------------------------------------------------------------------------------------------------------------------------------------------------------------------------------------------------------------------------|
| ACM | Analog signal common terminal control | Analog signal terminal |
| RA | Multi-function relay output A (N.O.) | <p>1. User-defined function 2. Resistive Load 3A(N.O.)/3A(N.C.) 250VAC 5A(N.O.)/3A(N.C.) 30VDC (min. 5 VDC, 10 mA) To output different kinds of signal such as the motor drive is in operation, reaching the frequency, overload indication.</p> |
| RB | Multi-function relay output A (N.C.) | |
| RC | Multi-function relay output B (Error indication by factory setting) | |
| MRA | Multi-function output terminal (N.O.) | |
| MRB | Multi-function output terminal (N.C.) | |
| MRC | Multi-function output terminal (Operating Indication by factory setting) | |
| R1A | Multi-function output terminal A (N.O.) | |
| R2A | Multi-function output terminal A (N.O.) | |
| R12C | Multi-function output terminal (No function by factory setting) | |
| SG1+ | Modbus RS-485 | |
| SG1- | Modbus RS-485 | |
| CAN_L | CAN Bus | DIP Switch: terminator 120 ohm (factory setting)/ open |
| CAN_H | CAN Bus | |
| MO1 | Multi-function output terminal 1 (photocoupler) | <p>The AC motor drive releases various monitoring signals, such as drive in operation, reaching frequency and overload indication via a transistor (open collector).</p>  |
| MO2 | Multi-function output terminal 2 (photocoupler) | |
| MCM | Multi-function output common terminal (photocoupler) | Max 48Vdc 50mA |

| | | |
|-------|--------------------------------------------------------------------------------------------------|-------------------------------------------------------------------------------------------------------------------------------------------------------------------------------------------------------------------------------------------|
| AFM1 |  | <p>0~10V, Max. output current: 2mA, Max. load: 5kΩ -10~10V, Max. output current: 2mA, Max. load :5kΩ Output current 2mA max Resolution 0~10V corresponds to the Max. operating frequency. Range: 0~10V→-10~+10V</p> |
| AFM2 |  | <p>0~10V, Max. Output current: 2mA, Max. load: 5KΩ -10~10V, Max. output current: 2mA, Max. load: 5kΩ Output current: 2mA max Resolution: 0~10V corresponds to the Max. operating frequency. Range: 0~10V→-10~+10V</p> |
| RJ-45 | PIN 1,2,6,7 : Reserved PIN 3: SGND PIN 4: SG- PIN 5: SG+ PIN 8: EV | |
| SW2 | Switching USB port | DIP Switch: NRM (factory setting) / PRG (this side of the switch is to update firmware and is intended for qualified motor drive service personnel only. Do NOT try to update by yourself. |

06 Optional Accessories

The optional accessories listed in this chapter are available upon request. Installing additional accessories to your drive would substantially improve the drive's performance. Please select an applicable accessory according to your need or contact the local distributor for suggestion.

6-1 Brake Resistors & Brake Units used in AC motor Drives

| Voltage | Applicable Motor | 125% Braking Torque /30% ED * ¹ | | | | | | | | Max. Brake Torque * ² | | |
|---------|------------------|--------------------------------------------|--------------------|----------|----------------------------------------------|----------------------------------|----------|------------------------|---------------------|----------------------------------|-------------------------------|-----------------|
| | Model | Braking Torque * ³ (kg-m) | Brake Unit | | Resistor value spec. for each AC motor Drive | Braking Resistor series for each | | | Braking Current (A) | | | |
| | | | VFDB* ⁵ | Quantity | | Brake Unit | | | | | | |
| | | | | | | model #* ⁴ | Quantity | Wiring Method | | Min. Resistor Value(Ω) | Max. Total Braking Current(A) | Peak Power (kW) |
| 230V | VFD022ED21S | 1.5 | | | 1000W 75Ω | BR1K0W075 | 1 | | 5.1 | 38.0 | 10 | 3.8 |
| | VFD037ED21S | 2.5 | | | 2000W 37.5Ω | BR1K0W075 | 2 | 2 parallel | 10.1 | 19.0 | 20 | 7.6 |
| | VFD040ED23S | 2.5 | | | 2000W 37.5Ω | BR1K0W075 | 2 | 2 parallel | 10.1 | 19.0 | 20 | 7.6 |
| | VFD055ED23S | 3.7 | | | 3000W 25Ω | BR1K0W075 | 3 | 3 parallel | 15.2 | 15.6 | 24.4 | 9.3 |
| | VFD075ED23S | 5.1 | | | 3000W 25Ω | BR1K0W075 | 3 | 3 parallel | 15.2 | 11.5 | 33 | 12.5 |
| | VFD110ED23S | 7.5 | | | 5000W 15Ω | BR1K0W075 | 5 | 5 parallel | 25.3 | 9.5 | 40 | 15.2 |
| | VFD150ED23S | 10.2 | | | 6000W 13Ω | BR1K5W013 | 4 | 2 serial 2 parallel | 29.2 | 8.3 | 46 | 17.5 |
| | VFD185ED23S | 12.2 | | | 8000W 9.4Ω | BR1K0W075 | 8 | 8 parallel | 38.0 | 5.8 | 66 | 25.1 |
| | VFD220ED23S | 14.9 | | | 8000W 9.4Ω | BR1K0W075 | 8 | 8 parallel | 40.5 | 5.8 | 66 | 25.1 |
| | VFD300ED23S | 20.3 | 2015 | 2 | 9000W 6.5Ω | BR1K5W013 | 8 | 2 serial 4 parallel | 58.5 | 4.8 | 80 | 30.4 |
| | VFD370ED23S | 25.1 | 2022 | 2 | 14000W 5.4Ω | BR1K0W075 | 14 | 14 parallel | 70.9 | 3.2 | 120 | 45.6 |
| 460V | VFD040ED43S | 2.7 | | | 1500W 280Ω | BR750W140 | 2 | 2 serial | 2.7 | 54.3 | 14 | 10.6 |
| | VFD055ED43S | 3.7 | | | 2000W 150Ω | BR1K0W075 | 2 | 2 serial | 5.1 | 48.4 | 15.7 | 11.9 |
| | VFD075ED43S | 5.1 | | | 4000W 75Ω | BR1K0W075 | 4 | 2 serial 2 parallel | 10.1 | 48.4 | 15.7 | 11.9 |
| | VFD110ED43S | 7.5 | | | 4000W 75Ω | BR1K0W075 | 4 | 2 serial 2 parallel | 10.1 | 30.8 | 24.7 | 18.8 |
| | VFD150ED43S | 10.1 | | | 6000W 50Ω | BR1K0W075 | 6 | 2serial 3 parallel | 15.2 | 25.0 | 30.4 | 23.1 |
| | VFD185ED43S | 12.5 | | | 8000W 37.5Ω | BR1K0W075 | 8 | 2 serial 4 parallel | 20.3 | 20.8 | 36.5 | 27.7 |
| | VFD220ED43S | 14.9 | | | 8000W 37.5Ω | BR1K0W075 | 8 | 2 serial 4 parallel | 20.3 | 19.0 | 40 | 30.4 |
| | VFD300ED43S | 20.3 | | | 12000W 26Ω | BR1K5W043 | 8 | 4 serial 2 parallel | 29.2 | 14.1 | 54 | 41.0 |
| | VFD370ED43S | 25.0 | 4045 | 1 | 14000W 21.4Ω | BR1K1W024 | 14 | 2 serial 7 parallel | 35.5 | 12.7 | 60 | 45.6 |

| | | | | | | | | | | | |
|-------------|------|------|---|--------------|-----------|----|----------------------|------|------|-----|------|
| VFD450ED43S | 30.4 | 4045 | 1 | 16000W 18.8Ω | BR1K0W016 | 16 | 2 serial 8 parallel | 40.5 | 12.7 | 60 | 45.6 |
| VFD550ED43S | 37.2 | 4030 | 2 | 20000W 15Ω | BR1K0W016 | 20 | 2 serial 10 parallel | 50.7 | 9.5 | 80 | 60.8 |
| VFD750ED43S | 50.7 | 4045 | 2 | 28000W 10.7Ω | BR1K0W016 | 28 | 2serial 14 parallel | 70.9 | 6.3 | 120 | 91.2 |

*1 Calculation of 125% brake torque: $(kW) \times 125\% \times 0.8$; where 0.8 is the motor efficiency.

Since there is a resistor limit of power consumption, the longest operation time for 30%ED is 30 sec (On: 30sec/ Off: 70sec).

*2 Refer to the Brake Performance Curve for “Operation Duration & ED” vs. “Braking Current”.

*3 The calculation of the braking torque I s based on a 4-pole motor (1800 rpm).

*4 To dissipate heat, a resistor of 400W or lower should be fixed to the frame and maintain the surface temperature below 250°C (482 °F); a resistor of 1000W and above should maintain the surface temperature below 600°C (1112 °F). If the surface temperature is higher than the temperature limit, install more heat dissipating system or increase the size of the resistor.

*5 Refer to VFDB series Braking Module Instruction for more detail on braking resistor.

NOTE

1. Select the recommended resistance value (Watt) and the duty-cycle value (ED %).

Definition for Brake Usage ED%

Explanation: The definition of the brake usage ED (%) is for assurance of enough time for the brake unit and brake resistor to dissipate away heat generated by braking. When the brake resistor heats up, the resistance would increase with temperature, and brake torque would decrease accordingly. Recommended cycle time is one minute.

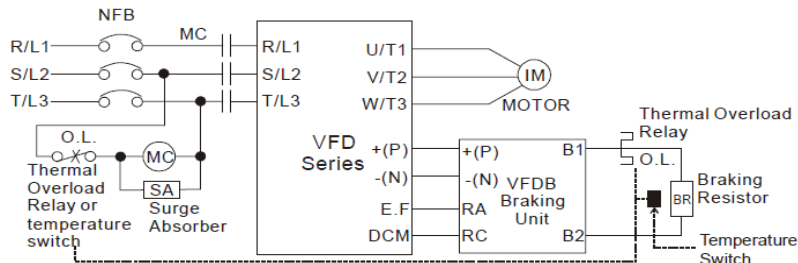
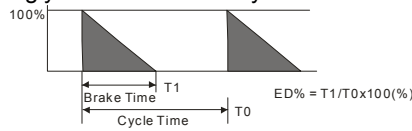

Note1: When using the AC drive with DC reactor, please refer to wiring diagram in the AC drive user manual for the wiring of terminal + (P) of Braking unit.
 Note2: Do NOT wire terminal - (N) to the neutral point of power system.

For safety consideration, install an overload relay between the brake unit and the brake resistor. In conjunction with the magnetic contactor (MC) prior to the drive, it can perform complete protection against abnormality. The purpose of installing the thermal overload relay is to protect the brake resistor from damage due to frequent brake, or due to brake unit keeping operating resulted from unusual high input voltage. Under such circumstance, just turn off the power to prevent damaging the brake resistor.

2. If damage to the drive or other equipment is due to the fact that the brake resistors and the brake modules in use are not provided by Delta, the warranty will be void.
3. Take into consideration the safety of the environment when installing the brake resistors. If the minimum resistance value is to be utilized, consult local dealers for the calculation of the Watt figures.
4. When using more than 2 brake units, equivalent resistor value of parallel brake unit can't be less than the value in the column “Minimum Equivalent Resistor Value for Each AC Drive” (the right-most column in the table).
5. This chart is for normal usage; if the AC motor drive is applied for frequent braking, it is suggested to enlarge 2~3 times of the Watts.
6. Thermal relay selection:

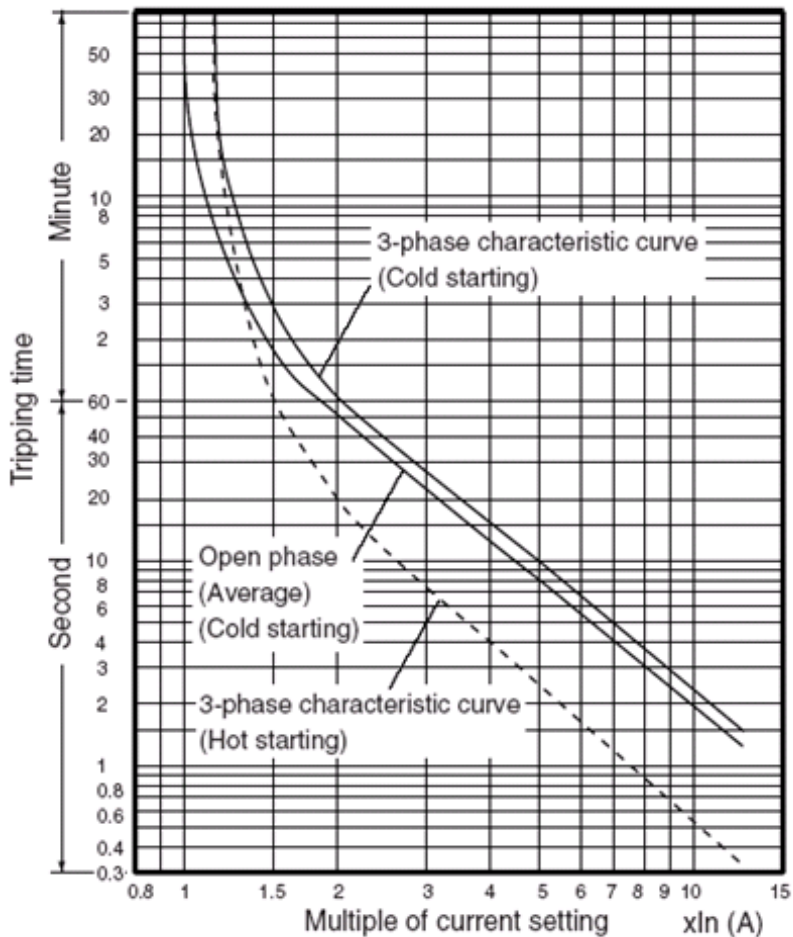

Thermal Relay:

Thermal relay selection is based on its overload capability. A standard braking capacity of ED is 10%ED (Tripping time=10s). The figure on the left is an example of 460V, 110kw AC motor drive. It requires the thermal relay to take 260% overload capacity for 10sec (hot starting) and the braking current is 126A. In this case, user should select a rated 50A thermal relay. The property of each thermal relay may vary among different manufacturers. Read carefully the user guide of a thermal relay before using it. .

6-2 Non-fuse Circuit Breaker

Comply with UL standard: Per UL 508, paragraph 45.8.4, part a. The rated current of a breaker shall be 2~4 times of the maximum rated input current of AC motor drive.

| 3-phase | | 3-phase | |
|-------------|---------------------------------|-------------|---------------------------------|
| Model | Recommended non-fuse breaker(A) | Model | Recommended non-fuse breaker(A) |
| VFD022ED21S | 50 | VFD040ED43S | 30 |
| VFD037ED21S | 75 | VFD055ED43S | 35 |
| VFD040ED23S | 40 | VFD075ED43S | 40 |
| VFD055ED23S | 50 | VFD110ED43S | 50 |
| VFD075ED23S | 60 | VFD150ED43S | 60 |
| VFD110ED23S | 100 | VFD185ED43S | 75 |
| VFD150ED23S | 125 | VFD220ED43S | 100 |
| VFD185ED23S | 150 | VFD300ED43S | 125 |
| VFD220ED23S | 175 | VFD370ED43S | 150 |
| VFD300ED23S | 250 | VFD450ED43S | 200 |
| VFD370ED23S | 300 | VFD550ED43S | 250 |
| | | VFD750ED43S | 350 |

6-3 Fuse Specification Chart

- Use only the fuses comply with UL certificated.
- Use only the fuses comply with local regulations.

| Model | Input Current (A) | Line Fuse | |
|-------------|-------------------|-----------|--------------|
| | | I (A) | Bussmann P/N |
| VFD022ED21S | 26 | 60 | JJN-60 |
| VFD037ED21S | 37 | 90 | JJN-90 |
| VFD040ED23S | 20 | 50 | JJN-50 |
| VFD055ED23S | 23 | 60 | JJN-60 |
| VFD075ED23S | 30 | 80 | JJN-80 |
| VFD110ED23S | 47 | 125 | JJN-125 |
| VFD150ED23S | 56 | 150 | JJN-150 |
| VFD185ED23S | 73 | 175 | JJN-175 |
| VFD220ED23S | 90 | 225 | JJN-225 |
| VFD300ED23S | 132 | 300 | JJN-300 |
| VFD370ED23S | 161 | 400 | JJN-400 |
| VFD040ED43S | 11.5 | 35 | JJS-35 |
| VFD055ED43S | 14 | 40 | JJS-40 |
| VFD075ED43S | 17 | 45 | JJS-45 |
| VFD110ED43S | 24 | 60 | JJS-60 |
| VFD150ED43S | 30 | 80 | JJS-80 |
| VFD185ED43S | 37 | 90 | JJS-90 |
| VFD220ED43S | 47 | 110 | JJS-110 |
| VFD300ED43S | 58 | 150 | JJS-150 |
| VFD370ED43S | 80 | 200 | JJS-200 |
| VFD450ED43S | 100 | 250 | JJS-250 |
| VFD550ED43S | 128 | 300 | JJS-300 |
| VFD750ED43S | 165 | 400 | JJS-400 |

6-4 AC/ DC Reactor

AC Input/ Output Reactor

200V~230V/ 50~60Hz (Single Phase Power)

| Type | KW | HP | Rated Amps (Arms) | Max. Continuous Amps (Arms) | 3% impedance (mH) | 5% impedance (mH) | Built-in DC Reactor | 3% Input AC reactor Delta Part# |
|------|-----|----|-------------------|-----------------------------|-------------------|-------------------|---------------------|---------------------------------|
| 022 | 2.2 | 3 | 12 | 24 | 0.919 | 1.531 | X | N/A |
| 037 | 3.7 | 5 | 17 | 34 | 0.649 | 1.081 | X | N/A |

200V~230V/ 50~60Hz (Three-phase power)

| Type | KW | HP | Rated Amps (Arms) | Max. Continuous Amps (Arms) | 3% impedance (mH) | 5% impedance (mH) | Built-in DC Reactor | 3% Input AC reactor Delta Part# |
|------|------|-----|-------------------|-----------------------------|-------------------|-------------------|---------------------|---------------------------------|
| 040 | 4 | 5 | 20 | 40 | 0.551 | 0.919 | X | N/A |
| 055 | 5.5 | 7.5 | 24 | 48 | 0.459 | 0.766 | X | N/A |
| 075 | 7.5 | 10 | 30 | 60 | 0.320 | 0.534 | X | N/A |
| 110 | 11 | 15 | 45 | 90 | 0.216 | 0.359 | X | N/A |
| 150 | 15 | 20 | 58 | 116 | 0.163 | 0.271 | X | N/A |
| 185 | 18.5 | 25 | 77 | 154 | 0.143 | 0.239 | X | N/A |
| 220 | 22 | 30 | 87 | 174 | 0.127 | 0.211 | X | N/A |
| 300 | 30 | 40 | 132 | 264 | 0.084 | 0.139 | O | N/A |
| 370 | 37 | 50 | 161 | 322 | 0.068 | 0.114 | O | N/A |

380V~460V/ 50~60Hz (Three-phase power)

| Type | KW | HP | Rated Amps (Arms) | Max. Continuous Amps (Arms) | 3% impedance (mH) | 5% impedance (mH) | Built-in DC Reactor | 3% Input AC reactor Delta Part# |
|------|------|-----|-------------------|-----------------------------|-------------------|-------------------|---------------------|---------------------------------|
| 040 | 4 | 5 | 11.5 | 23 | 1.838 | 3.063 | X | N/A |
| 055 | 5.5 | 7.5 | 13 | 26 | 1.626 | 2.710 | X | N/A |
| 075 | 7.5 | 10 | 17 | 34 | 1.243 | 2.072 | X | N/A |
| 110 | 11 | 15 | 23 | 46 | 0.919 | 1.531 | X | N/A |
| 150 | 15 | 20 | 30 | 60 | 0.704 | 1.174 | X | N/A |
| 185 | 18.5 | 25 | 38 | 76 | 0.556 | 0.927 | X | N/A |
| 220 | 22 | 30 | 45 | 90 | 0.470 | 0.783 | X | N/A |
| 300 | 30 | 40 | 58 | 116 | 0.364 | 0.607 | X | N/A |
| 370 | 37 | 50 | 80 | 160 | 0.264 | 0.440 | O | N/A |
| 450 | 45 | 60 | 100 | 200 | 0.211 | 0.352 | O | N/A |
| 550 | 55 | 75 | 128 | 256 | 0.165 | 0.275 | O | N/A |
| 750 | 75 | 100 | 165 | 330 | 0.128 | 0.213 | O | N/A |

DC Input Reactor

200V~230V/ 50~60Hz (Three-phase power)

| Type | KW | HP | Rated Amps (Arms) | Max. Continuous Amps (Arms) | DC Reactor (mH) | DC Reactor Delta Part# |
|------|------|-----|-------------------|-----------------------------|-----------------|------------------------|
| 040 | 4 | 5 | 20 | 40 | 1.273 | N/A |
| 055 | 5.5 | 7.5 | 24 | 48 | 1.061 | N/A |
| 075 | 7.5 | 10 | 30 | 60 | 0.740 | N/A |
| 110 | 11 | 15 | 45 | 90 | 0.498 | N/A |
| 150 | 15 | 20 | 58 | 116 | 0.375 | N/A |
| 185 | 18.5 | 25 | 77 | 154 | 0.331 | N/A |
| 220 | 22 | 30 | 87 | 174 | 0.293 | N/A |
| 300 | 30 | 40 | 132 | 264 | 0.193 | N/A |
| 370 | 37 | 50 | 161 | 322 | 0.158 | N/A |

380V~460V/ 50~60Hz (Three-phase power)

| Type | KW | HP | Rated Amps (Arms) | Max. Continuous Amps (Arms) | DC Reactor (mH) | DC Reactor Delta Part# |
|------|------|-----|-------------------|-----------------------------|-----------------|------------------------|
| 040 | 4 | 5 | 11.5 | 23 | 4.244 | N/A |
| 055 | 5.5 | 7.5 | 13 | 26 | 3.754 | N/A |
| 075 | 7.5 | 10 | 17 | 34 | 2.871 | N/A |
| 110 | 11 | 15 | 23 | 46 | 2.122 | N/A |
| 150 | 15 | 20 | 30 | 60 | 1.627 | N/A |
| 185 | 18.5 | 25 | 38 | 76 | 1.284 | N/A |
| 220 | 22 | 30 | 45 | 90 | 1.085 | N/A |
| 300 | 30 | 40 | 58 | 116 | 0.842 | N/A |
| 370 | 37 | 50 | 80 | 160 | built-in | N/A |
| 450 | 45 | 60 | 100 | 200 | built-in | N/A |
| 550 | 55 | 75 | 128 | 256 | built-in | N/A |
| 750 | 75 | 100 | 165 | 330 | built-in | N/A |

THD (Total Harmonic Distortion)

| Motor Drive Spec. | Without Built-In Reactor | | | | With Built-in DC Reactor |
|-------------------|----------------------------------------------------------------------------------------|------------|-------------------------------|-----------------------|--------------------------|
| Reactor Spec. | 3% Input AC Reactor | DC Reactor | DC Reactor + 3% Input Reactor | DC + 5% Input Reactor | 3% Input Reactor |
| THD | 44% | 46% | 34% | 30% | 34% |
| Note: | THD may vary due to different installation conditions and environment (wires, motors). | | | | |

According to IEC61000-3-12, DC Reactor is designed with 4% system impedance, and AC Reactor is designed with 3% system impedance.

6-5 Zero Phase Reactor

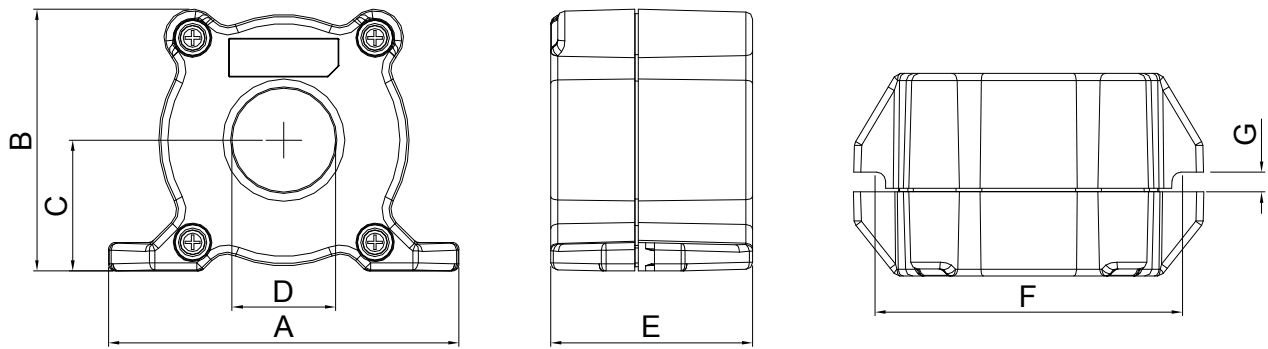

unit: mm (inch)

| Model | A | B | C | D | E | F | G(Ø) | Torque |
|-----------|----------------|-----------------|-----------------|---------------|-----------------|---------------|----------------|-------------|
| RF008X00A | 98 (3.858) | 73 (2.874) | 36.5 (1.437) | 29 (1.142) | 56.5 (2.224) | 86 (3.386) | 5.5 (0.217) | 8~ 10kgf/cm |
| RF004X00A | 110 (4.331) | 87.5 (3.445) | 43.5 (1.713) | 36 (1.417) | 53 (2.087) | 96 (3.780) | 5.5 (0.217) | 8~ 10kgf/cm |

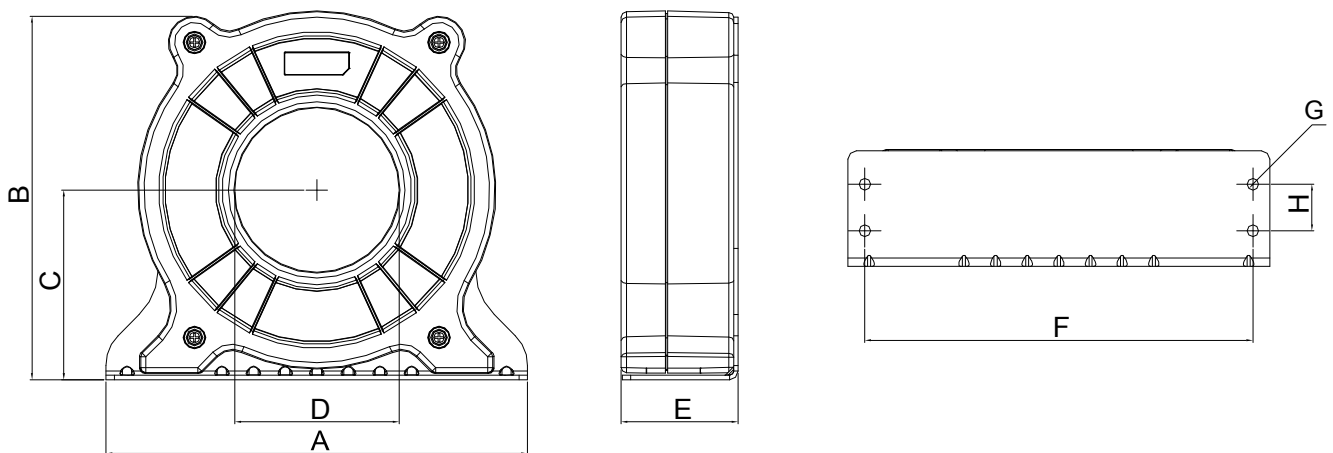

unit: mm (inch)

| model | A | B | C | D | E | F | G(Ø) | H | Torque |
|-----------|----------------|------------------|---------------|---------------|-----------------|----------------|----------------|---------------|-------------|
| RF002X00A | 200 (7.874) | 172.5 (6.791) | 90 (3.543) | 78 (3.071) | 55.5 (2.185) | 184 (7.244) | 5.5 (0.217) | 22 (0.866) | 40~45kgf/cm |

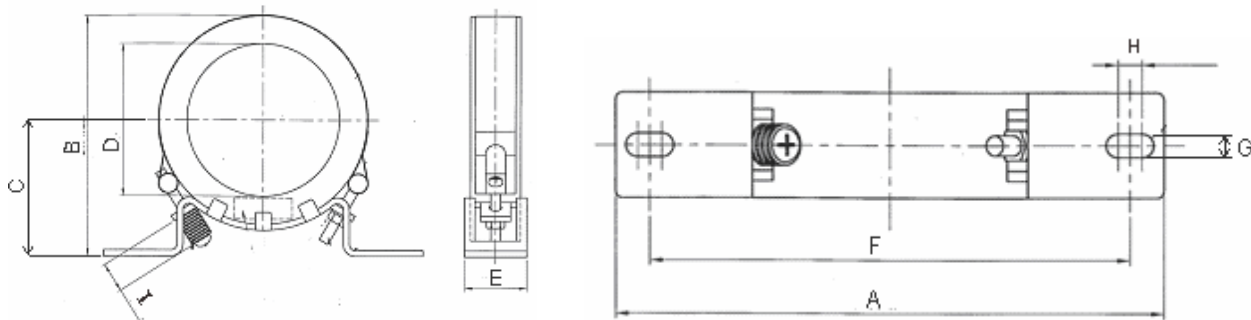

unit: mm (inch)

| model | A | B | C | D | E | F | G(Ø) | H | I | Torque |
|-----------|------------|------------|------------|------------|-----------|------------|------------|------------|-----------|-------------|
| RF300X00A | 241(9.488) | 217(8.543) | 114(4.488) | 155(6.102) | 42(1.654) | 220(8.661) | 6.5(0.256) | 7.0(0.276) | 20(0.787) | 40~45kgf/cm |

| Reactor model (Note) | Recommended Wire Size | | Wiring Method | Qty | Applicable Motor Drive |
|----------------------|-----------------------|-------------------------|---------------|-----|----------------------------------------------------------------------------------------------------------|
| RF008X00A | ≤ 8 AWG | ≤ 8.37 mm ² | Diagram A | 1 | VFD022ED21S VFD037ED21S VFD040ED23S VFD040ED43S |
| RF004X00A | ≤ 4 AWG | ≤ 21.15 mm ² | Diagram A | 1 | VFD055ED23S VFD075ED23S VFD110ED23S VFD055ED43S VFD075ED43S VFD110ED43S VFD150ED43S VFD185ED43S |
| RF002X00A | ≤ 2 AWG | ≤ 33.62 mm ² | Diagram A | 1 | VFD150ED23S VFD185ED23S VFD220ED23S VFD220ED43S VFD300ED43S |
| RF300X00A | ≤ 300 MCM | ≤ 152 mm ² | Diagram A | 1 | VFD300ED23S VFD370ED23S VFD370ED43S VFD450ED43S VFD550ED43S VFD750ED43S |

Note: 600V insulated cable wire

Diagram A

Put all wires through at least one core without winding

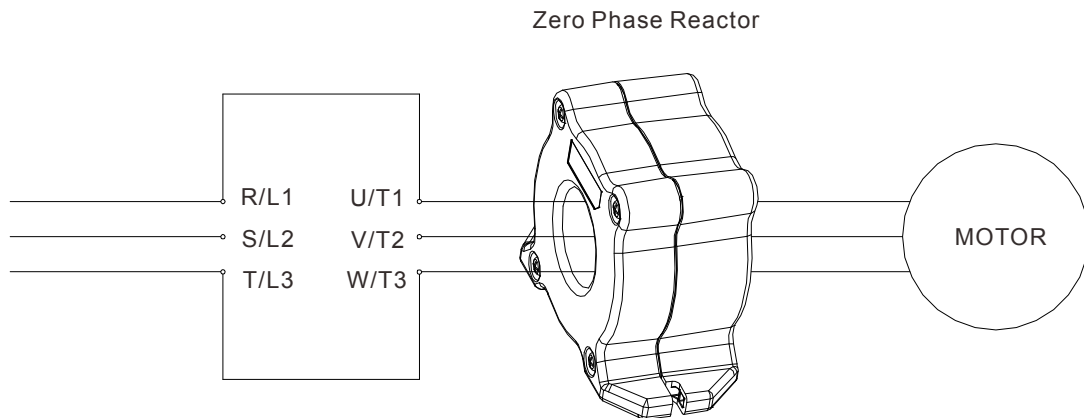

Note 1: The table above gives approximate wire size for the zero phase reactors but the selection is ultimately governed by the type and diameter of cable fitted i.e. the cable must fit through the center hole of zero phase reactors.

Note 2: Only the phase conductors should pass through, not the earth core or screen.

Note3: When long motor output cables are used an output zero phase reactor may be required to reduce radiated emissions from the cable.

6-6 EMI Filter

The following table shows external EMC filter models for each ED-S series motor drive.

Choose corresponding zero phase reactor and applicable shielding cable according to required noise emission and electromagnetic disturbance rating, to make the best assembly and restrain electromagnetic disturbance. If radiation emission (RE) is ignored, and only needs conducted emission (CE) to reach EN55011 Class A on site, zero phase reactor does not need to add at input side, and it can reach the standard of EMC.

220V models

| VFD-ED | | | EMI Filter Model # | Zero Phase Inverter | | Carrier Frequency | EN12015 | |
|--------|---------------------|-------------------------|--------------------|---------------------|---------------------|--------------------------------------|-------------------------------------|--------------------|
| Frame | Motor Drive model # | Rated Input Current (A) | | Input side (R/S/T) | Output side (U/V/W) | | Conducted Emission | Radiation Emission |
| | | | | | | | Length of output shielded cable 50m | |
| B | VFD022ED21S | 24 | B84142A0042R122 | RF008X00A | - | Carrier frequency by factory setting | CLASS A | CLASS A |
| | VFD037ED21S | 34 | B84142A0042R122 | RF008X00A | - | | CLASS A | CLASS A |
| | VFD040ED23S | 20 | EMF035A23A | RF008X00A | - | | CLASS A | CLASS A |
| C | VFD055ED23S | 23 | EMF056A23A | RF004X00A | - | | CLASS A | CLASS A |
| | VFD075ED23S | 30 | EMF056A23A | RF004X00A | - | | CLASS A | CLASS A |
| | VFD110ED23S | 47 | EMF056A23A | RF004X00A | - | | CLASS A | CLASS A |
| D | VFD150ED23S | 56 | B84143D0150R127 | RF002X00A | - | | CLASS A | CLASS A |
| | VFD185ED23S | 73 | B84143D0150R127 | RF002X00A | - | | CLASS A | CLASS A |
| | VFD220ED23S | 90 | B84143D0150R127 | RF002X00A | - | | CLASS A | CLASS A |
| E | VFD300ED23S | 132 | B84143D0150R127 | RF002X00A | - | | CLASS A | CLASS A |
| | VFD370ED23S | 161 | B84143D0200R127 | RF300X00A | - | CLASS A | CLASS A | |

460V models

| VFD-ED | | | EMI Filter model # | Zero Phase Reactor | | Carrier Frequency | EN12015 | |
|--------|---------------------|-------------------------|--------------------|--------------------|---------------------|--------------------------------------|-------------------------------------|--------------------|
| Frame | Motor Drive model # | Rated Input Current (A) | | Input Side (R/S/T) | Output Side (U/V/W) | | Conducted Emission | Radiation Emission |
| | | | | | | | Length of output Shielded Cable 50m | |
| B | VFD040ED43S | 11.5 | EMF018A43A | RF008X00A | - | Carrier Frequency by Factory Setting | CLASS A | CLASS A |
| C | VFD055ED43S | 14 | EMF033A43A | RF004X00A | - | | CLASS A | CLASS A |
| | VFD075ED43S | 17 | EMF033A43A | RF004X00A | - | | CLASS A | CLASS A |
| | VFD110ED43S | 24 | EMF033A43A | RF004X00A | - | | CLASS A | CLASS A |
| | VFD150ED43S | 30 | B84143D0075R127 | RF004X00A | - | | CLASS A | CLASS A |
| | VFD185ED43S | 37 | B84143D0075R127 | RF004X00A | - | | CLASS A | CLASS A |
| D | VFD220ED43S | 47 | B84143D0090R127 | RF002X00A | - | | CLASS A | CLASS A |
| | VFD300ED43S | 58 | B84143D0090R127 | RF002X00A | - | | CLASS A | CLASS A |
| E | VFD370ED43S | 80 | B84143D0200R127 | RF300X00A | - | | CLASS A | CLASS A |
| | VFD450ED43S | 100 | B84143D0200R127 | RF300X00A | - | | CLASS A | CLASS A |
| | VFD550ED43S | 128 | B84143D0200R127 | RF300X00A | - | | CLASS A | CLASS A |
| | VFD750ED43S | 165 | B84143D0200R127 | RF300X00A | - | | CLASS A | CLASS A |

EMI Filter Schematic Diagrams

EMI Filter model #: EMF018A43A

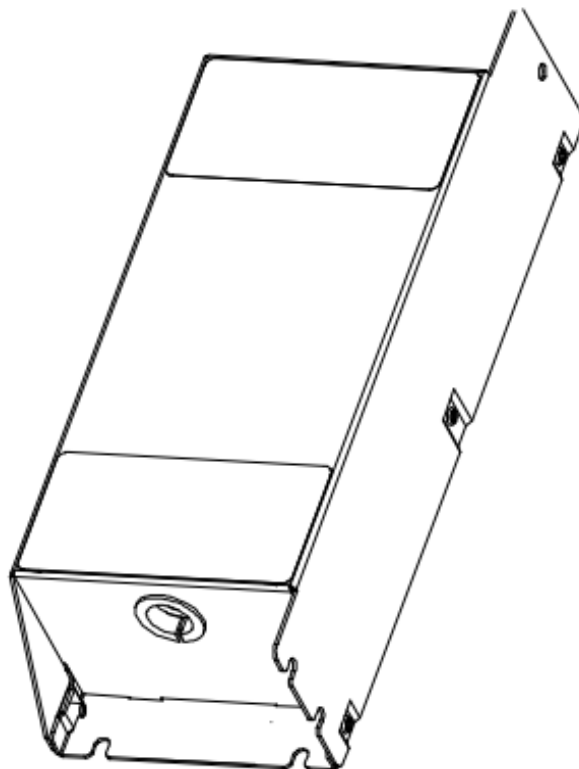
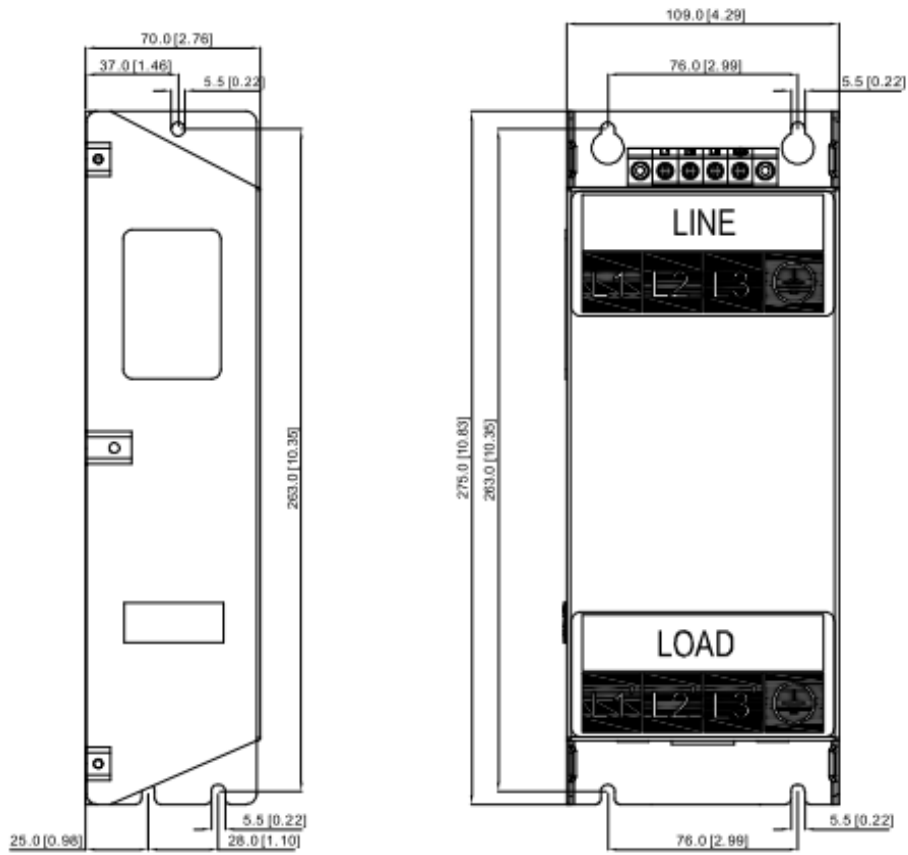

EMI Filter model #: EMF035A23A、EMF033A43A

7

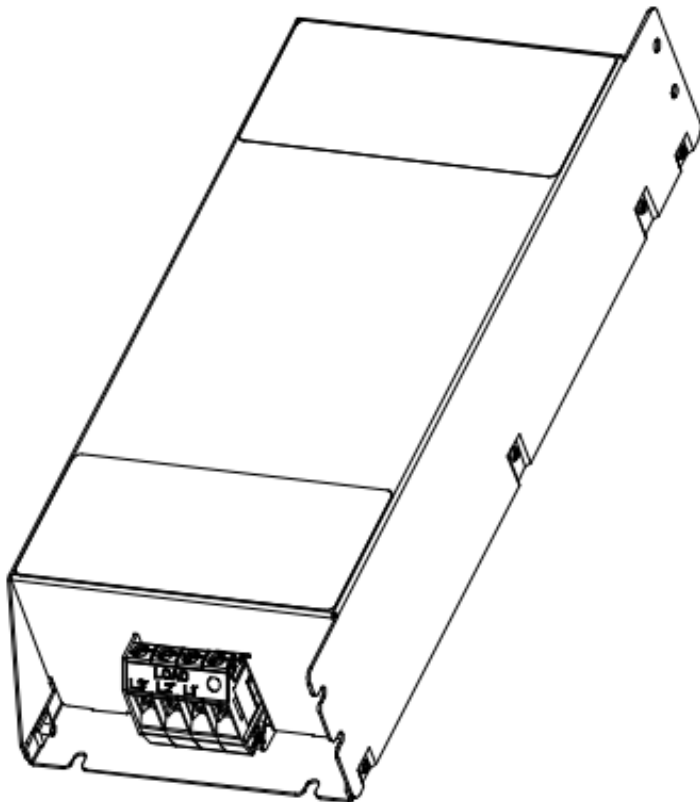
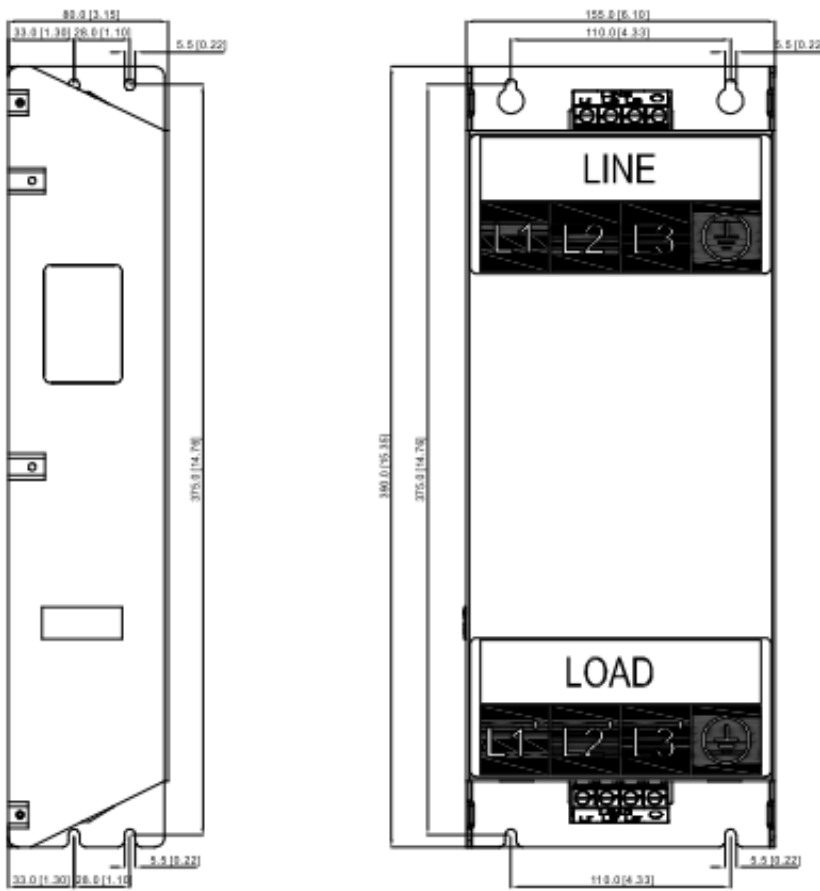

EMI Filter model #: EMF056A23A

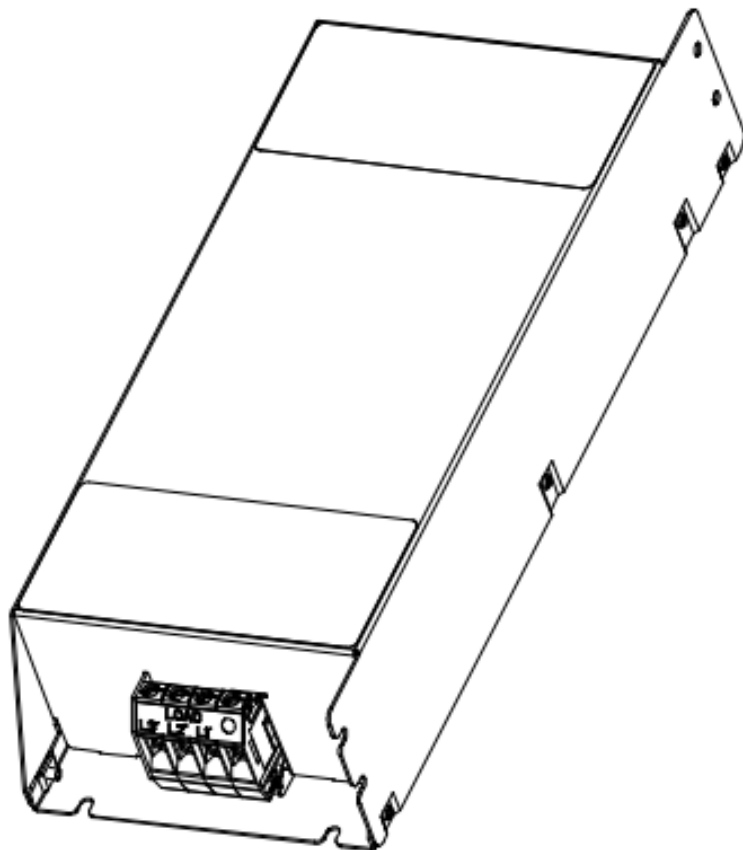
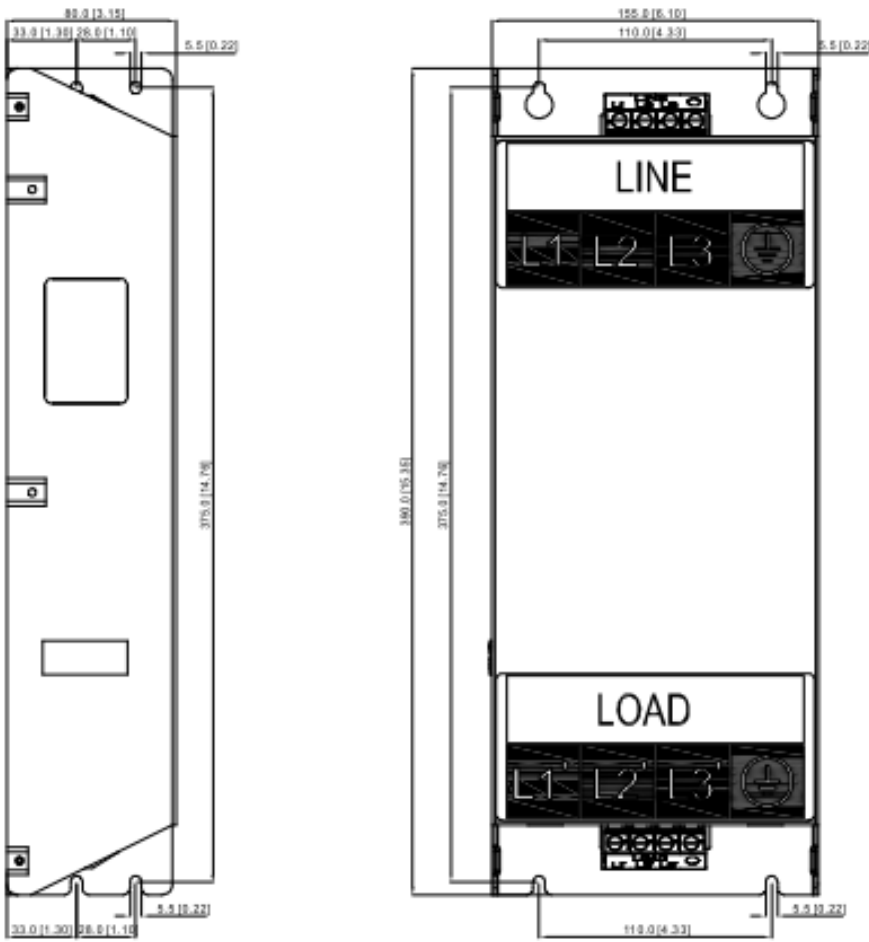

EMI Filter model #: B84143D0075R127; B84143D0090R127

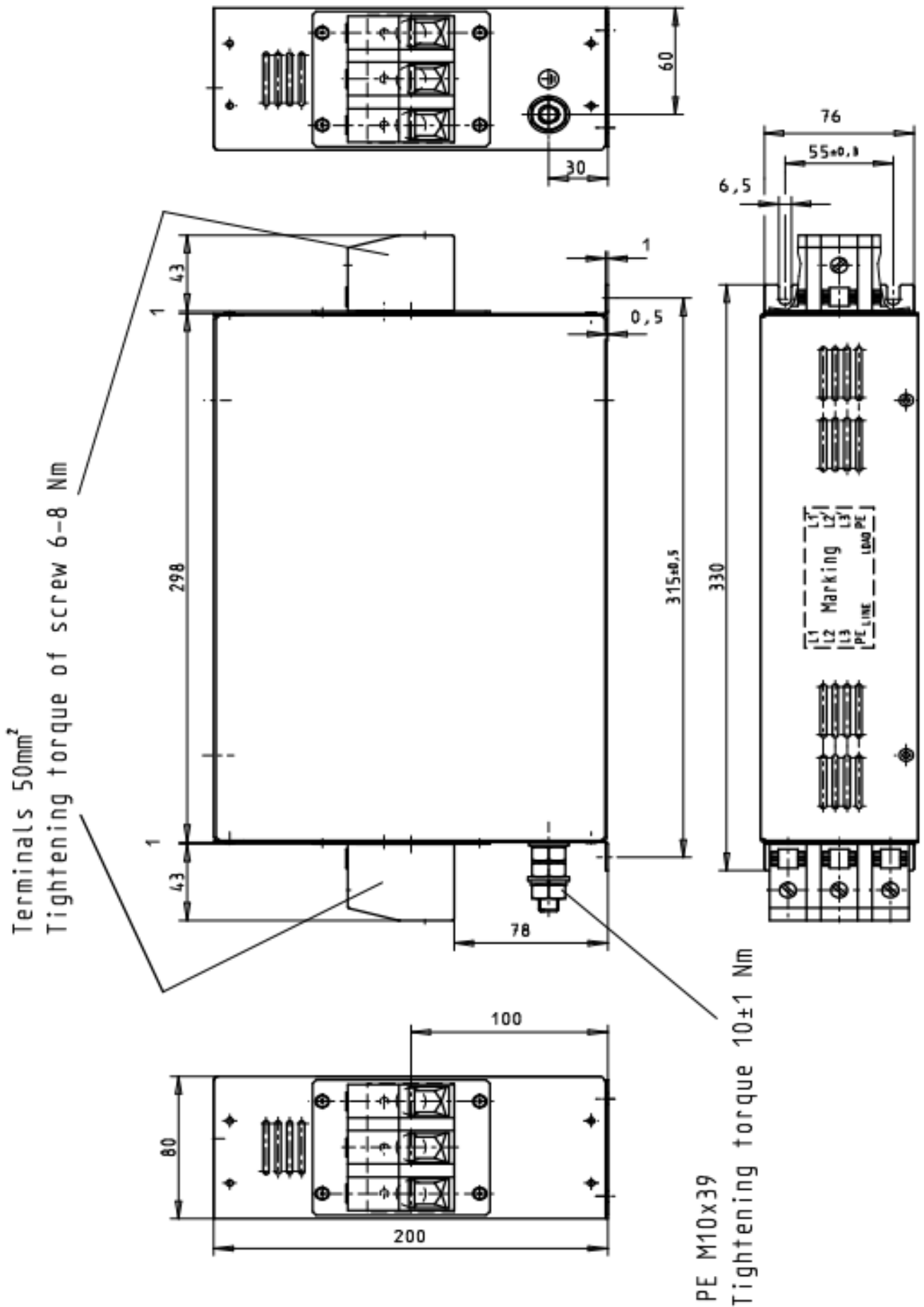

EMI Filter model #: B84143D0150R127

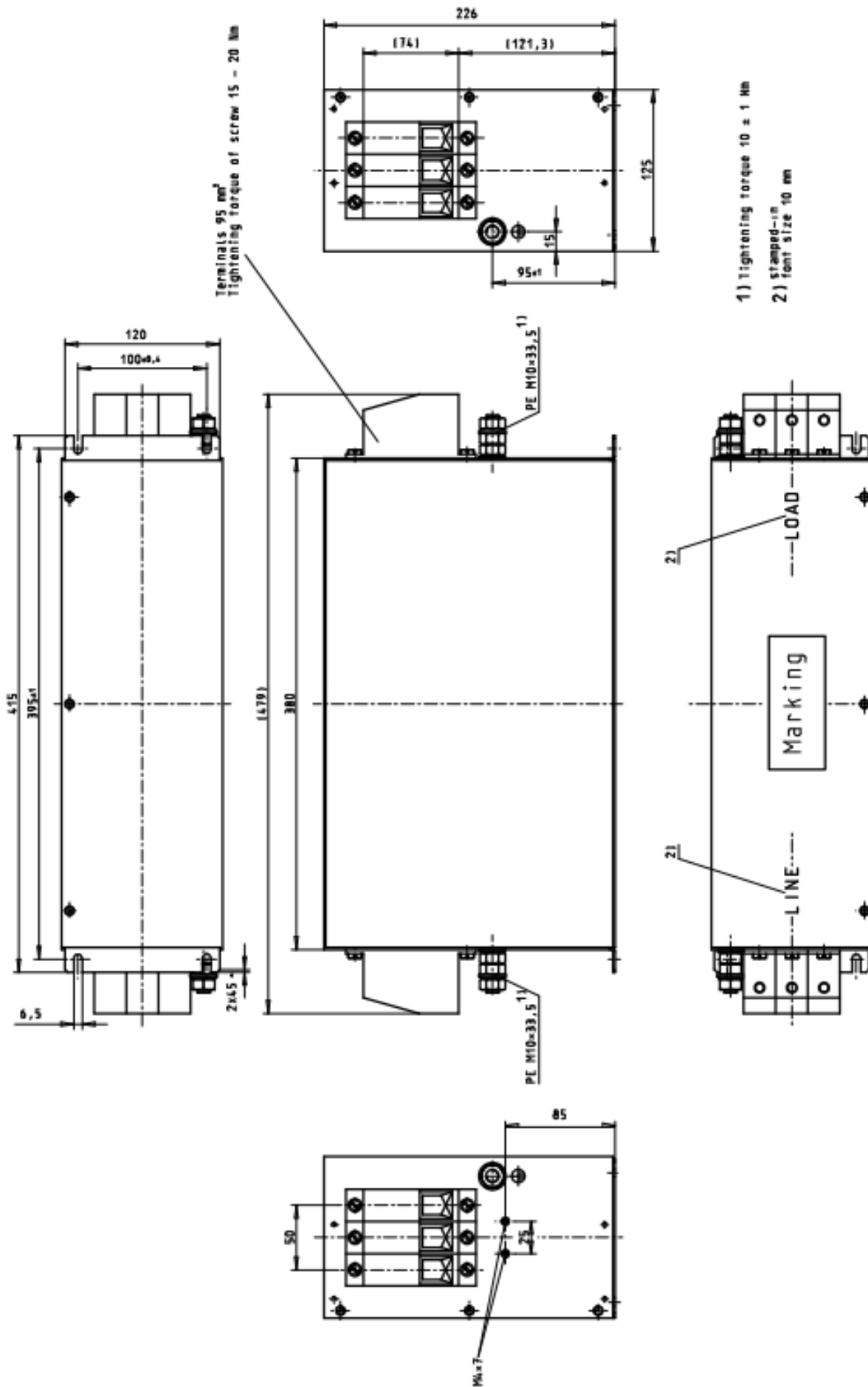

EMI Filter model #: B84143D0200R127

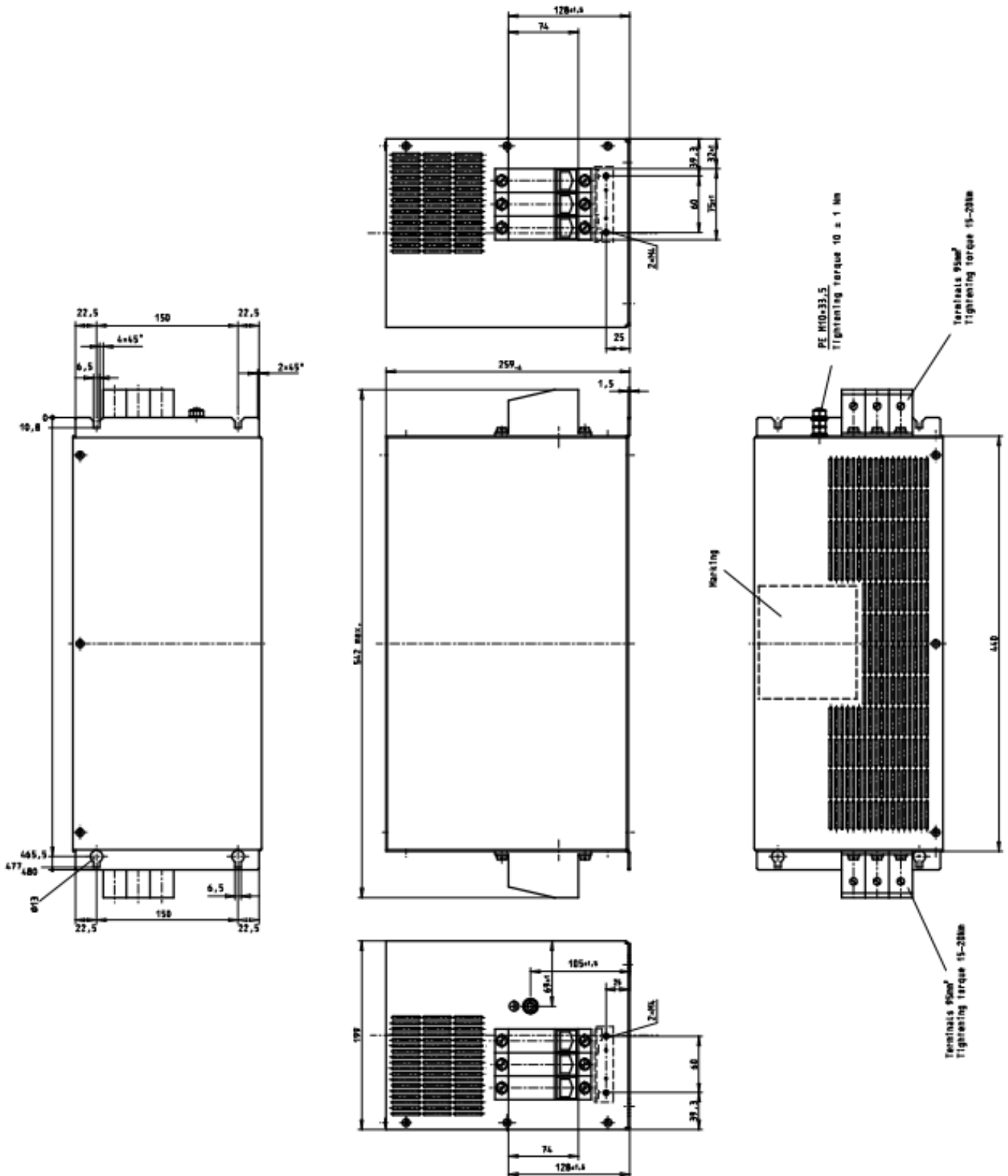

EMI Filter model #: B84142A0042R122

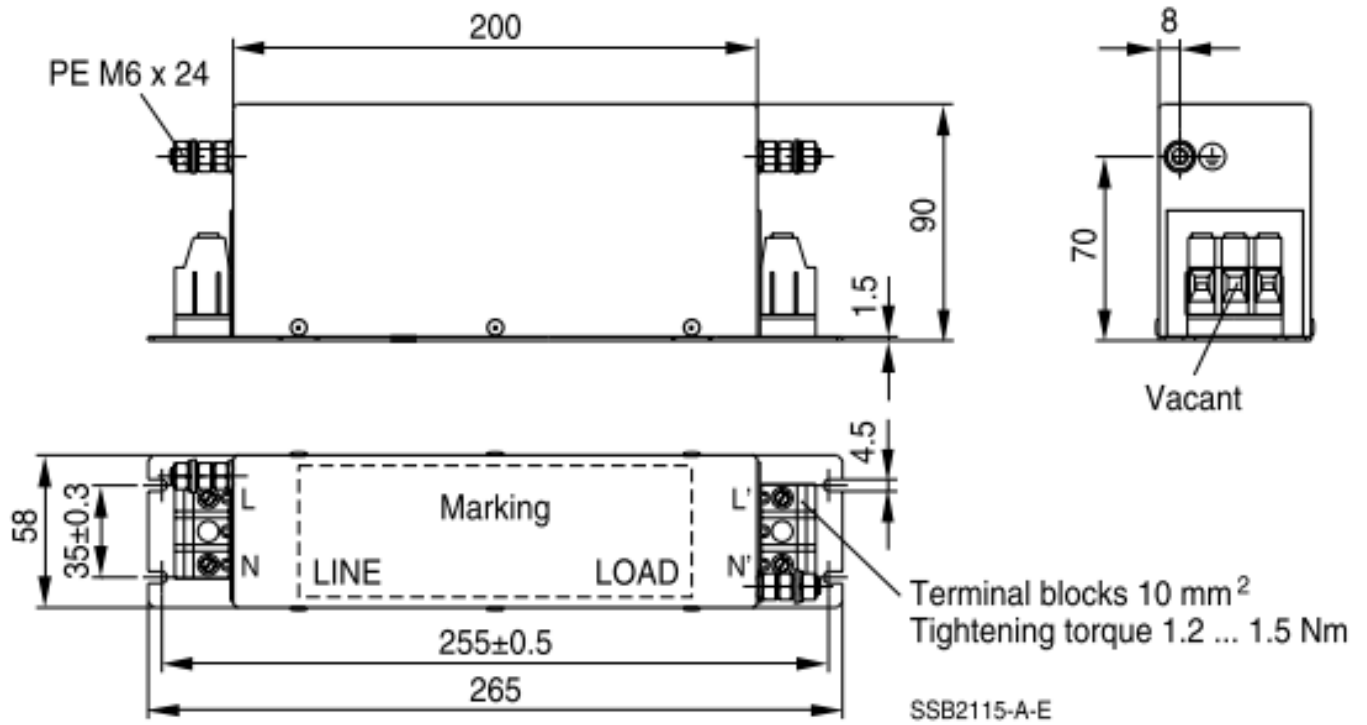

EMI Filter Installation

All electrical equipment, including AC motor drives, will generate high-frequency/low-frequency noise and will interfere with peripheral equipment by radiation or conduction when in operation. By using an EMI filter with correct installation, much interference can be eliminated. It is recommended to use DELTA EMI filter to have the best interference elimination performance.

We assure that it can comply with following rules when AC motor drive and EMI filter are installed and wired according to user manual:

- **EN61000-6-4**
- **EN61800-3: 1996**
- **EN55011: (1991) Class A Group 1 (1st Environment, restricted distribution)**
- **European Standards: EN12015 & EN12016**

General precaution

1. EMI filter and AC motor drive should be installed on the same metal plate.
2. Install AC motor drive on footprint EMI filter or install EMI filter as close as possible to the AC motor drive.
3. Wire as short as possible.
4. Metal plate should be grounded.
5. The cover of EMI filter and AC motor drive or grounding should be fixed on the metal plate and the contact area should be as large as possible.

Choose suitable motor cable and precautions

Improper installation and choice of motor cable will affect the performance of EMI filter. Be sure to observe the following precautions when selecting motor cable.

1. Use the cable with shielding (double shielding is the best).
2. The shielding on both ends of the motor cable should be grounded with the minimum length and maximum contact area.
3. Remove any paint on metal saddle for good ground contact with the plate and shielding.

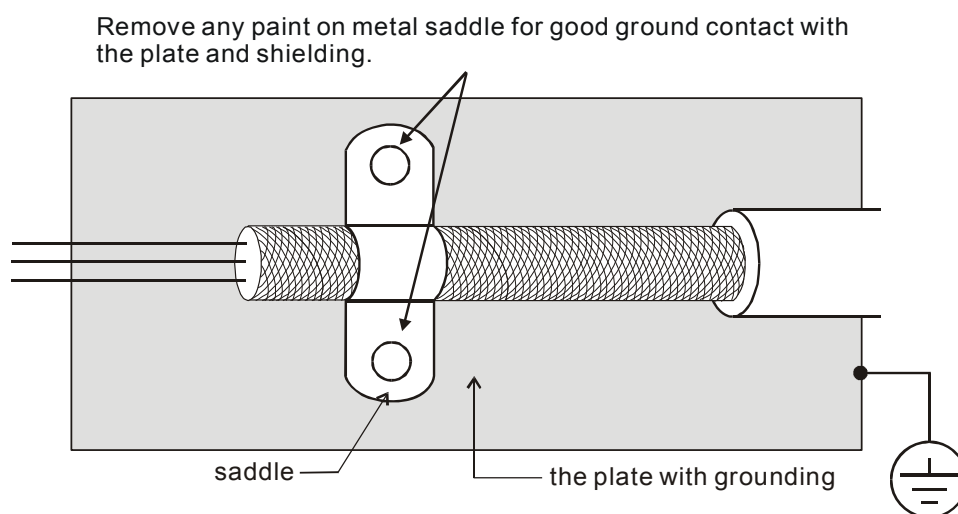

Figure 1

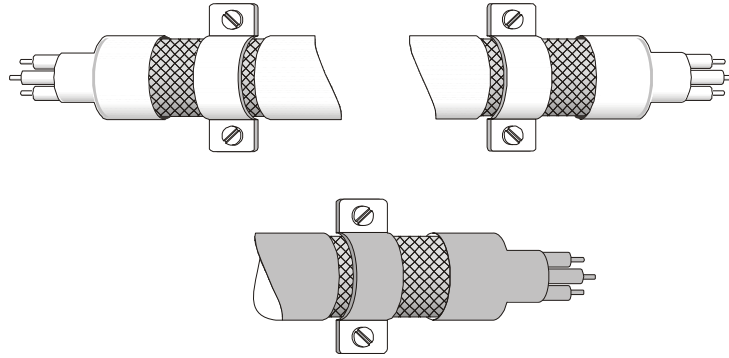

Figure 2

The length of motor cable

1. Required cable length when the motor drive is at full load.
 - a. Non-shielded cable: For models of 5.5kW (7.5HP) and below, the maximum cable length is 100m (328ft). For 7.5kW(10HP) and above, the maximum cable length is 200m(656ft)
 - b. Shielded cable: For models of 5.5kw (7.5HP) and below, the maximum cable length is 50m (165ft). For models of 7.5kW (10HP), the maximum cable length is 100m (328ft).
 - c. In order to be compatible with the European Standards EN12015 & EN12016, it is required not to only follow the precautions mentioned on page6-10, but also required to satisfy one of the two conditions below:
 - Use shielded cables
 - The length of motor cable has to be shorter than 2m (6ft).

If the cable length is longer than the recommended lengths above, it will be necessary to install an output reactor.

NOTE

- If the length is too long, the stray capacitance between cables will increase and may cause leakage current. It will activate the protection of over current, increase leakage current or not insure the correction of current display. The worst case is that AC motor drive may damage.
- If more than one motor is connected to the AC motor drive, the total wiring length is the sum of the wiring length from AC motor drive to each motor.
- For the 460V series AC motor drive, when an overload relay is installed between the drive and the motor to protect motor overheating, the connecting cable must be shorter than 50m. However, an overload relay malfunction may still occur. To prevent the malfunction, install an output reactor (optional) to the drive or lower the carrier frequency setting (Pr.00-12).

2. Consequence of the surge voltages on the motor

When a motor is driven by an AC motor drive of PWM type, the motor terminals will experience surge voltages easily due to components conversion of AC motor drive and cable capacitance. When the motor cable is very long (especially for the 460V series), surge voltages may reduce insulation quality. To prevent this situation, please follow the rules below:

- Use a motor with enhanced insulation.
- Connect an output reactor (optional) to the output terminals of the AC motor drive
- The length of the cable between AC motor drive and motor should be as short as possible (10 to 20 m or less)
- For models 7.5hp and above:

| Insulation level of motor | 1000V | 1300V | 1600V |
|---------------------------|--------------|--------------|--------------|
| 460VAC input voltage | 20m(66ft) | 100m(328ft) | 400m(1312ft) |
| 230VAC input voltage | 400m(1312ft) | 400m(1312ft) | 400m(1312ft) |

- For models 5hp and less:

| Insulation level of motor | 1000V | 1300V | 1600V |
|---------------------------|-------------|-------------|-------------|
| 460VAC input voltage | 20m(66ft) | 50m(165ft) | 50m(165ft) |
| 230VAC input voltage | 100m(328ft) | 100m(328ft) | 100m(328ft) |



NOTE

Never connect phase lead capacitors or surge absorbers to the output terminals of the AC motor drive.

6-7 Digital Keypad



KPC-CC01



- A:** LED Display
Display frequency, current, voltage and error etc.
- B:** Status Indicator
F: Frequency Command
H: Output Frequency
U: User Defined Units
ERR: CAN Error Indicator
RUN: CAN Run Indicator
- C:** Function
(Refer to the chart follows for detail description)

| Key | Description | | | | |
|---------------------|------------------------------------------------------------------------------------------------------------------------------------------------------------------------------------------------------------------------------------------------------------------------------------------------------------------------------------------------------------------------------------------------------------------------------------------------------------------------------------------------------------------------------------------------------------------------------------------------------------|---------------------|------------------|-------------------|-----------------|
| ESC | ESC Key Press ESC key to return to the previous page. It also functions as a return to last category key in the sub-menu. | | | | |
| MENU | Menu Key Press MENU key under any condition will return to the main MENU. Menu content: <table style="width: 100%; border: none;"> <tr> <td style="width: 50%;">1. Parameter Detail</td> <td style="width: 50%;">3. Keypad locked</td> </tr> <tr> <td>2. Copy Parameter</td> <td>4. PLC Function</td> </tr> </table> | 1. Parameter Detail | 3. Keypad locked | 2. Copy Parameter | 4. PLC Function |
| 1. Parameter Detail | 3. Keypad locked | | | | |
| 2. Copy Parameter | 4. PLC Function | | | | |
| ENTER | ENTER Key Press ENTER and go to the next level. If it is the last level then press ENTER to execute the command. | | | | |
| HAND | HAND ON Key <ol style="list-style-type: none"> HAND key will operate according to the parameter settings when the source of HAND master frequency command and the source of HAND operation command is properly set,. The factory setting of the source command for frequency and operation are from the digital keypad. Press HAND key in stop status, the drive setting switches to the parameter setting of HAND. Press HAND key in during operation, the drive will come to stop then switches to the parameter setting of HAND. When process complete: H/A LED ON. | | | | |
| AUTO | Auto Operation Key <ol style="list-style-type: none"> AUTO function executes according to the parameter settings of the source of AUTO frequency and AUTO operation. The factory setting is the external terminal (source of operation is 4-20mA). Press the ATUO key in stop status, the drivel switches to auto-setting. Press the auto key during operation status, the drivel will come to stop and switch to auto-setting. When process complete: H/A LED is OFF | | | | |
| FWD/REV | Operation Direction Key <ol style="list-style-type: none"> FWD/REV key controls the operation direction but will NOT activate the drive. FWD: forward, REV: reverse. The drive operates in the direction as shown by the LED light. | | | | |
| RUN | Start Key <ol style="list-style-type: none"> This button is functional only when the keypad is the source of the command. This button allows the motor drive to run by following its settings. See Description of LED functions for LED status Press repeatedly the "RUN" button is allowed while the motor drive is stopping. | | | | |
| STOP | Stop Key. <ol style="list-style-type: none"> STOP key has the highest priority in command. Press STOP key, the drive will come to stop under any condition. The RESET key can be used to reset the drive when faults occur. If the RESET key is not responding, check MENU → Fault Records and check the most recent fault. | | | | |

Description of LED Functions

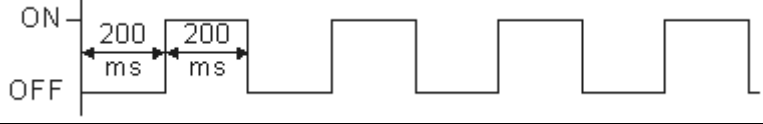
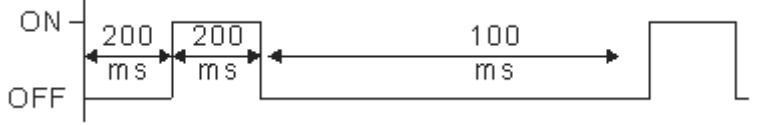
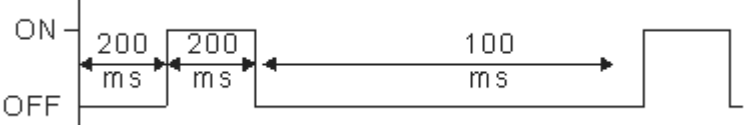
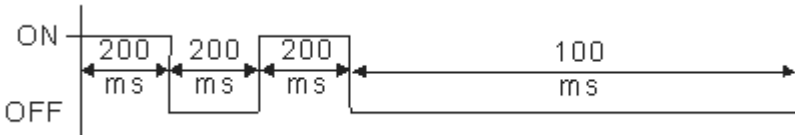
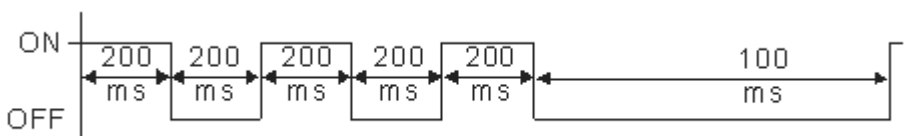
| LED | Description | |
|-----------------------------------------------------------------------------------|----------------------------------------------------------------------------------------------------------------------------------------------------------------------------------------------------------------------------------------------------------------------------|-------------------------------------------------------------------------------------------------------------------------|
|  | Steady ON: operation indicator of the AC motor drive, including DC brake, zero speed, standby, restart after fault and speed search. Blinking: drive is decelerating to stop or in the status of base block. Steady OFF: drive doesn't execute the operation command | |
|  | Steady ON: stop indicator of the AC motor drive. Blinking: drive is in the standby status. Steady OFF: drive doesn't execute "STOP" command. | |
|  | Operation Direction LED 『Green light= Forward』; 『Red light= Reversely』 Steady ON: the drive is running forward. Blinking: the drive is changing direction. Steady Off: the drive is running reversely. | |
| CANopen ~"RUN" | RUN (Green light): | |
| | LED status | Condition/State |
| | OFF | CANopen at initial No LED |
| | Blinking | CANopen at pre-operation  |
| | Single flash | CANopen at stopped  |
| ON | CANopen at operation status No LED | |
| CANopen ~"ERR" | ERR (Red light): | |
| | LED status | Condition/ State |
| | OFF | No Error |
| | Single flash | One message fail  |
| | Double flash | Guarding fail or heartbeat fail  |
| Triple flash | SYNC fail  | |
| ON | Bus off | |

Dimension

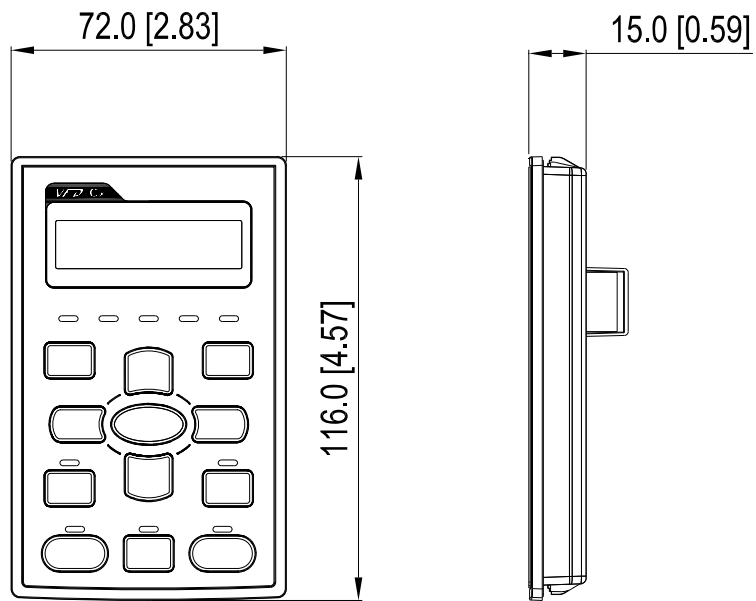

RJ45 Extension Lead for Digital Keypad

| Part # | Description |
|-----------|---------------------------------------------------|
| CBC-K3FT | 3 feet RJ45 extension lead (approximately 0.9m) |
| CBC-K5FT | 5 feet RJ45 extension lead (approximately 1.5 m) |
| CBC-K7FT | 7 feet RJ45 extension lead (approximately 2.1 m) |
| CBC-K10FT | 10 feet RJ45 extension lead (approximately 3 m) |
| CBC-K16FT | 16 feet RJ45 extension lead (approximately 4.9 m) |

6-8 USB/RS-485 Communication Interface IFD6530

⚠ Warning

- ✓ Read thoroughly this section before installation and putting it into use.
- ✓ The content of this section and the driver file may be revised without prior notice. Consult our distributors or download the most updated instruction/driver version at [AC Motor Drive > Optional](#)

Introduction

IFD6530 is a convenient RS-485-to-USB converter, which does not require external power-supply and complex setting process. It supports baud rate from 75 to 115.2kbps and auto switching direction of data transmission. In addition, it adopts RJ-45 in RS-485 connector for users to wire conveniently. And its tiny dimension, handy use of plug-and-play and hot-swap provide more conveniences for connecting all DELTA IABU products to your PC.

Applicable Models: All DELTA IABU products.

■ Application & Dimension:

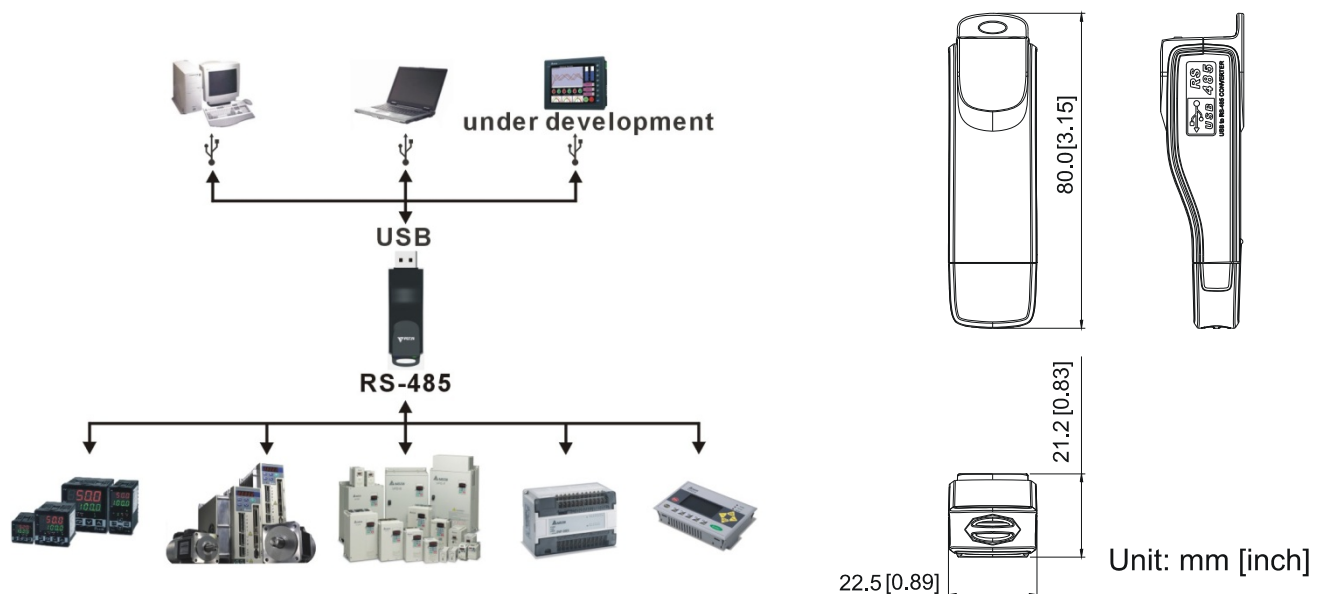

Specifications

| | |
|-----------------------------------------|------------------------------------------------------------------------------------|
| Power supply | No external power is needed |
| Power consumption | 1.5W |
| Isolated voltage | 2,500VDC |
| Baud rate | 75, 150, 300, 600, 1,200, 2,400, 4,800, 9,600, 19,200, 38,400, 57,600, 115,200 bps |
| RS-485 connector | RJ-45 |
| USB connector | A type (plug) |
| Compatibility | Full compliance with USB V2.0 specification |
| Max. cable length | RS-485 Communication Port: 100 m |
| Support RS-485 half-duplex transmission | |

RJ-45

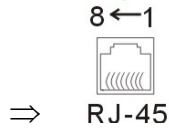

| PIN | Description |
|-----|-------------|
| 1 | Reserved |
| 2 | Reserved |
| 3 | GND |
| 4 | SG- |

| PIN | Description |
|-----|-------------|
| 5 | SG+ |
| 6 | GND |
| 7 | Reserved |
| 8 | +9V |

Preparation before Installing Driver

Extract the driver file (IFD6530_Drivers.exe) by following steps. You could find driver file (IFD6530_Drivers.exe) in the CD supplied with IFD6530.

Note: DO NOT connect IFD6530 to PC before extracting the driver file.

STEP 1

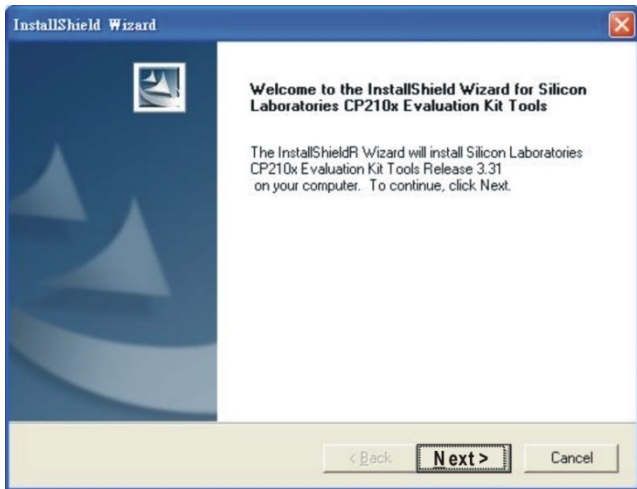

STEP 2

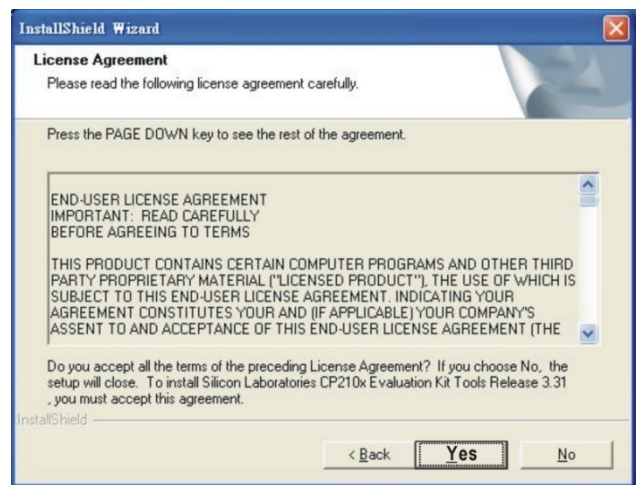

STEP 3

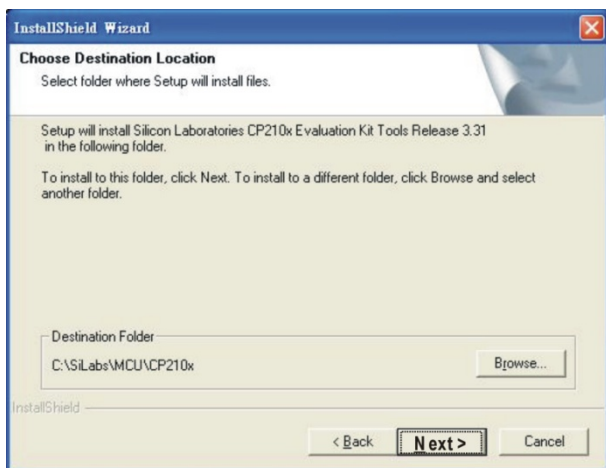

STEP 4

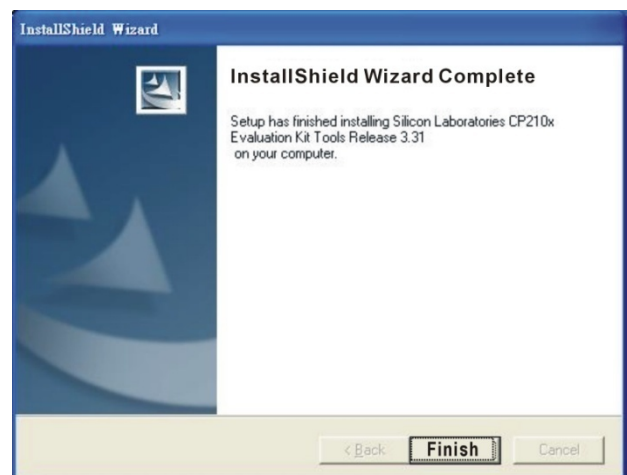

STEP 5

You should have a folder marked SiLabs under drive C. c:\ SiLabs

Installing the Driver

After connecting IFD6530 to PC, install driver by following steps below.

STEP 1



STEP 2

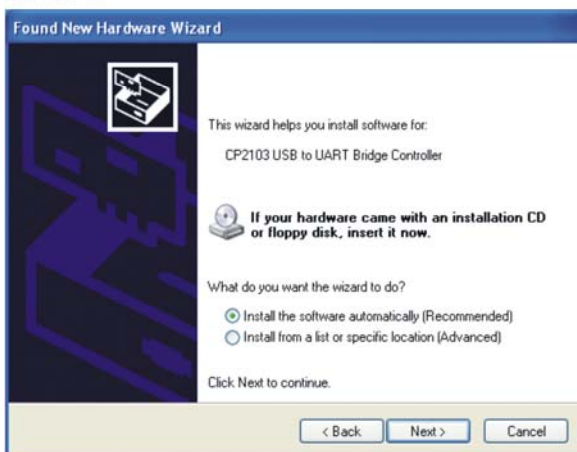

OR

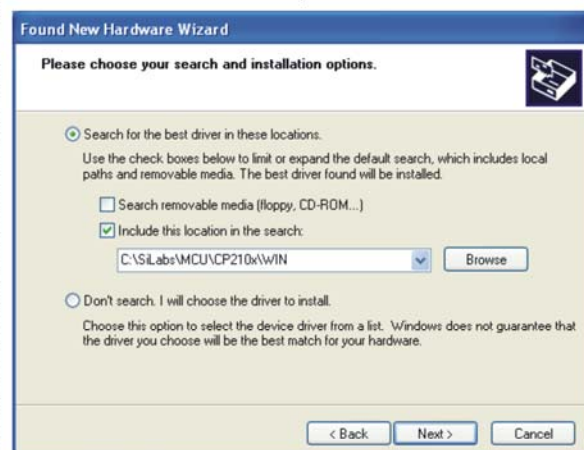
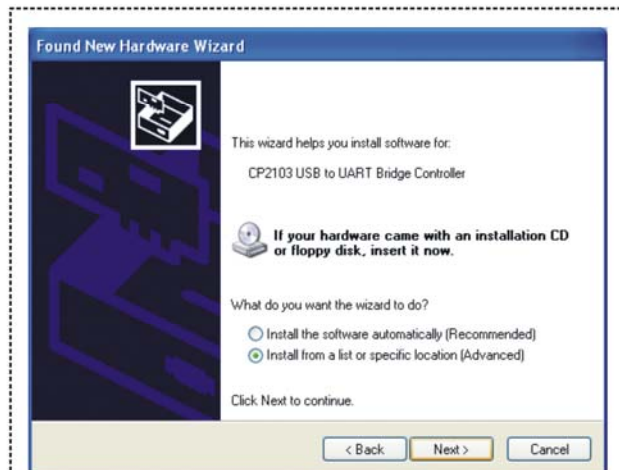

Browse and select directory, or enter
C:\SiLabs\MCU\CP210x\WIN

STEP 3

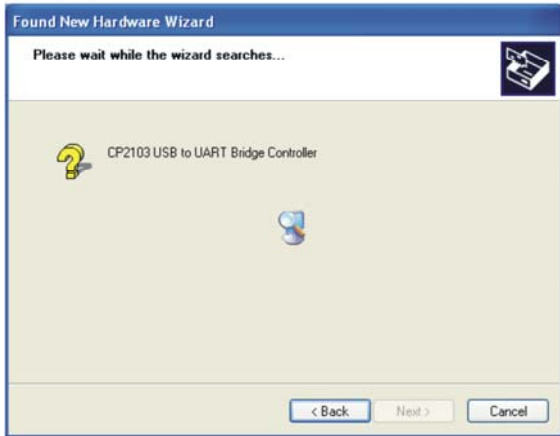

STEP 4



STEP 5

Repeat Step 1 to Step 4 to complete COM PORT setting.

LED Display

1. Steady Green LED ON: power is ON.
2. Blinking orange LED: data is transmitting.

07 Option Cards

Select applicable option cards for your drive or contact local distributor for suggestion.

To prevent drive damage during installation, remove the digital keypad and the cover before wiring. Refer to the following instruction.

Remove the top cover

Frame B, C & D Screw Torque: Kg-cm [lb.-in.]

Step 1

Loosen the 4 screws.
Then remove the top cover.

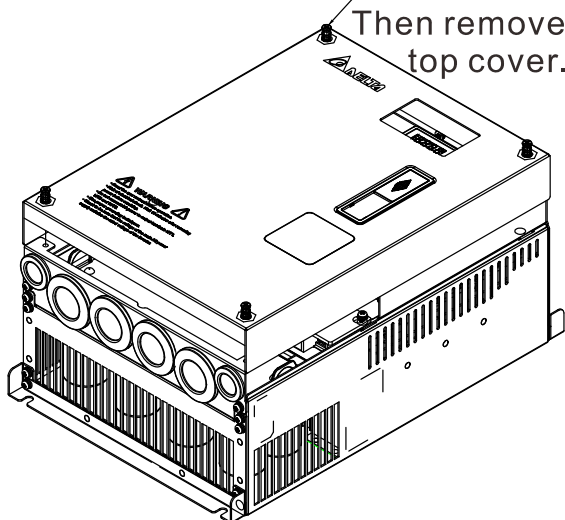

Step 2

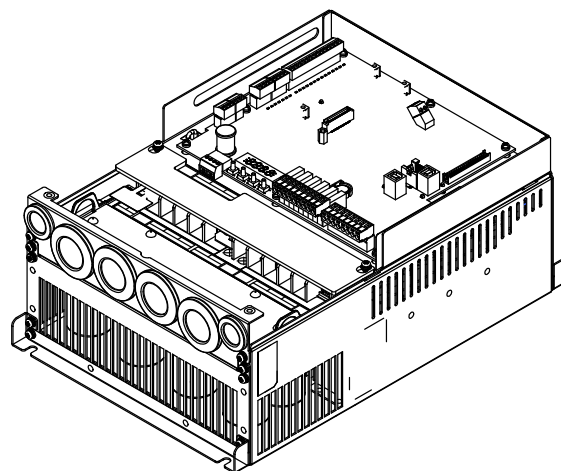

Step 3

Put back the top cover.
Then fasten the 4 screws,
Screw torque 15kgf-cm

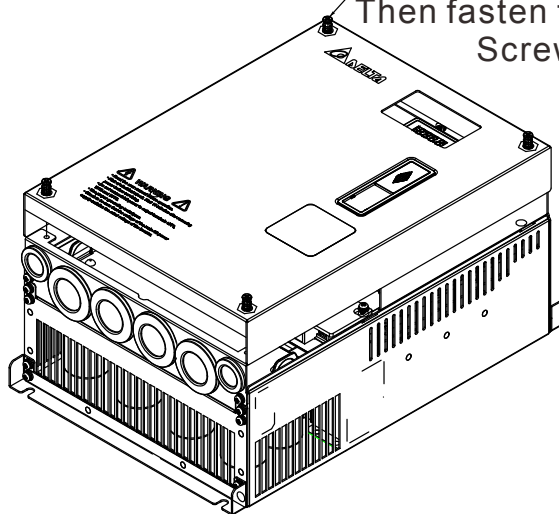

Frame E Screw Torque: Kg-cm [lb.-in.]

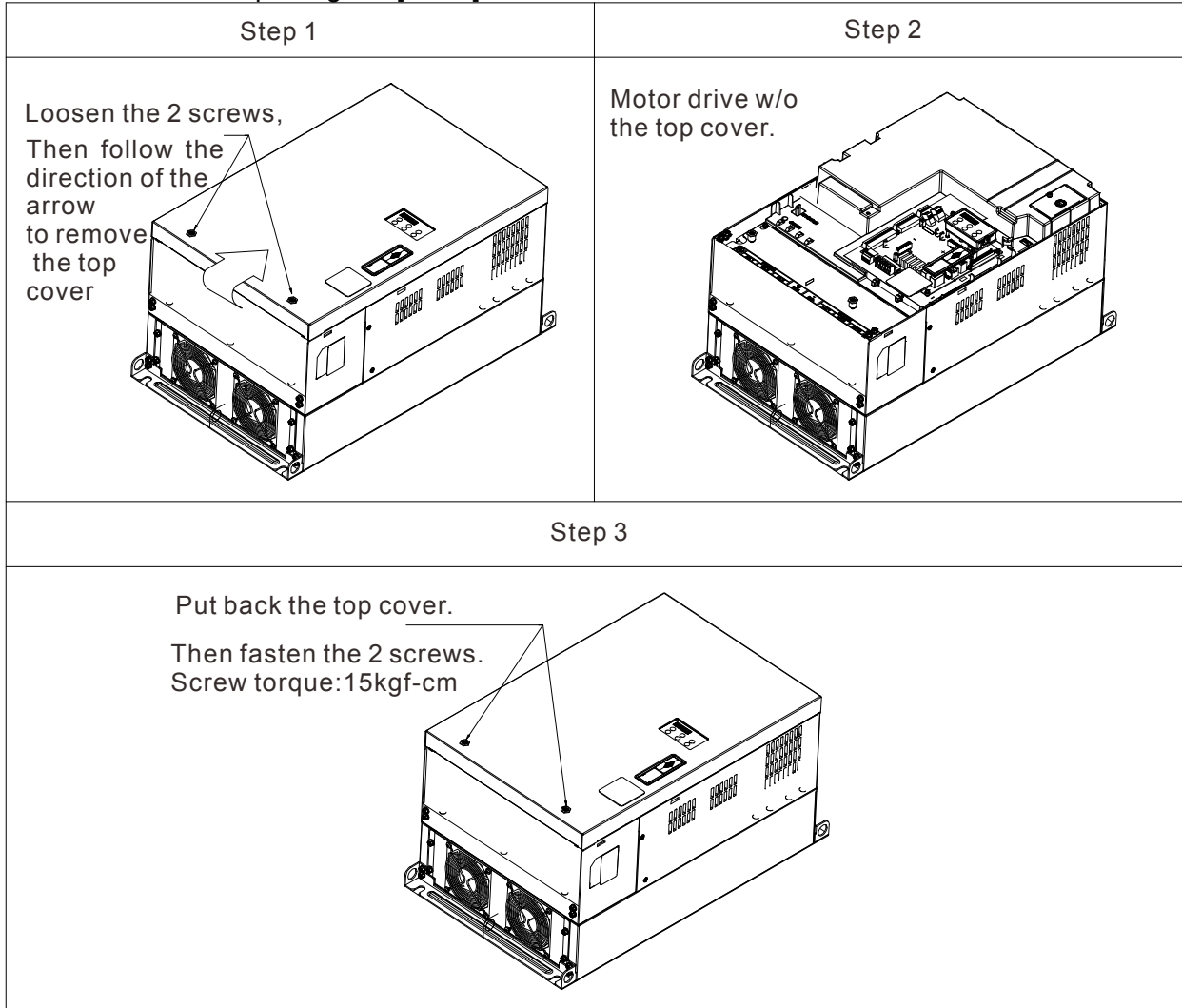

Vertical view of the motor drive & Screw's Specifications:

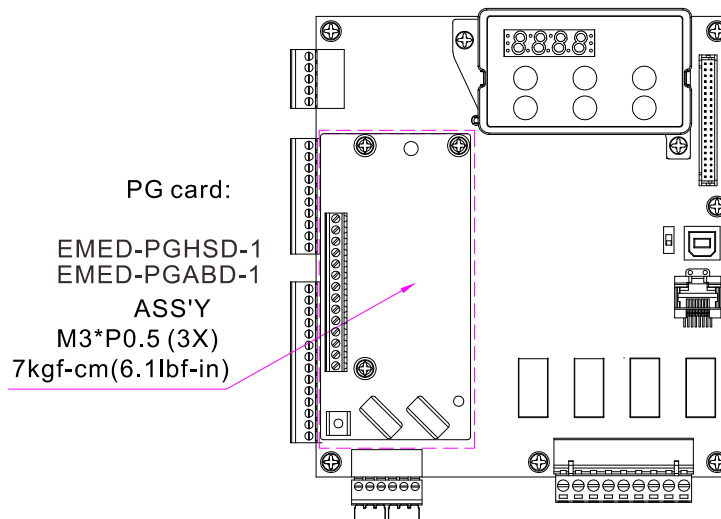

Screws' Specification for Option Card Terminal:

| PG Card | Wire Gauge | Torque |
|--------------|---------------------------------------|---------------------|
| EMED-PGABD-1 | 30~16AWG (0.05~1.31mm ²) | 1.6Kg-cm [1.4lb-in] |
| EMED-PGHSD-1 | 30~16AWG (0.05~1.31mm ²) | 1.6Kg-cm [1.4lb-in] |

7-1 EMED-PGABD-1

Applicable encoder: A/B/Z & U/V/W Absolute Encoders

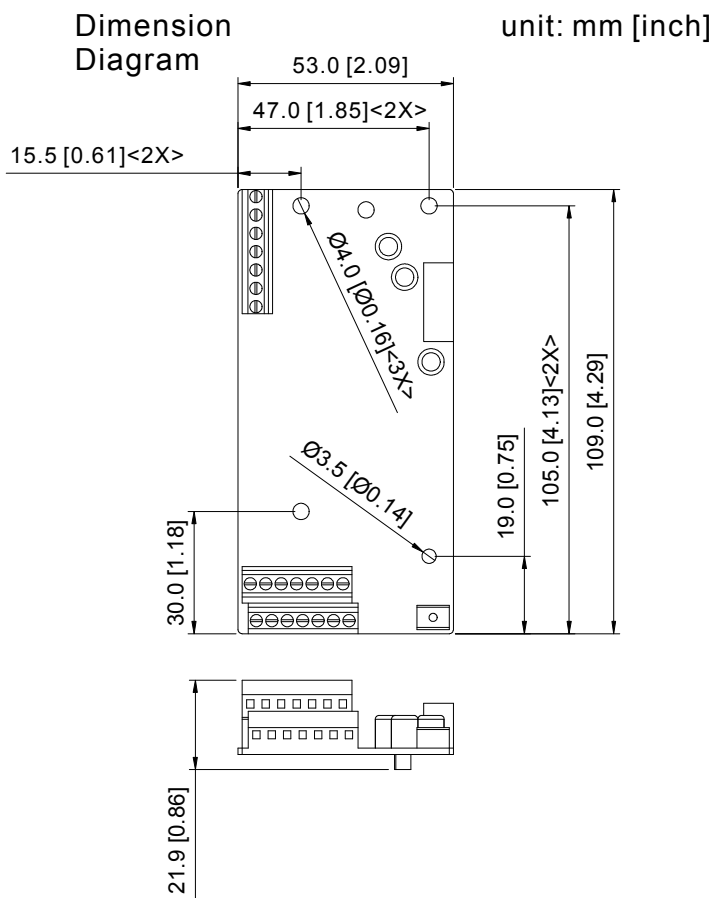
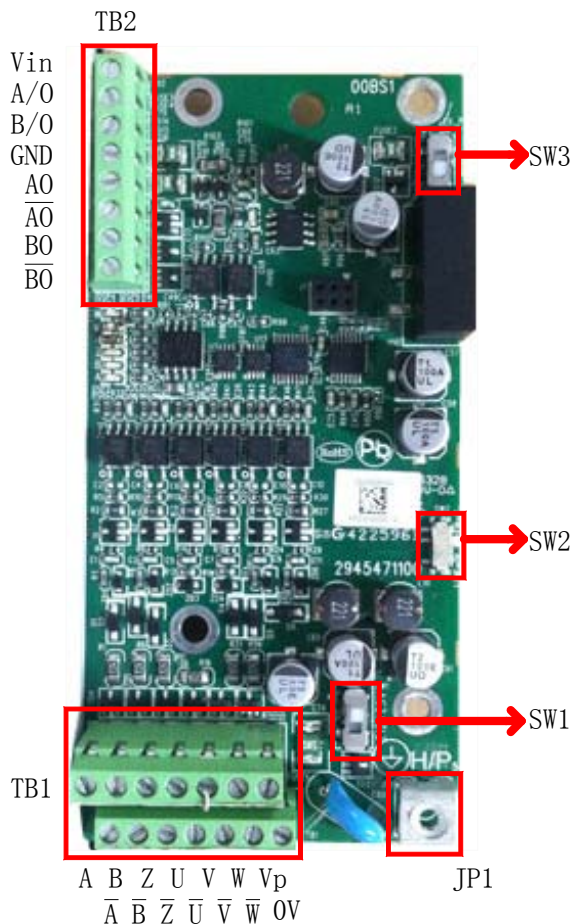

NOTE

- Verify if the SW1 is set to the correct output voltage before power on.
- Keep away from any high voltage line when wiring the motor drive to avoid interference.

Terminal Specification

| Terminals | | Descriptions |
|-----------|-------------------------------------------------------------------------------------|-------------------------------------------------------------------------------------------------------------------------------------------------------------------------------------------------------------------------------------------------------------------------------------------------------------------------------------------------------------------------------------|
| TB2 | Vin | Terminal for voltage input, to adjust the amplitude of output voltage at terminal A/O and terminal B/O. It also provides a 5V voltage to support line driver's signal. Vin voltage range: 8~24V, Max: 24V. |
| | A/O, B/O | Output signal of the push-pull frequency divider Factory setting: Output amplitude is about +24V. Use SW2 to cut off the internal default power. Input required power (i.e. output voltage's amplitude) DVI voltage range Max: 24V (Push-Pull Voltage Output) Max. output frequency: 100kHz Support frequency dividing output, the frequency dividing range: 1~31Hz. |
| | GND | Common ground terminal connecting to the host controller and the motor drive. |
| | AO, /AO, BO, /BO | Line driver pulse output signal (Line Driver RS422) Max. output frequency: 150kHz Support frequency dividing output, the frequency dividing range: 1~31Hz. |
| TB1 | VP | Power output of encoder Note: Use SW1 to set up output voltage Voltage: +5V±0.5V or +12V±1V Current: 200mA max |
| | 0V | Common power terminal of encoder |
| | A, \bar{A} , B, \bar{B} , Z, \bar{Z} | Incremental encoder signal input terminal Types of input signal: line drive, voltage output, push-pull, open-collector) Note: Different input signal needs different wiring method. See user manual for wiring diagrams. Max. input frequency: 150kHz |
| | U, \bar{U} , V, \bar{V} , W, \bar{W} | Absolute encoder signal input terminal Types of input signal: line drive, voltage, push-pull, open-collector) Note: Different input signal needs different wiring method. See user manual for wiring diagrams Max. input frequency: 150kHz |
| JP1 |  | Ground Terminal Connect the power supply of the motor drive to the ground. Support PG shielding |
| | SW1 | Switch between encoder's 5V/12V power. |
| | SW2 | Offline Detection Switch. Switch the SW2 to Line-D side to enable offline detection when Line-D input signal. Switch the SW2 to OPEN-C side to disable offline detection function when OPEN-C input signal. |
| | SW3 | Switch of power supply for frequency division Switch SW3 to INP side to provide 24V power for internal use. Switch SW3 to EXP side to provide 24V power for external use (client). |

Applicable encoders:

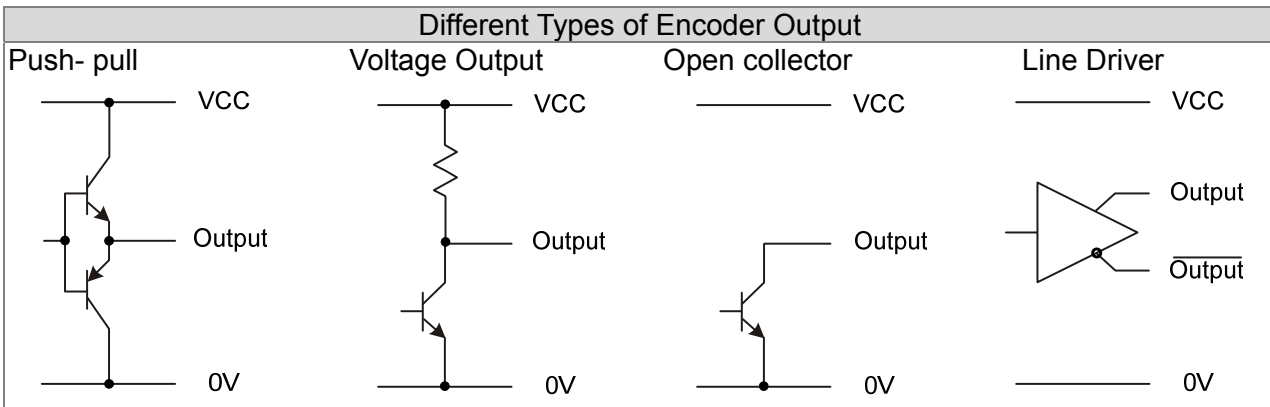

NOTE

- Verify if the SW1 is set to the correct output voltage before power on.
- Keep away from any high voltage line when wiring the motor drive to avoid interference

Wiring Diagram

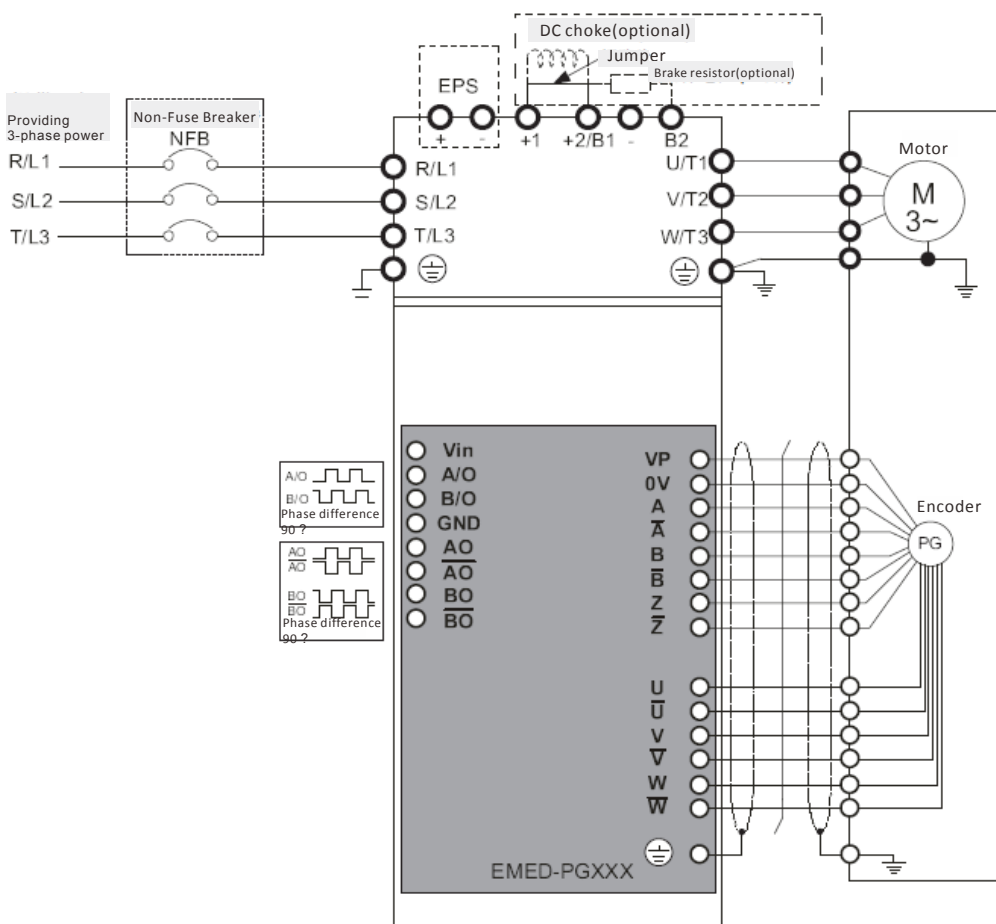

Set up the Signal of the Frequency Division

- ① After the encoder input a PULSE signal, there will be an output signal of the division factor “n.” Use Pr10-29 <Output of PG card’s frequency division> to set up.
- ② Setup of Pr10-29 <PG card’s frequency division>:
Output of decimal frequency division setting. Range of the division factor “n”: 1~31.
- ③ Pr10-30 <Mode of output of PG card’s frequency division>

| Bit3 | Bit2 | Bit1 | Bit0 |
|------|------|-------|------|
| X | X | OUT/M | IN/M |

OUT/M: Mode of pulse output of frequency division;

IN/M: Mode of pulse input of frequency division;

“X” is for backup while “0” is a value to write.

Setting and Description of Input Mode (IN/M) & Output Mode (OUT/M):

| OUT/M | IN/M | Division factor | |
|-------|------|-----------------|-----------------|
| | | A is ahead of B | B is ahead of A |
| 0 | 0 | | |
| 1 | 0 | | |
| X | 1 | | |

NOTE

- In the waveform A-/A, B-/B are the PG card input signals; AO- \overline{AO} , BO- \overline{BO} are the differential output frequency division signals. (Use a differential probe to measure.)
- Division factor “n”: Set 15 to have the input signal divided by 15.)
- When OUT/M, IN/M set as 0.0, the PG card input signal A-/A, B-/B are square waves while AO- \overline{AO} , BO- \overline{BO} are frequency division output.
- When OUT/M, IN/M are set as 1.0, the PG card input signal A-/A, B-/B are square waves while the BO- \overline{BO} is the phase indicator of A and B
- When OUT/M, IN/M are set as X, B-/B phase has to be direction indication input signal (e.g. When B-/B is LOW, it means A is ahead of B. When B-/B is HIGH, it means B is ahead of A)
- Take Pr10-29 and Pr10-30 as examples. When frequency division value =15, OUT/M =1, IN/M = 0, set Pr10-29 = 15 and Pr10-30 = 0002h.
Set Pr100-29 =15,
Set Pr10-30 =0002h

| Bit3 | Bit2 | Bit1 | Bit0 |
|------|------|------|------|
| X | X | 1 | 0 |

7-2 EMED-PGHSD-1

Applicable encoder:

Sine-wave: Heidenhain ERN1387

EnDat2.1: Heidenhain EQN425, EQN1325, ECN113, ECN413, ECN1113, ECN1313

SICK HIPERFACE: SRS50/60

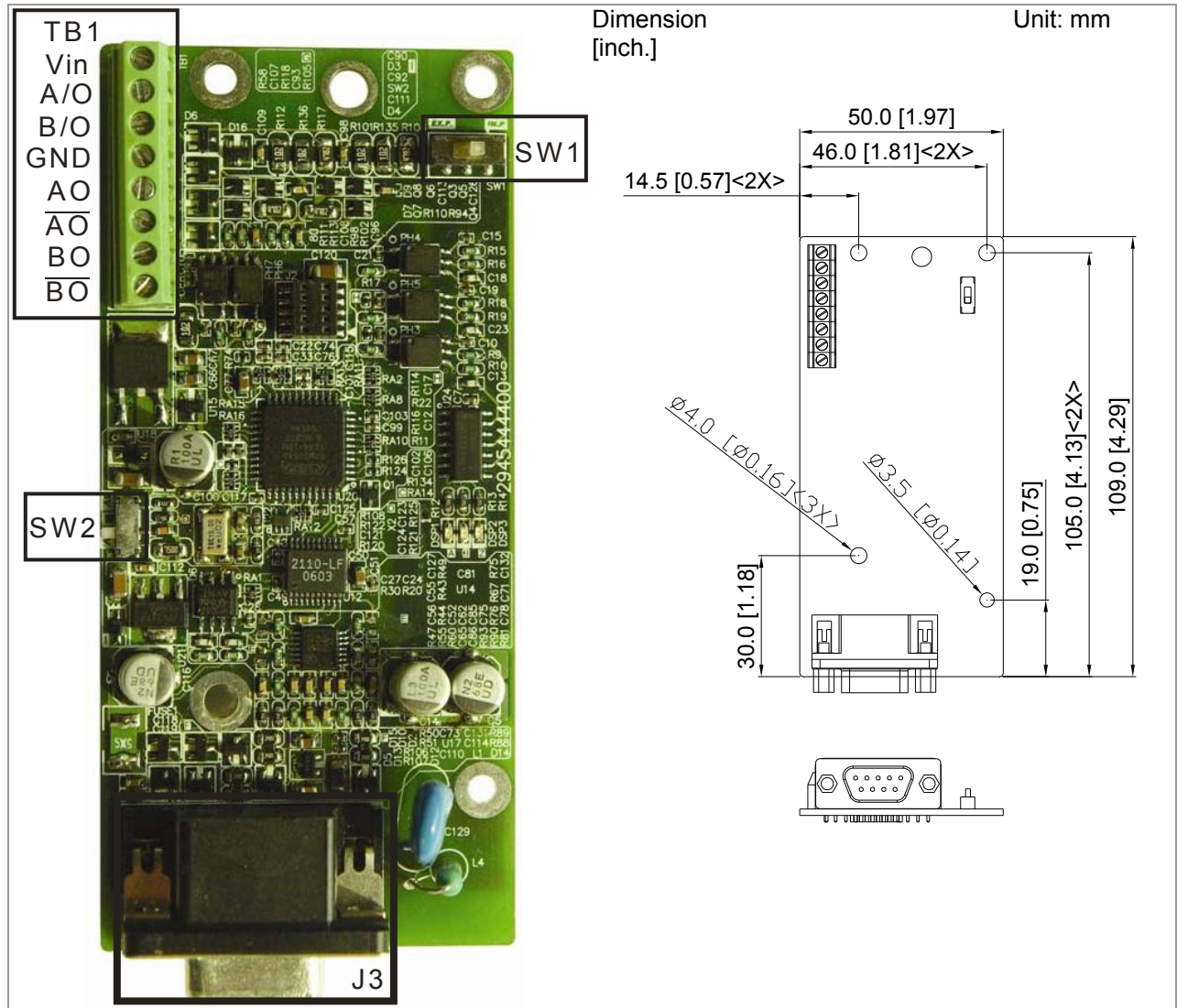

※ Support Heidenhain ERN1387, EnDat2.1, HIPERFACE

| Terminals | | Descriptions |
|-----------------------------|------------------|-------------------------------------------------------------------------------------------------------------------------------------------------------------------------------------|
| TB1 | Vin | Voltage Input: (to adjust output voltage amplitude of the push-pull pulse) Max. input voltage: 24VDC Max. input current: 30mA |
| | GND | Common power input/ signal output terminal |
| | A/O, B/O | Push-Pull Voltage Output Max. output frequency: 50kHz |
| | AO, /AO, BO, /BO | Line Driver RS422 Max. input frequency: 100kHz |
| J3 (D-SUB female connector) | | Encoder signal input terminal |
| SW1 | | Frequency divider output power terminal selection INP: Power supplied by PG card EXP: Power from an external source |
| SW2 | | Encoder's voltage output terminal (UP) NOTE: The output voltage of the terminal SW2 can be modified by simply switching the direction of the dip switch. 5V: 5Vdc 8V: 8Vdc |

EMED-PGHSD-1(Terminal J3) pin definition correspond to each ENCODER type

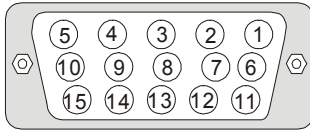

| Terminal# | Heidenhain ERN1387 | Heidenhain ECN1313 | HIPERFACE® |
|-----------|--------------------|--------------------|------------|
| 1 | B- | B- | REFSIN |
| 2 | - | - | - |
| 3 | R+ | DATA | DATA+ |
| 4 | R- | /DATA | DATA- |
| 5 | A+ | A+ | +COS |
| 6 | A- | A- | REFCOS |
| 7 | 0V | 0V | GND |
| 8 | B+ | B+ | +SIN |
| 9 | UP | UP | UP |
| 10 | C- | - | - |
| 11 | C+ | - | - |
| 12 | D+ | - | - |
| 13 | D- | - | - |
| 14 | - | /CLOCK | - |
| 15 | - | CLOCK | - |

Terminal Function:

| Terminals | Descriptions | Specifications |
|----------------------------|--------------------------------------------------------------------------------------------------------------|------------------------------------------------------------------------------------------------------------------------------|
| UP(VP) | The output voltage used by the encoder. Use the dip switch on SW2 to change the output voltage to +5V or +8V | Voltage: +5.1Vdc±0.3V; +8.4Vdc±1.5V Current: 200mA max. |
| 0V | Encoder common power terminal | Reference level of encoder's power. |
| A+, A-, B+, B-, R+, R- | Encoder sine wave differential signal input (Incremental signal) | Input frequency: 40k Hz max. 0.8...1.2Vss (≈1Vss; Z ₀ =120Ω) 0.2V...0.85V (≈0.5V; Z ₀ =120Ω) |
| +SIN, +COS, REFSIN, REFCOS | Encoder sine wave differential signal input | Input frequency: 20k Hz max. 0.9...1.1V REFSIN/REFCOS |
| C+, C-, D+, D- | Encoder sine wave differential signal input (Absolute signal) | 0.8...1.2Vss (≈1Vss; Z ₀ =1kΩ) |
| DATA+(DATA), DATA-(/DATA) | RS485 communication interface | Terminal resistance is about 130Ω |

| | | | |
|--|------------|--------------------------------------|--------------------------------|
| | CLK+, CLK- | CLOCK differential output for ENDAT. | Line Driver RS422 Level output |
|--|------------|--------------------------------------|--------------------------------|

Set up the Signal of the Frequency Division

- ① After the encoder input a PULSE signal, there will be an output signal of the division factor "n." Use Pr10-29 <Output of PG card's frequency division> to set up.
- ② Pr10-29 <Mode of output of PG card's frequency division> :
Output of decimal frequency division setting. Range of the division factor "n": 1~31.

Setting and Description of Input Mode (IN/M) & Output Mode (OUT/M):

| OUT/M | IN/M | Division factor | |
|-------|------|-----------------|-----------------|
| | | A is ahead of B | B is ahead of A |
| 0 | 0 | | |
| 1 | 0 | | |
| X | 1 | | |

NOTE

- In the waveform A-/A, B-/B are the PG card input signals; AO- \overline{AO} , BO- \overline{BO} are the differential output frequency division signals. (Use a differential probe to measure.)
- Division factor "n": Set 15 to have the input signal divided by 15.)
- When OUT/M, IN/M set as 0.0, the PG card input signal A-/A, B-/B are square waves while AO- \overline{AO} , BO- \overline{BO} are frequency division output.
- When OUT/M, IN/M are set as 1.0, the PG card input signal A-/A, B-/B are square waves while the BO- \overline{BO} is the phase indicator of A and B.
- When OUT/M, IN/M are set as X, B-/B phase has to be direction indication input signal (e.g. When B-/B is LOW, it means A is ahead of B. When B-/B is HIGH, it means B is ahead of A)
- Take Pr10-29 and Pr10-30 as examples. When frequency division value = 15, OUT/M = 1, IN/M = 0, set Pr10-29 = 15 and Pr10-30 = 0002h.
Set Pr100-29 = 15,
Set Pr10-30 = 0002h

| | | | |
|------|------|------|------|
| Bit3 | Bit2 | Bit1 | Bit0 |
| X | X | 1 | 0 |

7-3 EMED-PGHSD-2

Applicable encoder:

Sine-wave: Heidenhain ERN1387

EnDat2.1: Heidenhain EQN425, EQN1325, ECN113, ECN413, ECN1113, ECN1313

SICK HIPERFACE: SRS50/60

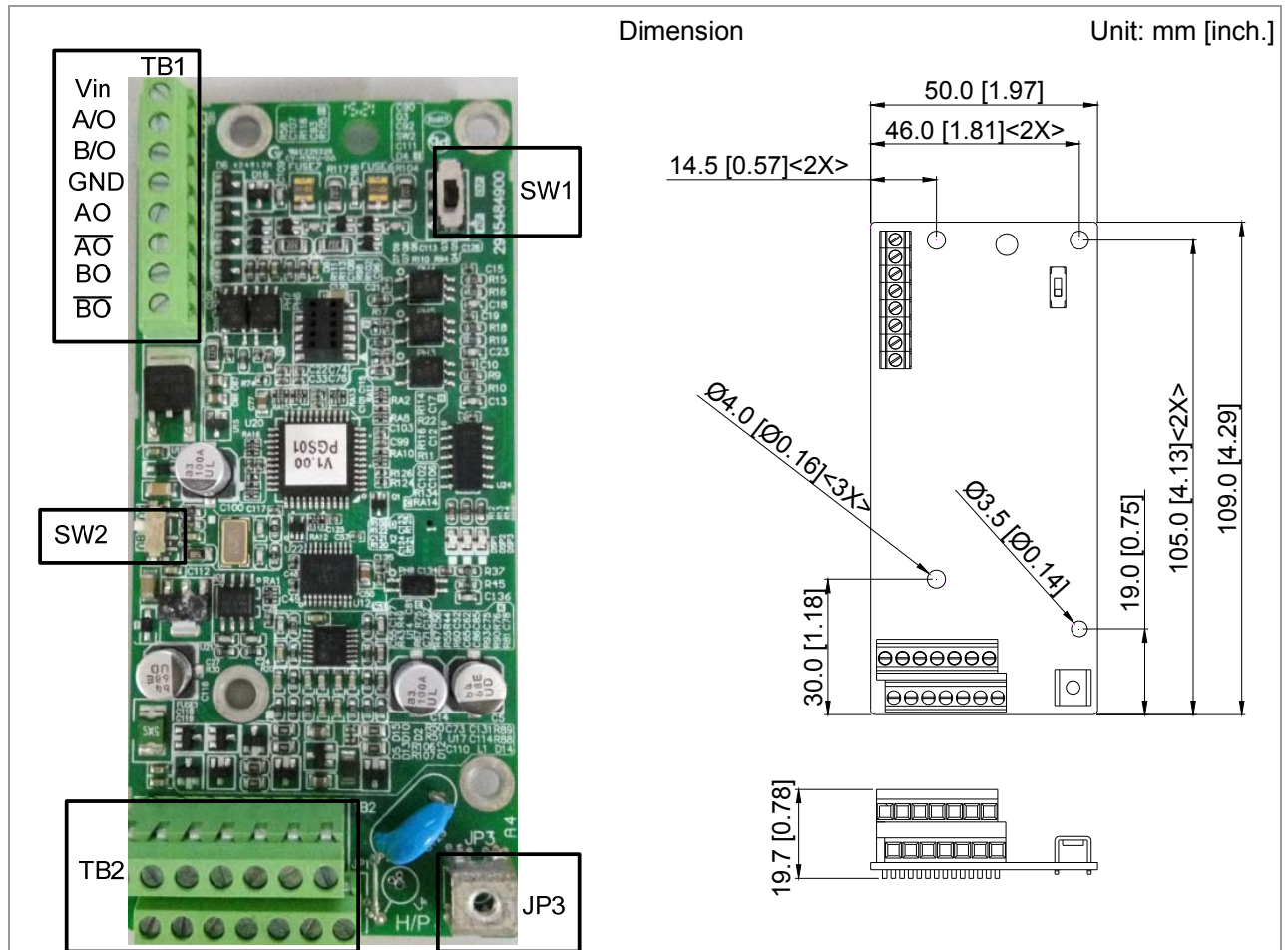

※ SupportHeidenhain ERN1387, EnDat2.1, HIPERFACE

| Terminals | | Descriptions |
|-----------|------------------|-------------------------------------------------------------------------------------------------------------------------------------------------------------------------------------|
| TB1 | Vin | Voltage Input: (to adjust output voltage amplitude of the push-pull pulse) Max. input voltage: 24VDC Max. input current: 30mA |
| | GND | Common power input/ signal output terminal |
| | A/O, B/O | Push-Pull Voltage Output Max. output frequency: 50kHz |
| | AO, /AO, BO, /BO | Line Driver RS422 Max. input frequency 100kHz |
| TB2 | | Encoder signal input terminal |
| JP3 | | Ground Terminal Connect the power supply of the motor drive to the ground. Support PG shielding |
| SW1 | | Frequency divider output power terminal selection INP: Power supplied by PG card EXP: Power from an external source |
| SW2 | | Encoder's voltage output terminal (UP) NOTE: The output voltage of the terminal SW2 can be modified by simply switching the direction of the dip switch. 5V: 5Vdc 8V: 8Vdc |

EMED-PGHSD-2(Terminal TB2) pin definition corresponds to each ENCODER type.

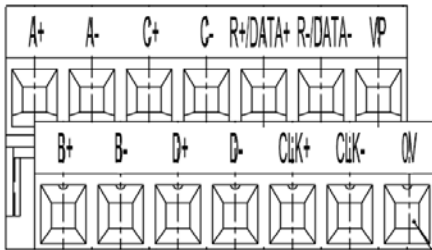

| Terminals | Heidenhain ERN1387 | Heidenhain ECN1313 | HIPERFACE® |
|-----------|--------------------|--------------------|------------|
| B- | B- | B- | REFSIN |
| | - | - | - |
| R+/DATA+ | R+ | DATA | DATA+ |
| R-/DATA- | R- | /DATA | DATA- |
| A+ | A+ | A+ | +COS |
| A- | A- | A- | REFCOS |
| 0V | 0V | 0V | GND |
| B+ | B+ | B+ | +SIN |
| VP | UP | UP | UP |
| C- | C- | - | - |
| C+ | C+ | - | - |
| D+ | D+ | - | - |
| D- | D- | - | - |
| CLK- | - | /CLOCK | - |
| CLK+ | - | CLOCK | - |

Terminal Function

| Terminals | Descriptions | Specifications |
|------------------------------|--------------------------------------------------------------------------------------------------------------|------------------------------------------------------------------------------------------------------------|
| UP(VP) | The output voltage used by the encoder. Use the dip switch on SW2 to change the output voltage to +5V or +8V | Voltage: +5.1Vdc±0.3V; +8.4Vdc±1.5V Current: 200mA max. |
| 0V | Encoder common power terminal | Reference level of encoder's power. |
| A+, A-, B+, B-, R+, R- | Encoder sine wave differential signal input (Incremental signal) | Input frtequency: 40k Hz max 0.8...1.2V _{ss} (≈1V _{ss} ; Z ₀ =120Ω) |
| +SIN, +COS REFSIN, REFCOS | Encoder sine wave differential signal input (Incremental signal) | Input frequency: 20k Hz max. 0.9...1.1V REFSIN/REFCOS |
| C+, C-, D+, D- | Encoder sine wave differential signal input (Absolute signal) | 0.8...1.2V _{ss} (≈1V _{ss} ; Z ₀ =1kΩ) |

| | | |
|---------------------------|-------------------------------------|-----------------------------------|
| DATA+(DATA), DATA-(/DATA) | RS485 communication interface | Terminal resistance is about 130Ω |
| CLOCK, /CLOCK | CLOCK differential output for ENDAT | Line Driver RS422 Level output |

NOTE

- Verify if the SW1 is set to the correct output voltage before power on.
- Keep away from any high voltage line when wiring the motor drive to avoid interference.

Wiring Diagram

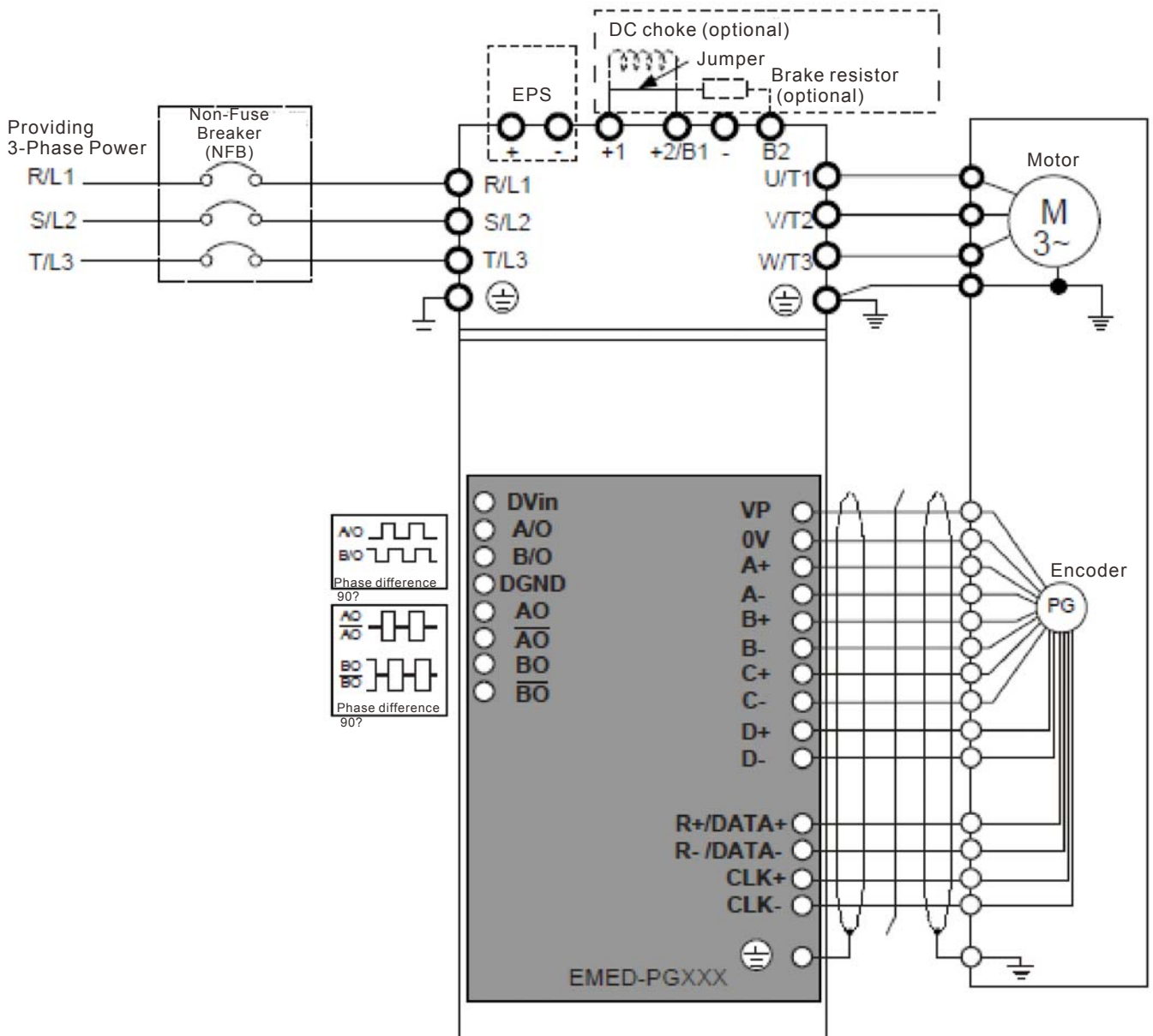

Set up the Signal of the Frequency Division

- ① After the encoder input a PULSE signal, there will be an output signal of the division factor "n." Use Pr10-29 <Output of PG card's frequency division> to set up.
- ② Setup of Pr10-29 <PG card's frequency division>: Output of decimal frequency division setting. Range of the division factor "n": 1~31.

08 Specifications

230V Series

| Frame Size | | B | | | C | | | D | | | E | |
|------------------|----------------------------------------|---------------------------------------|------|---------|-------|------|------|------|------|------|--------|-------|
| Model VFD-__ | ED23/21S | 022* | 037* | 040 | 055 | 075 | 110 | 150 | 185 | 220 | 300 | 370 |
| Applicable Motor | Output(KW) | 2.2 | 3.7 | 4.0 | 5.5 | 7.5 | 11 | 15 | 18.5 | 22 | 30 | 37 |
| Applicable Motor | Output (HP) | 3 | 5 | 5 | 7.5 | 10 | 15 | 20 | 25 | 30 | 40 | 50 |
| Output Rating | Rated Output Capacity(KVA) | 4.8 | 6.8 | 7.9 | 9.5 | 12.5 | 19 | 25 | 29 | 34 | 46 | 55 |
| | Rated Output Current (A) | 12.0 | 17 | 20.0 | 24.0 | 30.0 | 45.0 | 58.0 | 77.0 | 87.0 | 132.0 | 161.0 |
| | Maximum Output Voltage (V) | 3-phase Proportional to Input Voltage | | | | | | | | | | |
| | Output Frequency | 0.00~400Hz | | | | | | | | | | |
| | Carrier Frequency | 2~15kHz | | | | | | | | | 2~9kHz | |
| | Rated Output Maximum Carrier Frequency | 8kHz | | | 10kHz | | | 8kHz | | | 6kHz | |
| Input Rating | Input Current(A) | 24 | 34 | 20 | 23 | 30 | 47 | 56 | 73 | 90 | 132 | 161 |
| | Rated Voltage /Frequency | 1-phase | | 3-phase | | | | | | | | |
| | Voltage Tolerance | 200~240V 50/60Hz | | | | | | | | | | |
| | Frequency Tolerance | ±10% (180~264V) | | | | | | | | | | |
| Cooling Method | Fan cooled | | | | | | | | | | | |
| Weight (kg) | 6 | 6 | 6 | 8 | 10 | 10 | 13 | 13 | 13 | 13 | 36 | 36 |



*VFD022ED21S & VFD037ED21S are 1-phase input models.

460V Series

| Frame Size | | B | C | | | | D | | | E | | | |
|----------------------------|----------------------------------------|---------------------------------------|-------|------|------|------|------|------|---------|------|---------|------|-------|
| Model VFD-__ | ED43S | 040 | 055 | 075 | 110 | 150 | 185 | 220 | 300 | 370 | 450 | 550 | 750 |
| Applicable Motor Power(KW) | | 4.0 | 5.5 | 7.5 | 11 | 15 | 18.5 | 22 | 30 | 37 | 45 | 55 | 75 |
| Applicable Motor power(HP) | | 5 | 7.5 | 10 | 15 | 20 | 25 | 30 | 40 | 50 | 60 | 75 | 100 |
| Output Rating | Rated Output Capacity (KVA) | 9.2 | 10.4 | 13.5 | 18.3 | 24 | 30.3 | 36 | 46.2 | 63.7 | 80 | 96.4 | 116.3 |
| | Rated Output Current (A) | 11.5 | 13 | 17 | 23 | 30 | 38 | 45 | 58 | 80 | 100 | 128 | 165 |
| | Maximum Output Voltage(V) | 3-phase Proportional to Input Voltage | | | | | | | | | | | |
| | Output Frequency | 0.00~400Hz | | | | | | | | | | | |
| | Carrier Frequency | 2~ 15kHz | | | | | | | 2~ 9kHz | | 2~ 6kHz | | |
| | Rated Output Maximum Carrier Frequency | 8kHz | 10kHz | | | 8kHz | | | 6kHz | | | | |
| Input Rating | Rated Input Current(A) | 11.5 | 14 | 17 | 24 | 30 | 37 | 47 | 58 | 80 | 100 | 128 | 165 |
| | Rated voltage | 3-phase 380~480V · 50/60Hz | | | | | | | | | | | |
| | Voltage Tolerance | ±10% (342~528V) | | | | | | | | | | | |
| | Frequency Tolerance | ±5% (47~63Hz) | | | | | | | | | | | |
| Cooling Method | Fan cooled | | | | | | | | | | | | |
| Weight (kg) | 6 | 8 | 10 | 10 | 10 | 10 | 13 | 14.5 | 36 | 36 | 50 | 50 | |

*Assumes operation at the rated output. Input current rating varies depending on the power supply, input reactor, wiring connections and power supply impedance.

General Specifications

| | | |
|---------------------------------------------|----------------------------------------------------------------------------------------------------------------------------------------------------------------------------------------------------------------------------------------------|-------------------------------------------------------------------------------------------------------------|
| Control Characteristics | Control Method | 1: V/F, 2: VF+PG, 3: SVC, 4: FOC+PG, 5: TQC+PG, 6:FOC+PM |
| | Starting Torque | Reach up to 150% or above at 0.5 Hz Under FOC+PG or FOC+PM mode, starting torque can reach 150% at 0 Hz. |
| | Speed Control Range | 1:100 (up to 1:1000 when using PG card) |
| | Speed Control Resolution | ±0.5% (up to ±0.02% when using PG card) |
| | Speed Response Ability | 5Hz (Up to 30Hz for vector control) |
| | Max. Output Frequency | 0.00 to 400Hz |
| | Output Frequency Accuracy | Digital Command 0.005%, Analog Command 0.5% |
| | Frequency Setting Resolution | Digital Command 0.01Hz, Analog Command: 1/4096(12 bit) of the max. output frequency. |
| | Torque limit | Max. is 200% torque current |
| | Torque Accuracy | ±5% |
| | Accel. / Decel. Time | 0.00~600.00 seconds |
| | V/F Curve | Adjustable V/f curve using 4 independent points and square curve. |
| | Frequency Setting Signal | ±10V |
| | Brake Torque | About 20% |
| | Protection Characteristics | Motor Protection |
| Over-current Protection | | The current forces 190% of the over-current protection and 250% of the rated current. |
| Ground Leakage Current Protection | | Higher than 50% rated current |
| Overload Ability | | Constant torque: 150% for 60 seconds, variable torque: 190% for 5 seconds |
| Over-voltage Protection | | Over-voltage level: Vdc > 400/800V; low-voltage level: Vdc < 200/400V |
| Over-voltage Protection for the Input Power | | Varistor (MOV) |
| Over-temperature Protection | | Built-in temperature sensor |
| Certifications |   (UL mark excludes VFD022ED21S and VFD037ED21S) EN81-1+A3, EN81-20 | |

Environment for Operation, Storage and Transportation

DO NOT expose the AC motor drive in a bad environment, such as dust, direct sunlight, corrosive/inflammable gasses, humidity, liquid and vibration environment. The salt in the air must be less than 0.01mg/cm² every year.

| | | | | |
|------------------|--------------------------------------------------------------------------------------------------------------------------------------------------------------------------------------------------------------------------------|---------------------------------------------------------------------------------------------------------------------------------------------------------------------------------------------------------------------------------------------------------------------------------------------------------------------------------------------------------------------------------------|---------------------------------------------------------------------------|------------------------------------------------------------------------------|
| Environment | Installation location | IEC60364-1/IEC60664-1 Pollution degree 2, Indoor use only | | |
| | Surrounding Temperature | Operation | Between 10°C ~40°C with Derating the operation temperature can reach 50°C | |
| | | | Between 40°C ~50°C with Derating | 2.2-4kW: for every 1°C raise in temperature, decrease 2.2% of rated current |
| | | | | 5.5-30kW: for every 1°C raise in temperature, decrease 2.5% of rated current |
| | | | | 37-75kW: for every 1°C raise in temperature, decrease 2.0% of rated current |
| | | Storage and Transportation | -20 °C ~ +60 °C | |
| | | Non-condensation, non-frozen | | |
| | Rated Humidity | Operation | Max. 90% | |
| | | Storage/ Transportation | Max. 90% | |
| | | No condense water | | |
| Altitude | Operation | If AC motor drive is installed at altitude 0~1000m, follow normal operation restriction. If it is install at altitude 1000~3000m, decrease 1% of rated current or lower 0.5°C of temperature for every 100m increase in altitude. Maximum altitude for Corner Grounded is 3000m. If an installation at an altitude higher than 3000m is required, contact Delta for more information. | | |
| Power System | TN system ^{*1*2} | | | |
| Package Drop | Storage | ISTA procedure 1A (according to weight) IEC60068-2-31 | | |
| | Transportation | | | |
| Vibration | <ul style="list-style-type: none"> ● 1.0mm, peak to peak value range from 2Hz to 13.2 Hz; ● 0.7G~1.0G range from 13.2Hz to 55Hz; ● 1.0G range from 55Hz to 512 Hz. Comply with IEC 60068-2-27 | | | |
| Impact | IEC/EN 60068-2-27 | | | |
| Protection Level | NEMA 1/IP20 | | | |

*1: TN system: The neutral point of the power system connects to the ground directly. The exposed metal components connect to the ground via the protective earth conductor.

*2: Single phase models use single phase three wire power system.





09 Digital Keypad

9-1 Description of Digital Keypad



Digital Operation Panel KPED-LE01











Function of Buttons

| Buttons | Description |
|-------------------------------------------------------------------------------------|-----------------------------------------------------------------------------------------------------------------------------------------------------------------------------------------------------------------------------------------------------|
|  | Horizontal movement button: To move the cursor position for value adjustment. |
|  | Reset the the motor drive after fault occurred. |
|  | Change between different diplay mode. |
|  | Parameter setting button: To read or modify various parameter settings. |
|  | <ol style="list-style-type: none"> Two buttons available: Up and Down button Press Up or Down button to increase or decrease the value of a number. Press Up or Down button to choose between menus and languages. |

LED Display

| LED | Description |
|-------------------------------------------------------------------------------------|-------------------------------------------------------------------------------------------------------------------------------------|
|  | Status Display: UP: Moving up. DN: Moving down D1: MI1 status D2: MI2 status D3: MI3 status D4: MI4 status |
|  | Main Display Area: To display frequency, current, voltage, rotaion direction, user defined units, errors and warnings. |

Description of the Displayed Functions

| Displayed Function | Description |
|-------------------------------------------------------------------------------------|-----------------------------------------------------------------------------------------------------------------------------------------------------------------------------------------------------------------------------------|
|  | Display the frequency setting of the VFD-ED |
|  | Display the actual frequency delivered from VFD-ED to the motor. |
|  | Display the user defined value at Pr00-04. |
|  | Display the current (ampere) |
|  | Display the selected parameter |
|  | Display the value set at a parameter |
|  | Display the external fault |
|  | Display "End" for approximately 1 second if input has been accepted by pressing ENTER key. After a parameter value has been set, the new value is automatically stored in the register. To modify an entry, use the ▲ and ▼ keys. |
|  | If the command given by the user is not accepted or the value of the command exceeds the allowed range, this error message will be displayed. |

9-2 Operating the Built-in Digital Keypad

Setting Mode

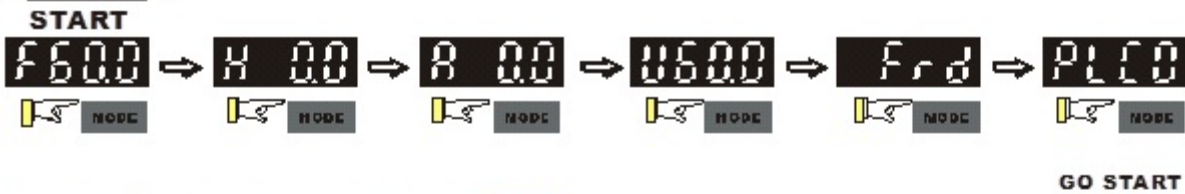

NOTE: In the selected mode, press **ENTER** to set the parameters.

Setting parameters



NOTE :In the parameter setting mode, you can press **ENTER** to the selected mode.

To change data



Setting direction (When operation source is digital keypad)



9-3 Description of the Digital Keypad KPC-CC01

KPC-CC01









Communication Interface
RJ-45 (socket), -485 interface;



Installation Method

1. Embedded type and can be put flat on the surface of the control box. The front cover is water proof.
2. Buy a MKC-KPPK model to do wall mounting or embedded mounting. Its protection level is IP66.
3. The maximum RJ45 extension lead is 5 m (16ft)
4. This keypad can also be used on Delta's motor drive C2000, CH2000 and CP2000.

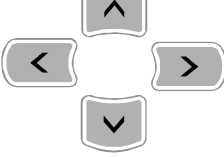
Function of Buttons

| Button | Description |
|-------------------------------------------------------------------------------------|-------------------------------------------------------------------------------------------------------------------------------------------------------------------------------------------------------------------------------------------------------------------------------------------------------------------------------------------------------------------------------------------------------------------------------------------------------------------------------------------------|
|  | <p>Start Operation Key</p> <ol style="list-style-type: none"> 1. It is only valid when the source of operation command is from the keypad. 2. It can operate the AC motor drive by the function setting and the RUN LED will be ON. 3. It can be pressed repeatedly while the motor drive is shutting down.. |
|  | <p>Stop Command Key. This key has the highest processing priority in any situation.</p> <ol style="list-style-type: none"> 1. When it receives STOP command, no matter the AC motor drive is in operation or stop status, the AC motor drive needs to execute "STOP" command. 2. The RESET key can be used to reset the drive after the fault occurs. For those faults that can't be reset by the RESET key, see the fault records after pressing MENU key for details. |
|  | <p>Operation Direction Key</p> <ol style="list-style-type: none"> 1. This key is only control the operation direction NOT for activate the drive. FWD: forward, REV: reverse. 2. Refer to the LED descriptions for more details. |
|  | <p>ENTER Key Press ENTER and go to the next level. If it is the last level then press ENTER to execute the command</p> |
|  | <p>ESCAPE Key ESC key function is to leave current menu and return to the last menu. It is also functioned as a return key in the sub-menu.</p> |
|  | <p>Press menu to return to main menu.</p> |
|  | <p>Direction: Left/Right/Up/Down</p> <ol style="list-style-type: none"> 1. In the numeric value setting mode, it is used to move the cursor and change the numeric value. 2. In the menu/text selection mode, it is used for item selection. |

Description of LED Functions

| LED | Description |
|-----------------------------------------------------------------------------------|-------------------------------------------------------------------------------------------------------------------------------------------------------------------------------------------------------------------------------------------------------------------------------------------|
|  | <p>Steady ON: operation indicator of the AC motor drive, including DC brake, zero speed, standby, restart after fault and speed search.</p> <p>Blinking: drive is decelerating to stop or in the status of base block.</p> <p>Steady OFF: drive doesn't execute the operation command</p> |
|  | <p>Steady ON: stop indicator of the AC motor drive.</p> <p>Blinking: drive is in the standby status.</p> <p>Steady OFF: drive doesn't execute "STOP" command.</p> |
|  | <p>Operation Direction LED</p> <ol style="list-style-type: none"> 1. Green light is on, the drive is running forward. 2. Red light is on, the drive is running backward. 3. Twinkling light: the drive is changing direction. |

9-4 Function of Digital Keypad KPC-CC01

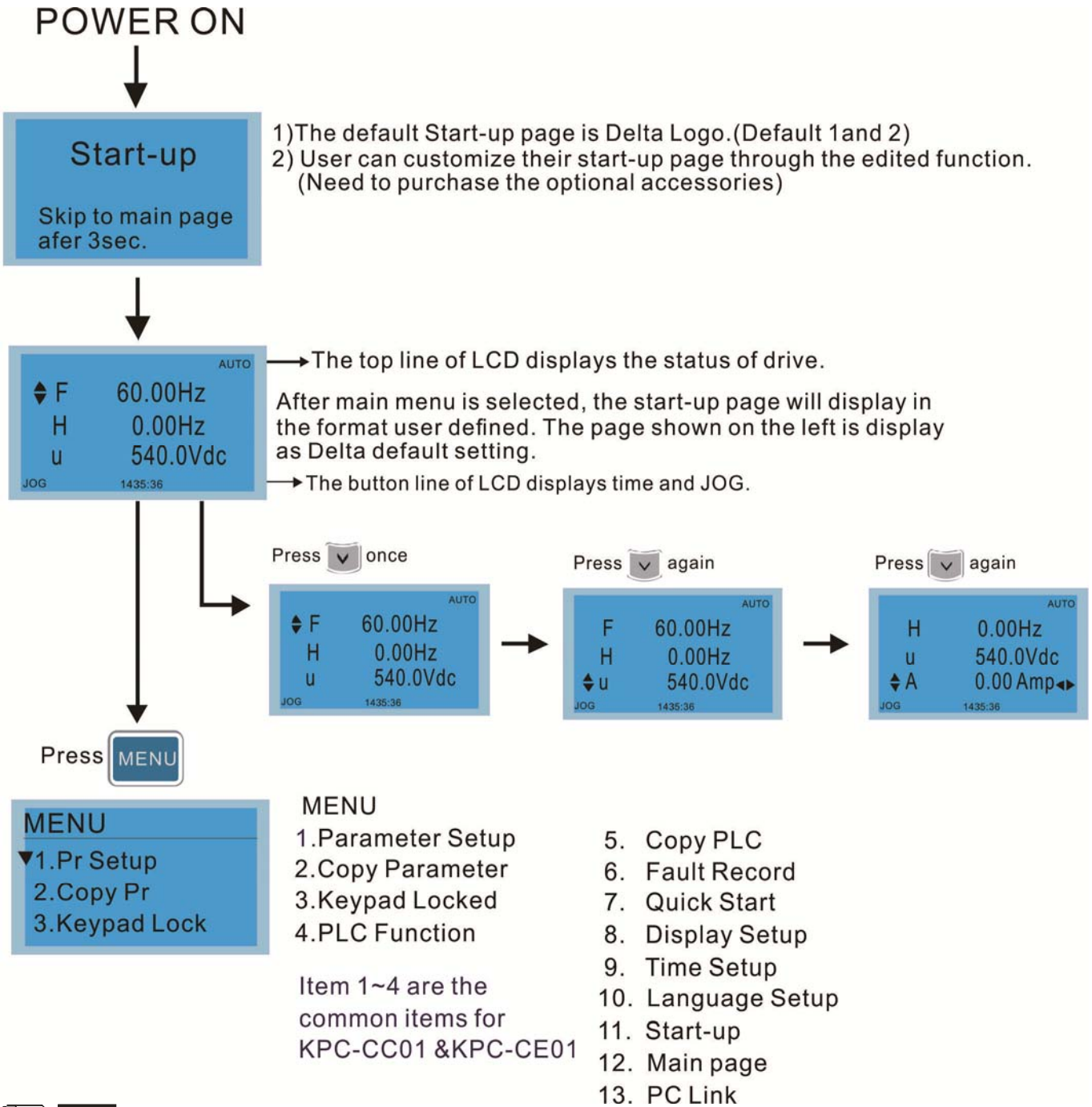

NOTE

1. Start-up page can only display pictures, no flash.
2. When Power ON, it will display startup page then the main page. The main page displays Delta's default setting F/H/A/U, the display order can be set by Pr.00.03 (Startup display). When the selected item is U page, use left key and right key to switch between the items, the display order of U page is set by Pr.00.04 (User display).
3. **VFD-ED doesn't support Function 3, 4 and 5.**

Display Icon

Start-up

◆ 1.Default 1 ●

2.Default 2

3.User define

● : present setting

◆ : roll down the page for more options

Press for more options.

Pr setup

◆ 00:SYSTEM PARAM

01:BASIC PARAM

02:DIGITAL IN/ ▶

▶ : show complete sentence

Press for complete information

Display Item

MENU

◆ 1.Pr Setup

2.Copy Pr

3.Keypad Lock

MENU

1.Parameter Setup

2.Copy Parameter

3.Keypad Locked

4.PLC Function

5. Copy PLC

6. Fault Record

7. Quick Start

8. Display Setup

9. Time Setup

10. Language Setup

11. Start-up

12. Main page

13. PC Link

Item 1~4 are the common items for KPC-CC01 &KPC-CE01

1. Parameter Setup

| | |
|----------------------------------------------------------------------------------------------------------------------------------------------------------------------------------------------------------------------------------------------------------------------------------------------------------------------|----------------------------------------------------------------------------------------------------------------------------------------------------------------------------------------------------------------------------------------------------------------------------------------------------------------------------------------------------------------------------------------------------------------------------------------------------------------------------------------------------------------------------------------------------------------------------------------------------------------------------------------------------------------------------------------------------------------------------------------------------------------------------------------------------------------------------------------------------------------------------------------------------------------------------------------------------------------------------------------------------------------------------------------------------------------------------------------------------------------------------------------------------------------------------------------------|
| <div style="border: 1px solid black; padding: 5px; margin-bottom: 10px;"> <p>Pr setup</p> <p>◆ 00:SYSTEM PARAM</p> <p>01:BASIC PARAM</p> <p>02:DIGITAL IN/ ▶</p> </div> <p>Press to select.</p> <p>Press to select a parameter group.</p> <p>Once a parameter group is selected, press to go into that group.</p> | <p>For example: Setup source of master frequency command.</p> <div style="border: 1px solid black; padding: 5px; margin-bottom: 5px;"> <p>00- SYSTEM PARAME</p> <p>◆ 00: Identity Co ▶</p> <p>01: Rated Curren</p> <p>02: Parameter Re</p> </div> <p>Once in the Group 00 Motor Drive Parameter, Use Up/Down key to select parameter 20: Auto Frequency Command.</p> <div style="border: 1px solid black; padding: 5px; margin-bottom: 5px;"> <p>00- SYSTEM PARAME</p> <p>◆ 20: Source of F ▶</p> <p>21: Source of OP</p> <p>22: Stop Methods</p> </div> <p>When this parameter is selected, press ENTER key to go to this parameter's setting menu.</p> <div style="border: 1px solid black; padding: 5px; margin-bottom: 5px;"> <p>00-20</p> <p style="text-align: center;">2</p> <p>Analog Input</p> <p>0~8 ADD</p> </div> <p>Use Up/Down key to choose a setting. For example: Choose "2 Analogue Input, then press the ENTER key.</p> <div style="border: 1px solid black; padding: 5px;"> <p>00-20</p> <p style="text-align: center;">END</p> <p>Analog Input</p> </div> <p>After pressing the ENTER key, an END will be displayed which means that the parameter setting is done.</p> |
|----------------------------------------------------------------------------------------------------------------------------------------------------------------------------------------------------------------------------------------------------------------------------------------------------------------------|----------------------------------------------------------------------------------------------------------------------------------------------------------------------------------------------------------------------------------------------------------------------------------------------------------------------------------------------------------------------------------------------------------------------------------------------------------------------------------------------------------------------------------------------------------------------------------------------------------------------------------------------------------------------------------------------------------------------------------------------------------------------------------------------------------------------------------------------------------------------------------------------------------------------------------------------------------------------------------------------------------------------------------------------------------------------------------------------------------------------------------------------------------------------------------------------|

2. Copy Parameter

| | | | | | |
|--------------------------------------------------------------|--------------------------------------------------------------------------------------------------------------------------------------------------------------------------------------------------------------------------------------------------------------------------------------------------------------------------------------------------------------------------------------------------------------------------------------------|--|------------------------------------------------------------------------------------------------------------------------------------------------------------------------------|--|---------------------------------------------------------------------------------------------------------------|
| | <p>4 duplicates are provided The steps are shown in the example below. Example: Saved in the motor drive.</p> | | | | |
| <p>Press ENTER key to go to 001~004: content storage</p> | <table border="1"> <tr> <td data-bbox="719 264 935 389"> </td> <td data-bbox="954 264 1492 383"> <p>1 Go to Copy Parameter 2 Select the parameter group which needs to be copied and press ENTER key.</p> </td> </tr> <tr> <td data-bbox="719 398 935 510"> </td> <td data-bbox="954 412 1500 510"> <p>1 Select 1: Save in the motor drive. 2. Press ENTER key to go to "Save in the motor drive" screen.</p> </td> </tr> </table> | | <p>1 Go to Copy Parameter 2 Select the parameter group which needs to be copied and press ENTER key.</p> | | <p>1 Select 1: Save in the motor drive. 2. Press ENTER key to go to "Save in the motor drive" screen.</p> |
| | <p>1 Go to Copy Parameter 2 Select the parameter group which needs to be copied and press ENTER key.</p> | | | | |
| | <p>1 Select 1: Save in the motor drive. 2. Press ENTER key to go to "Save in the motor drive" screen.</p> | | | | |
| | <table border="1"> <tr> <td data-bbox="719 533 935 651"> </td> <td data-bbox="954 591 1444 622"> <p>Begin to copy parameters until it is done.</p> </td> </tr> </table> | | <p>Begin to copy parameters until it is done.</p> | | |
| | <p>Begin to copy parameters until it is done.</p> | | | | |
| | <table border="1"> <tr> <td data-bbox="719 667 935 763"> </td> <td data-bbox="954 689 1500 750"> <p>Once copying parameters is done, keypad will automatically be back to this screen.</p> </td> </tr> </table> | | <p>Once copying parameters is done, keypad will automatically be back to this screen.</p> | | |
| | <p>Once copying parameters is done, keypad will automatically be back to this screen.</p> | | | | |
| | <p>Example: Saved in the keypad.</p> | | | | |
| | <table border="1"> <tr> <td data-bbox="719 853 935 972"> </td> <td data-bbox="954 853 1500 972"> <p>1. Once copying parameters is done, keypad will automatically be back to this screen. 2. Select the parameter group which needs to be copied and press ENTER key.</p> </td> </tr> </table> | | <p>1. Once copying parameters is done, keypad will automatically be back to this screen. 2. Select the parameter group which needs to be copied and press ENTER key.</p> | | |
| | <p>1. Once copying parameters is done, keypad will automatically be back to this screen. 2. Select the parameter group which needs to be copied and press ENTER key.</p> | | | | |
| | <table border="1"> <tr> <td data-bbox="719 987 935 1106"> </td> <td data-bbox="954 1025 1500 1084"> <p>Press ENTER key to go to "Save in the motor drive" screen.</p> </td> </tr> </table> | | <p>Press ENTER key to go to "Save in the motor drive" screen.</p> | | |
| | <p>Press ENTER key to go to "Save in the motor drive" screen.</p> | | | | |
| | <table border="1"> <tr> <td data-bbox="719 1137 935 1234"> </td> <td data-bbox="954 1160 1500 1234"> <p>Use Up/Down key to select a symbol. Use Left/Right key to move the cursor to select a file name.</p> </td> </tr> </table> | | <p>Use Up/Down key to select a symbol. Use Left/Right key to move the cursor to select a file name.</p> | | |
| | <p>Use Up/Down key to select a symbol. Use Left/Right key to move the cursor to select a file name.</p> | | | | |
| | <p>String & Symbol Table: !"#\$%&'()*+,-./0123456789:;<=>?@ABCDEFGHIJKLMN OPQRSTUVWXYZ [\]^_`abcdefghijklmnopqrstu vwxyz{ }~</p> | | | | |
| | <table border="1"> <tr> <td data-bbox="719 1451 935 1547"> </td> <td data-bbox="954 1487 1500 1547"> <p>Once the file name is confirmed, press ENTER key.</p> </td> </tr> </table> | | <p>Once the file name is confirmed, press ENTER key.</p> | | |
| | <p>Once the file name is confirmed, press ENTER key.</p> | | | | |
| | <table border="1"> <tr> <td data-bbox="719 1585 935 1704"> </td> <td data-bbox="954 1644 1492 1675"> <p>To begin copying parameters until it is done.</p> </td> </tr> </table> | | <p>To begin copying parameters until it is done.</p> | | |
| | <p>To begin copying parameters until it is done.</p> | | | | |
| | <table border="1"> <tr> <td data-bbox="719 1742 935 1839"> </td> <td data-bbox="954 1756 1500 1839"> <p>When copying parameters is completed, keypad will automatically be back to this screen.</p> </td> </tr> </table> | | <p>When copying parameters is completed, keypad will automatically be back to this screen.</p> | | |
| | <p>When copying parameters is completed, keypad will automatically be back to this screen.</p> | | | | |
| | <table border="1"> <tr> <td data-bbox="719 1877 935 1973"> </td> <td data-bbox="954 1912 1500 1973"> <p>Press Right key to see the date of copying parameters.</p> </td> </tr> </table> | | <p>Press Right key to see the date of copying parameters.</p> | | |
| | <p>Press Right key to see the date of copying parameters.</p> | | | | |

| | | |
|--|----------------------------------------------------------------|---------------------------------------------------------------|
| | <p>Copy pr</p> <p>◆ 001:18:38:58 ◀</p> <p>002:</p> <p>003:</p> | <p>Press Right key to see the time of copying parameters.</p> |
|--|----------------------------------------------------------------|---------------------------------------------------------------|

3. Lock the Keypad





| | |
|------------------------------------------------------------------------------------------------------------------------------------------------------------------------------------------------------------------------------------------------------------------------------|---------------------------------------------------------------------------------------------------------------------------------------------------------------------------------------------------------------------------------------------------------------------------------------------------------------------------------------------------------------------------------------------------------------------------------------------------------------------------------------------------------------------------------------------------------------------------------------------------------------------------------------------------------------------------------------------------------------------------------------------------------------------------------------------------------------------------------------------------------------------------------------------------------------------------------------------------------------------------------------------------------------------------------------------------------------------------------------------------------------------------------------------------------------------------------------------------------------------------------------------------------------------------------------------------------------------------------------------------------------------------------------------------------------------------------------------------------------------------------------------------------------------------------------------------------------------------------------------------------------------------------------------------------------------------------------------------------------------------------------------------------------------------------------------------------------------------|
| <div data-bbox="193 208 507 394" style="border: 1px solid black; padding: 5px;"> <p>Keypad Lock</p> <p>Press ENTER to Lock Key</p> </div> <p data-bbox="193 421 507 472">Press  to lock</p> | <p>Keypad Locked</p> <p>This function is used to lock the keypad. The main page would not display “keypad locked” when the keypad is locked, however it will display the message “please press ESC and then ENTER to unlock the keypad” when any key is pressed.</p> <div data-bbox="580 416 794 544" style="border: 1px solid black; padding: 2px;"> <p style="text-align: right;">AUTO</p> <p>◆F 60.00Hz H 0.00Hz u 540.0Vdc JOG 14:35:58</p> </div> <div data-bbox="580 551 794 667" style="border: 1px solid black; padding: 2px;"> <p>Keypad Lock</p> <p>Press ESC 3 sec to UnLock Key</p> </div> <div data-bbox="580 674 794 801" style="border: 1px solid black; padding: 2px;"> <p style="text-align: right;">AUTO</p> <p>◆F 60.00Hz H 0.00Hz u 540.0Vdc JOG 14:35:58</p> </div> <div data-bbox="580 808 794 925" style="border: 1px solid black; padding: 2px;"> <p>Keypad Lock</p> <p>Press ESC 3 sec to UnLock Key</p> </div> <div data-bbox="580 931 794 1059" style="border: 1px solid black; padding: 2px;"> <p style="text-align: right;">AUTO</p> <p>◆F 60.00Hz H 0.00Hz u 540.0Vdc JOG 14:35:58</p> </div> <p>When the keypad is locked, the main screen doesn't display any status to show that.</p> <p>Press any key on the keypad; a screen as shown in image on the left will be displayed.</p> <p>If ESC key is not pressed, the keypad will automatically be back to this screen.</p> <p>The keypad is still locked at this moment. By pressing any key, a screen as shown in the image on the left will still be displayed.</p> <p>Press ESC for 3 seconds to unlock the keypad and the keypad will be back to this screen. Then each key on the keypad is functional.</p> <p>Turn off the power and turn on the power again will not lock keypad.</p> |
|------------------------------------------------------------------------------------------------------------------------------------------------------------------------------------------------------------------------------------------------------------------------------|---------------------------------------------------------------------------------------------------------------------------------------------------------------------------------------------------------------------------------------------------------------------------------------------------------------------------------------------------------------------------------------------------------------------------------------------------------------------------------------------------------------------------------------------------------------------------------------------------------------------------------------------------------------------------------------------------------------------------------------------------------------------------------------------------------------------------------------------------------------------------------------------------------------------------------------------------------------------------------------------------------------------------------------------------------------------------------------------------------------------------------------------------------------------------------------------------------------------------------------------------------------------------------------------------------------------------------------------------------------------------------------------------------------------------------------------------------------------------------------------------------------------------------------------------------------------------------------------------------------------------------------------------------------------------------------------------------------------------------------------------------------------------------------------------------------------------|

4. Fault Record

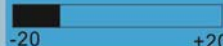
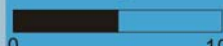

| | |
|-------------------------------------------------------------------------------------------------------------------------------------------------------------------------------------------------------------------------------------------------------------------------------------------------------------------------------------------------------------------------|-----------------------------------------------------------------------------------------------------------------------------------------------------------------------------------------------------------------------------------------------------------------------------------------------------------------------------------------------------------------------------------------------------------------------------------------------------------------------------------------------------------------------------------------------------------------------------------------------------------------------------------------------------------------------------------------------------------------------------------------------------------------------------------------------------------------------------------------------------------------------------------------------------------------------------------------------------------------------------------------------------------------------------------------------------------------------------------------------------------------------------------------------------------------------------------------------------------------------------------------------------------------------------------------------------------------------------------------------------------------------------------------------------------------------------------------------------------------------------------------------------------------------------------------------------------------------------------------------------------------------------------------------------------|
| <div data-bbox="193 1180 507 1366" style="border: 1px solid black; padding: 5px;"> <p>Fault record</p> <p>▼ 1:oL 2:ovd 3:GFF</p> </div> <p data-bbox="193 1393 507 1444">Press  to select.</p> <p data-bbox="193 1471 507 1523">KPC-CE01 does not support this function.</p> | <p>Able to store 6 error code (Keypad V1.02 and previous versions) Able to store 20 error code(Keypad V1.0e3 and previous version) The most recent error record is shown as the first record. Select an error record to see its detail such as date, tme, frequency, current, voltage, DCBUS voltage)</p> <div data-bbox="580 1368 794 1496" style="border: 1px solid black; padding: 2px;"> <p>Fault record</p> <p>▼ 1:oL 2:ovd 3:GFF</p> </div> <div data-bbox="580 1503 794 1630" style="border: 1px solid black; padding: 2px;"> <p>1: oL</p> <p>◆Current: 79.57 Voltage: 189.2 BUS Voltage:409.5</p> </div> <div data-bbox="580 1637 794 1765" style="border: 1px solid black; padding: 2px;"> <p>1: oL</p> <p>◆Date: 01/20/2014 Time: 21:02:24 Outfreq: 32.61</p> </div> <div data-bbox="580 1771 794 1899" style="border: 1px solid black; padding: 2px;"> <p>Fault record</p> <p>1:oL ◆2:ovd 3:GFF</p> </div> <div data-bbox="580 1906 794 2033" style="border: 1px solid black; padding: 2px;"> <p>2: ovd</p> <p>◆Current: 79.57 Voltage: 189.2 BUS Voltage:409.5</p> </div> <p>Press Up/Down key to select an error record. After selecting an error code, press ENTER to see that error record's detail</p> <p>Press Up/Down key to see an error record's detail such as date, time, frequency, current, voltage, DCBus voltage.</p> <p>Press Up/Down key to select an error record. After selecting an error code, press ENTER to see that error record's detail</p> <p>Press Up/Down key to see an error record's detail such as date, time, frequency, current, voltage, DCBus voltage.</p> |
|-------------------------------------------------------------------------------------------------------------------------------------------------------------------------------------------------------------------------------------------------------------------------------------------------------------------------------------------------------------------------|-----------------------------------------------------------------------------------------------------------------------------------------------------------------------------------------------------------------------------------------------------------------------------------------------------------------------------------------------------------------------------------------------------------------------------------------------------------------------------------------------------------------------------------------------------------------------------------------------------------------------------------------------------------------------------------------------------------------------------------------------------------------------------------------------------------------------------------------------------------------------------------------------------------------------------------------------------------------------------------------------------------------------------------------------------------------------------------------------------------------------------------------------------------------------------------------------------------------------------------------------------------------------------------------------------------------------------------------------------------------------------------------------------------------------------------------------------------------------------------------------------------------------------------------------------------------------------------------------------------------------------------------------------------|

| | |
|--|-----------------------------------------------------------------------------------------------------------------------------------------------------------------------------------------------------------------------------------------------------------------------------------------------------------------------------------------------------------------------------------------------------------------------------------------------------------------------------------------------------------------------------------------------------------------------------------------------------------------------------------------------------------------------------------------------|
| | <div style="border: 1px solid black; padding: 5px; margin-bottom: 5px;"> 2: ovd ◆ Date: 01/20/2014 Time: 21:02:24 Outfreq: 32.61 </div> <div style="border: 1px solid black; padding: 5px;">  NOTE Fault actions of AC motor drive are record and save to KPC-CC01. When KPC-CC01 is removed and apply to another AC motor drive, the previous fault records will not be deleted. The new fault records of the present AC motor drive will accumulate to KPC-CC01. </div> |
|--|-----------------------------------------------------------------------------------------------------------------------------------------------------------------------------------------------------------------------------------------------------------------------------------------------------------------------------------------------------------------------------------------------------------------------------------------------------------------------------------------------------------------------------------------------------------------------------------------------------------------------------------------------------------------------------------------------|

5. Display Setup

| | |
|-----------------------------------------------------------------------------------------------------------------------------------------------------------------------------------------------------------------------------------------------------------------------------------------------------------------------------------------|-----------------------------------------------------------------------------------------------------------------------------------------------------------------------------------------------------------------------------------------------------------------------------------------------------------------------------------------------------------------------------------------------------------------------------------------------------------------------------------------------------------------------------------------------------------------------------------------------------------------------------------------------------------------------------------------------------------------------------------------------------------------------------------------------------------------------------------------------------------------------------------------------------------------------------------------------------------------------------------------------------------------------------------------------------------------------------------------------------------------------------------------------------------------------------------------------------------------------------------------------------------------------------------------------------------------------------------------------------------------------------------------------------------------------------------------------------------------------------------------------------------------------------------------------------------------------------------------------------------------------------------------------------------------------------------------------------------------------------------------------------------------------------------------------------------------------------------------------------------------------------------------------------------------------------------------------------------------------------------------------------------------------------------------------------------------------------------------------------------------------------------------------------------------------------------------------------------------------------------------------------------------------------------------------------------------------------------------------------------------------------------------------------------------------------------------------------------------------------------------------------------------------------------------------------------------------------------------------------------------------------------------------------------------------------------------------------------------------------------------------------------------------------------------------------------------------------------------------------------------------------------------------------------------------------------------------------------------------------------------------------------------------------------------------------------------------------------|
| <div style="border: 1px solid black; padding: 5px; margin-bottom: 10px;"> Displ Setup ▼1: Contrast 2: Back-Light 3: Text Color </div> <p>Press  to setting menu.</p> | <div style="border: 1px solid black; padding: 5px; margin-bottom: 5px;"> 1. Contrast </div> <div style="border: 1px solid black; padding: 5px; margin-bottom: 5px;"> Contrast +0  -20 +20 </div> <p>Use Up/Down key to adjust the setting value.</p> <div style="border: 1px solid black; padding: 5px; margin-bottom: 5px;"> Contrast +10  -20 +20 </div> <p>After selecting a setting value. Press ENTER to see screen's display after contrast is adjusted to be +10.</p> <div style="border: 1px solid black; padding: 5px; margin-bottom: 5px;"> Displ Setup ▼1: Contrast 2: Back-Light 3: Text Color </div> <p>When the setting value is 0 Min, the back light will be steady on.</p> <div style="border: 1px solid black; padding: 5px; margin-bottom: 5px;"> Contrast -10  -20 +20 </div> <p>Then press ENTER.</p> <div style="border: 1px solid black; padding: 5px; margin-bottom: 5px;"> Displ Setup ▼1: Contrast 2: Back-Light 3: Text Color </div> <p>After select a setting value Press ENTER to see screen's display result after contrast is adjusted to be -10.</p> <div style="border: 1px solid black; padding: 5px; margin-bottom: 5px;"> 2. Back-light </div> <div style="border: 1px solid black; padding: 5px; margin-bottom: 5px;"> Displ Setup 1: Contrast ◆2: Back-Light 3: Text Color </div> <p>Press ENTER to go to Back Light Time Setting screen.</p> <div style="border: 1px solid black; padding: 5px; margin-bottom: 5px;"> Back-Light Min 5  0 10 </div> <p>Use Up/Down key to adjust the setting value.</p> <div style="border: 1px solid black; padding: 5px; margin-bottom: 5px;"> Back-Light Min 0  0 10 </div> <p>When the setting value is 0 Min, the back light will be steady on.</p> <div style="border: 1px solid black; padding: 5px; margin-bottom: 5px;"> Displ Setup 1: Contrast ◆2: Back-Light 3: Text Color </div> <p>When the setting value is 10 Min, the backlight will be off in 10 minutes.</p> |
|-----------------------------------------------------------------------------------------------------------------------------------------------------------------------------------------------------------------------------------------------------------------------------------------------------------------------------------------|-----------------------------------------------------------------------------------------------------------------------------------------------------------------------------------------------------------------------------------------------------------------------------------------------------------------------------------------------------------------------------------------------------------------------------------------------------------------------------------------------------------------------------------------------------------------------------------------------------------------------------------------------------------------------------------------------------------------------------------------------------------------------------------------------------------------------------------------------------------------------------------------------------------------------------------------------------------------------------------------------------------------------------------------------------------------------------------------------------------------------------------------------------------------------------------------------------------------------------------------------------------------------------------------------------------------------------------------------------------------------------------------------------------------------------------------------------------------------------------------------------------------------------------------------------------------------------------------------------------------------------------------------------------------------------------------------------------------------------------------------------------------------------------------------------------------------------------------------------------------------------------------------------------------------------------------------------------------------------------------------------------------------------------------------------------------------------------------------------------------------------------------------------------------------------------------------------------------------------------------------------------------------------------------------------------------------------------------------------------------------------------------------------------------------------------------------------------------------------------------------------------------------------------------------------------------------------------------------------------------------------------------------------------------------------------------------------------------------------------------------------------------------------------------------------------------------------------------------------------------------------------------------------------------------------------------------------------------------------------------------------------------------------------------------------------------------------------|

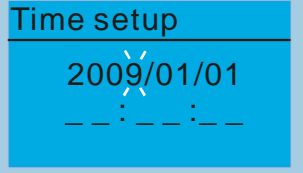
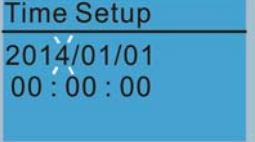
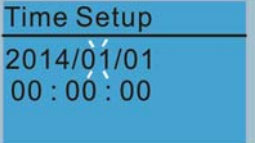
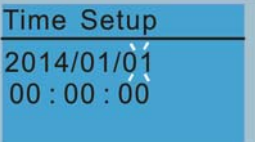
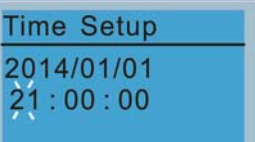
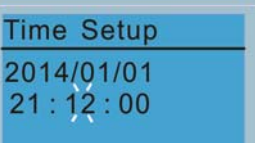
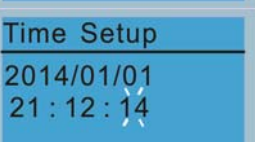
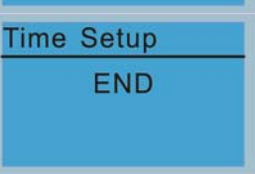

6. Time Setting

| | | |
|---------------------------------------------------------------------------------------------------------------------------------------------------------------------------------------------------------------------------------------------------------|--------------------------------------------------------------------------------------------------------------------------------------------------------------------------------------------------------------------------------------------------------------------------------------------------------------------------------------------------------------------------------------------------------------------------------------------------------------------------------------------------------------------------------------------------------------------------------------------------|----------------------------------------------------------------------------------------------------------------------------------------------------------------------------------------------------------------------------------------------------------------------------------------------------|
|  <p>Use Left/Right key to select Year, Month, Day, Hour, Minute or Second to set up</p> |        | <p>Use Up/Down key to set up Year</p> <p>Use Up/Down key to set up Month</p> <p>Use Up/Down key to set up day</p> <p>Use Up/Down key to set up hour</p> <p>Use Up/Down key to set up Minute</p> <p>Use Up/Down key to set up Second</p> <p>After setting up, press ENTER to confirm the setup.</p> |
| <p> NOTE</p> <p>When the digital keypad is removed, the time setting will be in standby status for 7 days. After this period, the time needs to be reset.</p> | | |

7. Language setup

| | | | | | | | | | |
|--------------------------------------------------------------------------------------------------------------------------------------------------|-------------------------------------------------------------------------------------------------------------------------------------------------------------------------------------------------------------------------------------------------------------------------------------------------------------------------------------|------------|----|---------|------------|---------|--------------|-----------|--|
|  <p>Use Up/Down key to select language, than press ENTER.</p> | <p>Language setting option is displayed in the language of the user's choice.</p> <p>Language setting options:</p> <table border="0"> <tr> <td>1. English</td> <td>5.</td> </tr> <tr> <td>2. 繁體中文</td> <td>6. Espanol</td> </tr> <tr> <td>3. 简体中文</td> <td>7. Portugues</td> </tr> <tr> <td>4. Turkce</td> <td></td> </tr> </table> | 1. English | 5. | 2. 繁體中文 | 6. Espanol | 3. 简体中文 | 7. Portugues | 4. Turkce | |
| 1. English | 5. | | | | | | | | |
| 2. 繁體中文 | 6. Espanol | | | | | | | | |
| 3. 简体中文 | 7. Portugues | | | | | | | | |
| 4. Turkce | | | | | | | | | |

8. Startup

| | |
|--------------------------------------------------------------------------------------------------------------------------------------|------------------------------------------------------------------------------------------------------------------------------------------------------------------------------------------------------------------------------------------------------------------------------------------------------------------------------------------------------------------------------------------------------------------------------------------------------------------------------------------------------------------------------------------------------------------------------------------------------------------------------------------------------------------------------------------------------------------------------------------------------------------------------------------------------------------------------------------------------------------------------------------------------------------------------------------------------------------------------------------------------------------------------------------------------------------------------------|
| <p>Start-up</p> <ul style="list-style-type: none"> ▼ 1.Default 1 ● 2.Default 2 3.User Define | <p>1. Default 1 DELTA LOGO</p>  <p>2. Default 2 DELTA Text</p>  <p>3. User Defined: optional accessory is require (TPEditor & USB/RS-485 Communication Interface-IFD6530)</p> <p>Install an editing accessory would allow users to design their own start-up page.If editor accessory is not installed, “user defined” option will display a blank page.</p>  <p><u>USB/RS-485 Communication Interface-IFD6530</u> Please refer to Chapter 07 Optional Accessories for more detail.</p> <p><u>TPEditor</u> Go to Delta’s website to download TPEditor V1.30.6 or later versions. http://www.delta.com.tw/ch/product/em/download/download_main.asp?act=3&pid=1&cid=1&tpid=3</p> |
|--------------------------------------------------------------------------------------------------------------------------------------|------------------------------------------------------------------------------------------------------------------------------------------------------------------------------------------------------------------------------------------------------------------------------------------------------------------------------------------------------------------------------------------------------------------------------------------------------------------------------------------------------------------------------------------------------------------------------------------------------------------------------------------------------------------------------------------------------------------------------------------------------------------------------------------------------------------------------------------------------------------------------------------------------------------------------------------------------------------------------------------------------------------------------------------------------------------------------------|

9. Mian Pge

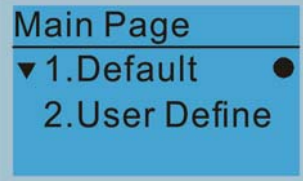

Default picture and editable picture are available upon selection.

Press  to select.

1. Default page

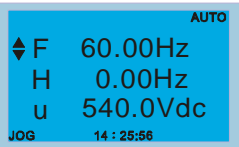

F 600.00Hz >>> H >>> A >>> U (circulate)

2. User Defined: optional accessory is require (TPEditor & USB/RS-485 Communication Interface-IFD6530)
Install an editing accessory would allow users to design their own start-up page. If editor accessory is not installed, "user defined" option will display a blank page.

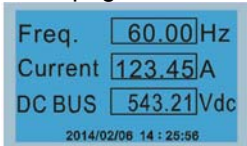
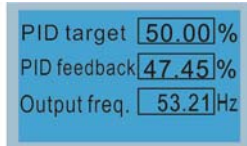
USB/RS-485 Communication Interface-IFD6530
Please refer to Chapter 07 Optional Accessories for more detail.

TPEditor
Go to Delta's website to download TPEditor V1.30.6 or later versions.
http://www.delta.com.tw/ch/product/em/download/download_main.asp?act=3&pid=1&cid=1&tpid=3

10. PC Link

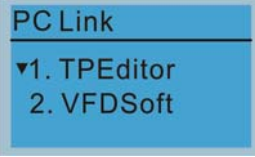

1. TPEditor: This function allows users to connect the keypad to a computer then to download and edit user defined pages.

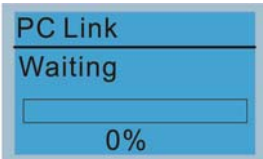

Click ENTER to go to <Waiting to connect to PC>

In TPEditor, choose <Communication>, then choose "Write to HMI"

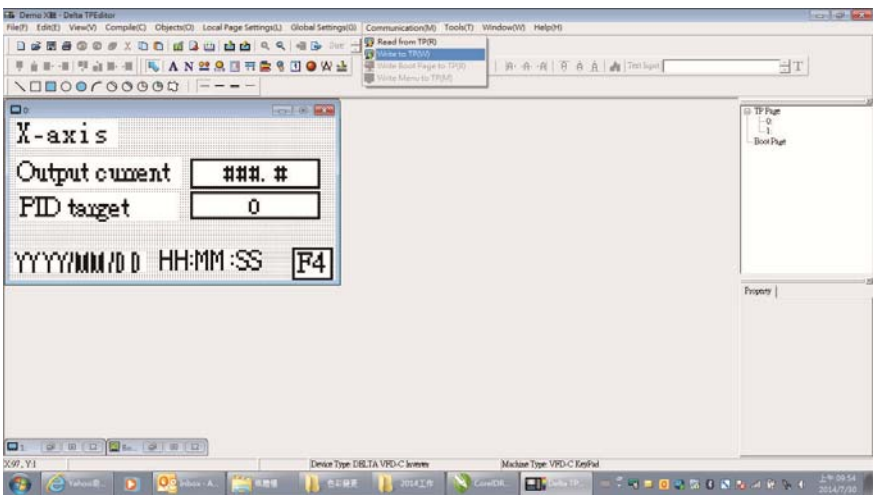

Choose <YES> in the <Confirm to Write> dialogue box.

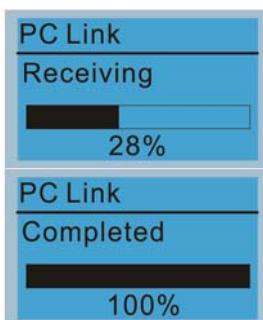
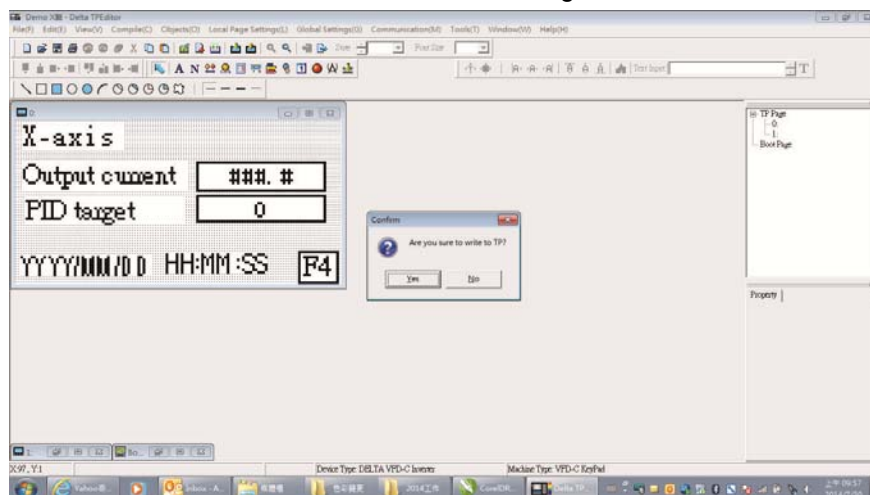

Start downloading pages to edit KPC-CC01.

Download completed

2. VFDSOft: this function allows user to link to the VFDSOft Operating software then to upload data
Copy parameter 1~4 in KPC-CC01
Connect KPC-CC01 to a computer

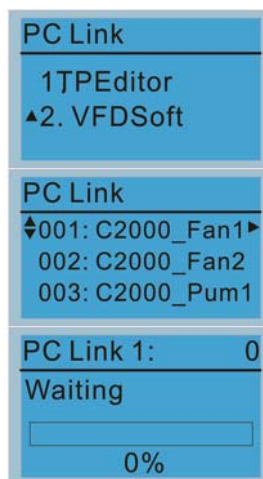

Start downloading pages to edit to KPC-CC01

Use Up/Down key to select a parameter group to upload to VFDSOft. Press ENTER

Waiting to connect to PC

Open VFDSOft, choose <Parameter Manager function>

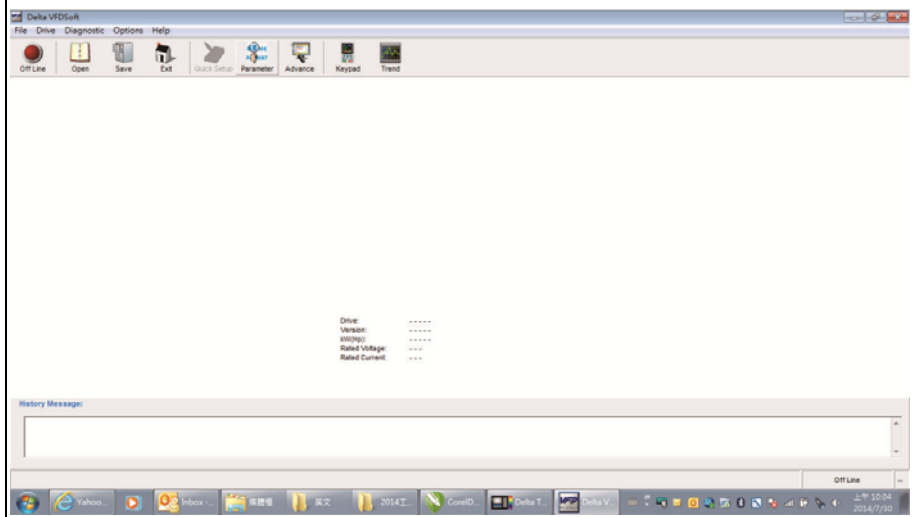

In Parameter Manager, choose <Load parameter table from KPC-CC01>

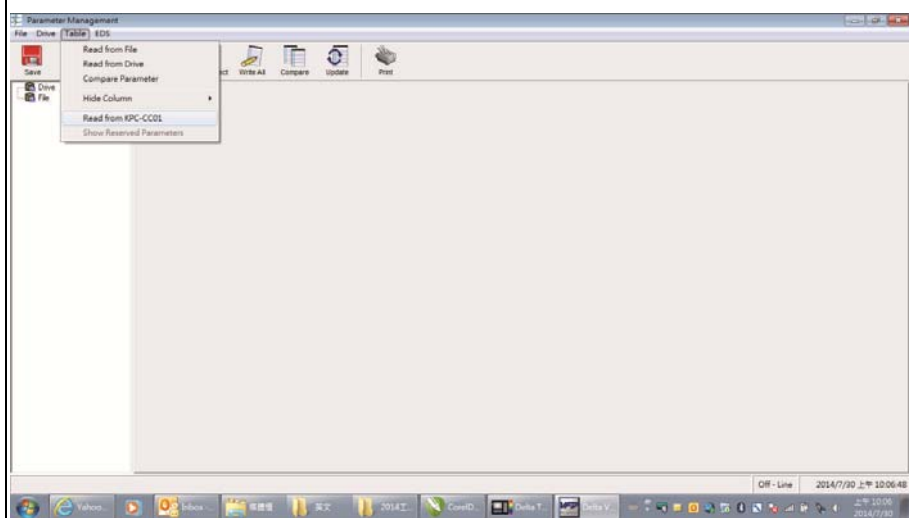

Choose the right communication port and click OK

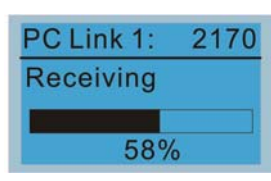
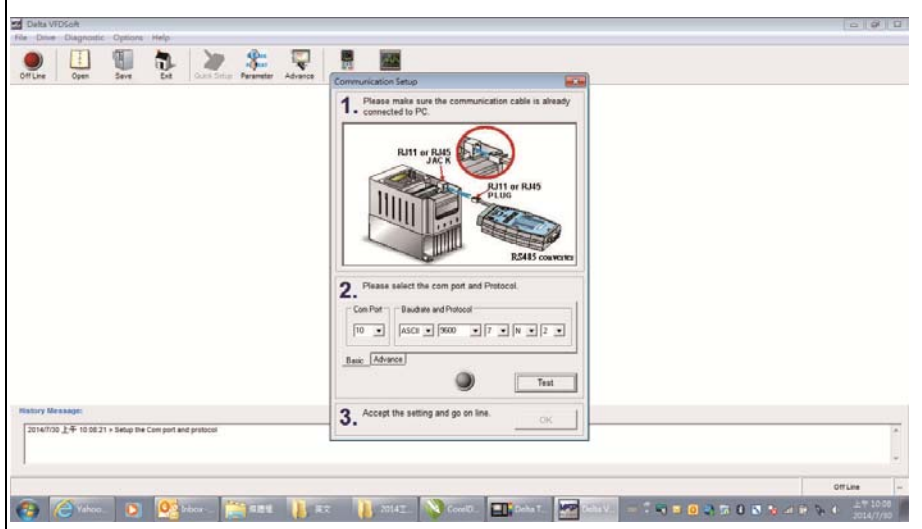

Start to upload parameters to VFDSOft

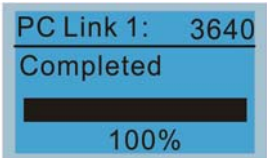
| | |
|--|----------------------------------------------------------------------------------------------------------------------------------------------------------------------------------------------------------------------------------------------------------------------------------------------------------------------------------------------------------------------------------------------------------------------------|
| |  <p>Uploading parameter is completed</p> <p>Before using the user defined starting screen and user defined main screen, the starting screen setup and the main screen setup have to be preset as user defined.</p> <p>If the user defined page are not downloaded to KPC-CC01, the starting screen and the main screen will be blank.</p> |
|--|----------------------------------------------------------------------------------------------------------------------------------------------------------------------------------------------------------------------------------------------------------------------------------------------------------------------------------------------------------------------------------------------------------------------------|

Other Display

When fault occur, the menu will display:

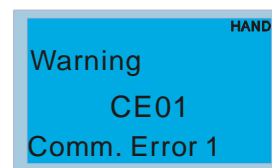
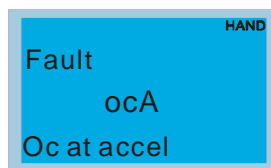

1. Press ENTER and start RESET. If still no response, please contact local distributor or return to the factory. To view the fault DC BUS voltage, output current and output voltage, press "MENU"→"Fault Record".
2. Press ENTER again, if the screen returns to main page, the fault is clear.
3. When fault or warning message appears, backlight LED will blinks until the fault or the warning is cleared.

Optional accessory: RJ45 Extension Lead for Digital Keypad

| Part No. | Description |
|-----------|----------------------------------------------------|
| CBC-K3FT | RJ45 extension lead, 3 feet (approximately 0.9m) |
| CBC-K5FT | RJ45 extension lead, 5 feet (approximately 1.5 m) |
| CBC-K7FT | RJ45 extension lead, 7 feet (approximately 2.1 m) |
| CBC-K10FT | RJ45 extension lead, 10 feet (approximately 3 m) |
| CBC-K16FT | RJ45 extension lead, 16 feet (approximately 4.9 m) |

Note: When you need to buy communication cables, buy non-shielded , 24 AWG, 4 twisted pair, 100 ohms communication cables.

9-5 Digital Keypad KPC-CC01 Fault Codes and Descriptions

Fault Codes:

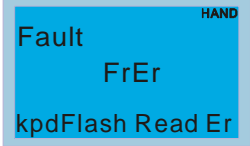
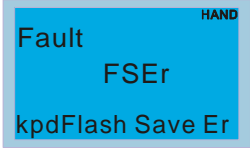
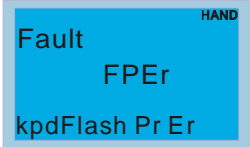
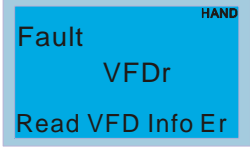
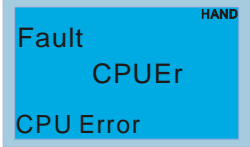
| LCM Display * | Description | Corrective Actions |
|-------------------------------------------------------------------------------------|----------------------------------------------|-----------------------------------------------------------------------------------------------------------------------------------------------------------------------------------------------------------------------------------------------------------------------------------------------------------------------------------------------------------------------------------------------------------------------------------------------------------------------------------------------------------------|
|  | Keypad flash memory read error | <p>An error has occurred on keypad's flash memory.</p> <ol style="list-style-type: none"> 1. Press RESET on the keypad to clear errors. 2. Verify what kind of error has occurred on keypad's flash memory. 3. Shut down the system, wait for ten minutes, and then power on again the system. <p>If none of the solution above works, contact your authorized local dealer.</p> |
|  | Keypad flash memory save error | <p>An error has occurred on keypad's flash memory.</p> <ol style="list-style-type: none"> 1. Press RESET on the keypad to clear errors. 2. Press RESET on the keypad to clear errors. 3. Shut down the system, wait for ten minutes, and then power on again the system. <p>If none of the solution above works, contact your authorized local dealer.</p> |
|  | Keypad flash memory parameter error | <p>Errors occurred on parameters of factory setting. It might be caused by firmware update.</p> <ol style="list-style-type: none"> 1. Press RESET on the keypad to clear errors. 2. Verify if there's any problem on Flash IC. 3. Shut down the system, wait for ten minutes, and then power on again the system. <p>If none of the solution above works, contact your local authorized dealer.</p> |
|  | Keypad flash memory read AC drive data error | <p>Keypad can't read any data sent from VFD.</p> <ol style="list-style-type: none"> 1. Verify if the keypad is properly connect to the motor drive by a communication cable such as RJ-45. 2. Press RESET on the keypad to clear errors. 3. Shut down the system, wait for ten minutes, and then power on again the system. <p>If none of the solution above works, contact your local authorized dealer.</p> |
|  | and then power on again the system. | <p>A Serious error has occurred on keypad's CPU.</p> <ol style="list-style-type: none"> 1. Verify if there's any problems on CPU clock? 2. Verify if there's any problem on Flash IC? 3. Verify if there's any problem on RTC IC? 4. Verify if the communication quality of the RS485 is good? 5. Shut down the system, wait for ten minutes, and then power on again the system. If none of the solution above works, contact your local authorized dealer. |

Warning Codes:

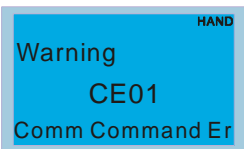
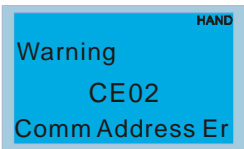
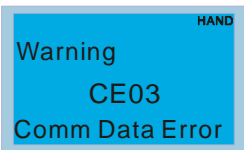
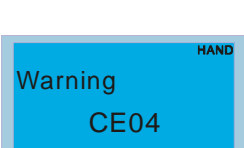
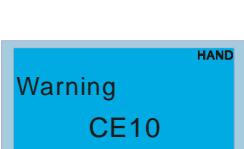
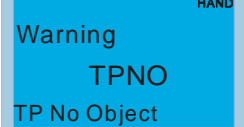
| LCM Display * | Description | Corrective Actions |
|----------------------------------------------------------------------------------------------------------------------------------|-----------------------------------|----------------------------------------------------------------------------------------------------------------------------------------------------------------------------------------------------------------------------------------------------------------------------------------------------------------------------------------------------------------------------------------------------------------------------------------------------------------------------------------------------------------|
|  <p>Warning CE01 Comm Command Er</p> | Modbus function code error | <p>Motor drive doesn't accept the communication command sent from keypad.</p> <ol style="list-style-type: none"> 1. Verify if the keypad is properly connected to the motor drive on the communication contact by a communication cable such as RJ-45. 2. Press RESET on the keypad to clear errors. <p>If none of the solution above works, contact your local authorized dealer.</p> |
|  <p>Warning CE02 Comm Address Er</p> | Modbus data address error | <p>Motor rive doesn't accept keypad's communication address.</p> <ol style="list-style-type: none"> 1. Verify if the keypad is properly connected to the motor drive on the communication contact by a communication cable such as RJ-45. 2. Press RESET on the keypad to clear errors. <p>If none of the solution above works, contact your local authorized dealer.</p> |
|  <p>Warning CE03 Comm Data Error</p> | Modbus data value error | <p>Motor drive doesn't accept the communication data sent from keypad.</p> <ol style="list-style-type: none"> 1. Verify if the keypad is properly connected to the motor drive on the communication contact by a communication cable such as RJ-45. 2. Press RESET on the keypad to clear errors. <p>If none of the solution above works, contact your local authorized dealer.</p> |
|  <p>Warning CE04 Comm Slave Error</p> | Modbus slave drive error | <p>Motor drive cannot process the communication command sent from keypad.</p> <ol style="list-style-type: none"> 1. Verify if the keypad is properly connected to the motor drive on the communication contact by a communication cable such as RJ-45. 2. Press RESET on the keypad to clear errors. 3. Shut down the system, wait for ten minutes, and then power on again the system. <p>If none of the solution above works, contact your local authorized dealer.</p> |
|  <p>Warning CE10 KpdComm Time Out</p> | Modbus transmission time-Out | <p>Motor drive doesn't respond to the communication command sent from keypad.</p> <ol style="list-style-type: none"> 1. Verify if the keypad is properly connected to the motor drive on the communication contact by a communication cable such as RJ-45. 2. Press RESET on the keypad to clear errors. 3. Shut down the system, wait for ten minutes, and then power on again the system. <p>If none of the solution above works, contact your local authorized dealer.</p> |
|  <p>Warning TPNO TP No Object</p> | Object not supported by TP Editor | <p>Keypad's TP Editor uses unsupported object.</p> <ol style="list-style-type: none"> 1. Verify how the TP editor should use that object. Delete unsupported object and unsupported setting. 2. Reedit the TP editor and then download it. <p>If none of the solution above works, contact your local authorized dealer.</p> |

File Copy Setting Fault Description

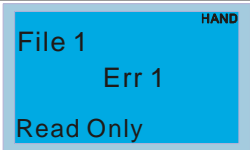
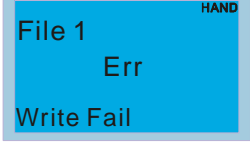
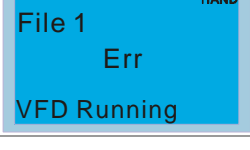
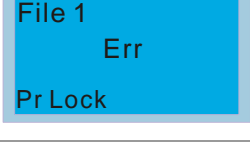
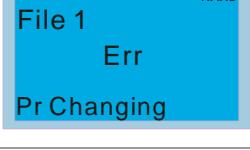
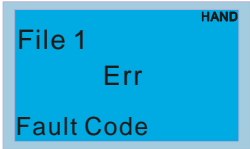
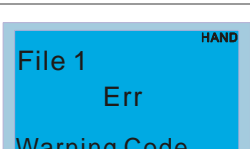
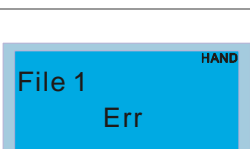
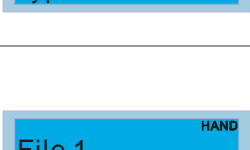
| LCM Display * | Description | Corrective Actions |
|-------------------------------------------------------------------------------------|----------------------------------|----------------------------------------------------------------------------------------------------------------------------------------------------------------------------------------------------------------------------------------------------------------------------------------------------------------------------------------------------|
|  | Parameter and file are read only | The property of the parameter/file is read-only and cannot be written to. 1. Verify the specification on the user manual. If the solution above doesn't work, contact your local authorized dealer. |
|  | Fail to write parameter and file | An error occurred while write to a parameter/file. 1. Verify if there's any problem on the Flash IC. 2. Shut down the system, wait for ten minutes, and then power on again the system. If none of the solution above work, contact your local authorized dealer. |
|  | AC drive is in operating status | A setting cannot be made while motor drive is in operation. 1. Verify if the drive is not in operation. If the solution above doesn't work, contact your local authorized dealer. |
|  | AC drive parameter is locked | A setting cannot be made because a parameter is locked. 1. Verify if the parameter is locked or not. If it is locked, unlock it and try to set up the parameter again. If the solution above doesn't work, contact your local authorized dealer. |
|  | AC drive parameter changing | A setting cannot be made because a parameter is being modified. 1. Verify if the parameter is being modified. If it is not being modified, try to set up that parameter again. If the solution above doesn't work, contact your local authorized dealer. |
|  | Fault code | A setting cannot be made because an error has occurred on the motor drive. 1. Verify if there's any error occurred on the motor drive. If there isn't any error, try to make the setting again. If the solution above doesn't work, contact your local authorized dealer. |
|  | Warning code | A setting cannot be made because of a warning message given to the motor drive. 1. Verify if there's any warning message given to the motor drive. If the solution above doesn't work, contact your local authorized dealer. |
|  | File type dismatch | Data need to be copied are not same type, so the setting cannot be made. 1. Verify if the products' serial numbers need to be copied fall in the category. If they are in the same category, try to make the setting again. If the solution above doesn't work, contact your authorized dealer. |
|  | File is locked with password | A setting cannot be made, because some data are locked. 1. Verify if the data are unlocked or able to be unlocked. If the data are unlocked, try to make the setting again. 2. Shut down the system, wait for ten minutes, and then power on again the system. If none of the solution above works, contact your local authorized dealer. |

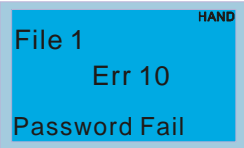
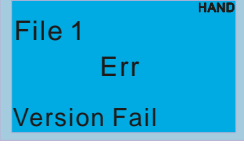
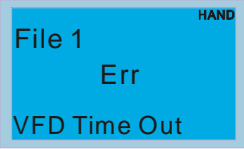
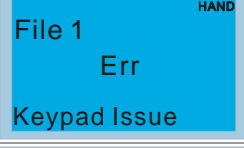
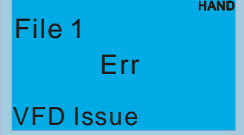
| LCM Display * | Description | Corrective Actions |
|-------------------------------------------------------------------------------------|---------------------------------|-----------------------------------------------------------------------------------------------------------------------------------------------------------------------------------------------------------------------------------------------------------------------------------------------------------------------------------------------------------------------------------------------------------------------------|
|  | File version mismatch | <p>A setting cannot be made because the password is incorrect.</p> <ol style="list-style-type: none"> 1. Verify if the password is correct. If the password is correct, try to make the setting again. 2. Shut down the system, wait for ten minutes, and then power on again the system. <p>If none of the solution above works, contact your local authorized dealer.</p> |
|  | AC drive copy function time-out | <p>A setting cannot be made, because the version of the data is incorrect.</p> <ol style="list-style-type: none"> 1. Verify if the version of the data matches the motor drive. If it matches, try to make the setting again. <p>If none of the solution above works, contact your local authorized dealer.</p> |
|  | Other keypad error | <p>A setting cannot be made, because data copying timeout expired.</p> <ol style="list-style-type: none"> 1. Redo data copying. 2. Verify if copying data is authorized. If it is authorized, try again to copy data. 3. Shut down the system, wait for ten minutes, and then power on again the system. <p>If none of the solution above works, contact your local authorized dealer.</p> |
|  | Other AC drive error | <p>This setting cannot be made, due to other keypad issues. (Reserved functions)</p> <p>If such error occurred, contact your local authorized dealer.</p> |
|  | File is locked with password | <p>This setting cannot be made, due to other motor drive issues. (Reserved functions).</p> <p>If such error occurred, contact your local authorized dealer.</p> |

※ The content in this chapter only applies on V1.01 and above of KPC-CC01 keypad.

9-6 TPEditor Installation

TPEditor can edit up to 256 HMI (Human-Machine Interface) pages with a total storage capacity of 256kb. Each page can edit 50 normal objects and 10 communication objects.

1) TPEditor: Setup & Basic Functions

1. Run TPEditor version 1.60 or later.



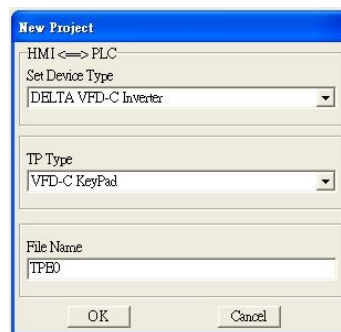

2. Go to File(F)→Click on New. The Window below will pop up. At the device type, click on the drop down menu and choose DELTA VFD-C Inverter. At the TP type, click on the drop down menu and choose VFD-C KeyPad. As for File Name, enter TPE0. Now click on OK.



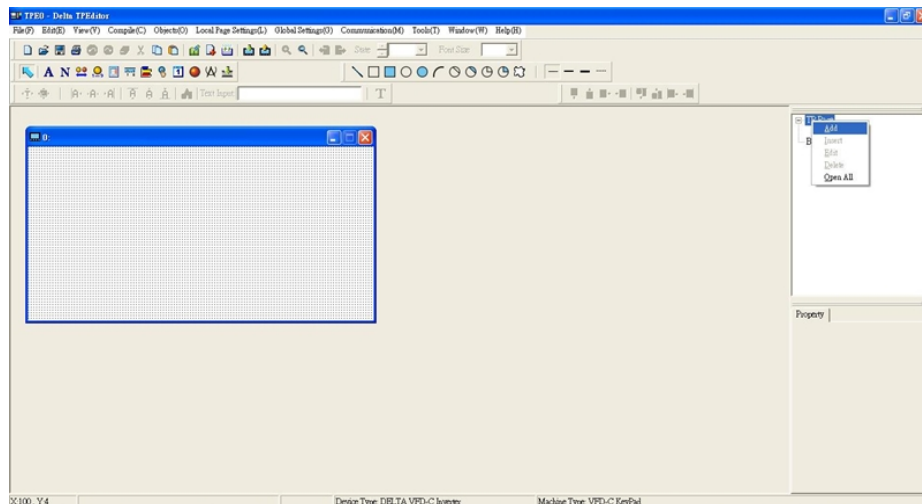

3. You are now at the designing page. Go to Edit (E)→Click on Add a New Page (A) or go to the TP page on the upper right side, right click once on TP page and choose Add to increase one more page for editing. The current firmware of Keypad is version1.00 and can support up to 4 pages.

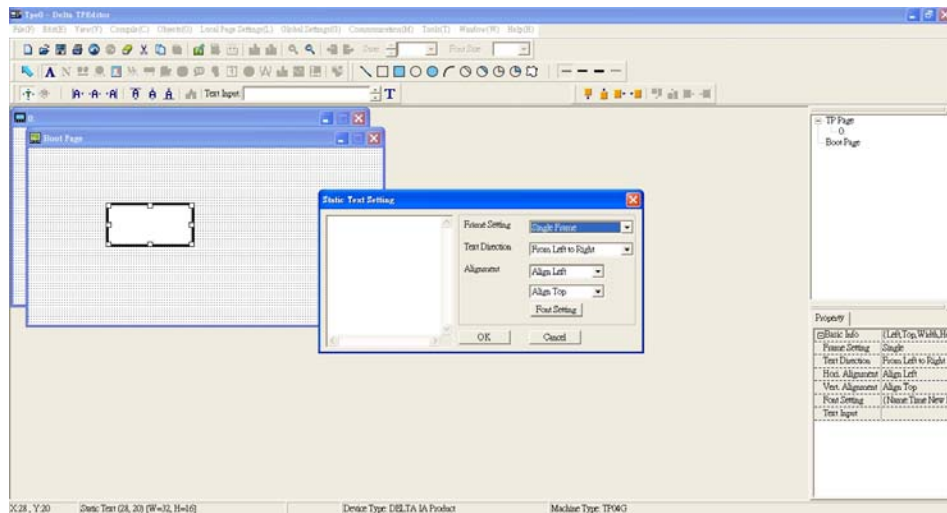

4. Edit Startup Page

5. Static Text  . Open a blank page, click once on this button  , and then double click on that blank page. The following windows will pop up.



6. Static Bitmap  → Open a blank page, then click once on this button  and then double click on that blank page. The following window will pop up.

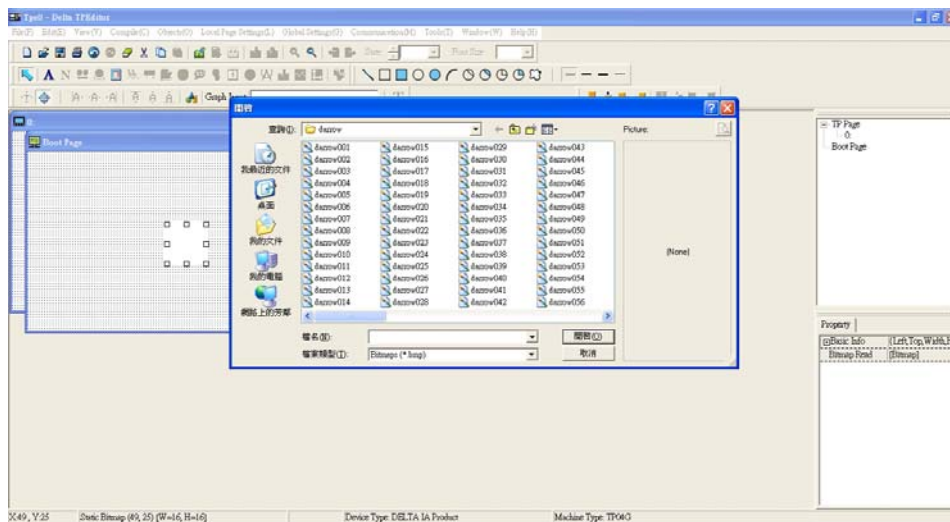

Please note that Static Bitmap setting support only images in BMP format. Now choose a image that you need and click open, then that image will appear in the Static Bitmap window.

7. Geometric Bitmap  → As shown in the picture on the left side, there are 11 kinds of geometric bitmap to choose. Open a new blank page then click once on a geometric bitmap icon that you need. Then drag that icon and enlarge it to the size that you need on that blank page.

8. Finish editing the keypad starting screen and select **Communication>Input User Defined Keypad Starting Screen**.

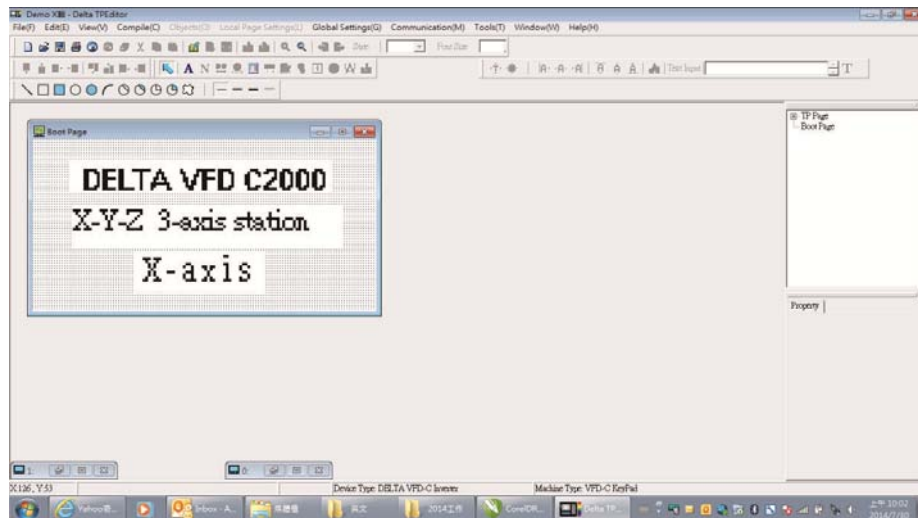

9. Downloading setting: Go to Tool > Communication. Set up communication port and speed of IFD6530.
10. Only three speed selections are available: 9600 bps, 19200 bps and 38400 bps.

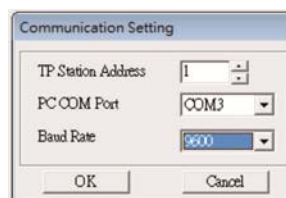

11. When a dialogue box displayed on the screen asking to confirm writing or not, press buttons on the keypad to go to MENU, select PC LINK and then press ENTER and wait for few seconds. Then select YES on the screen to start downloading.

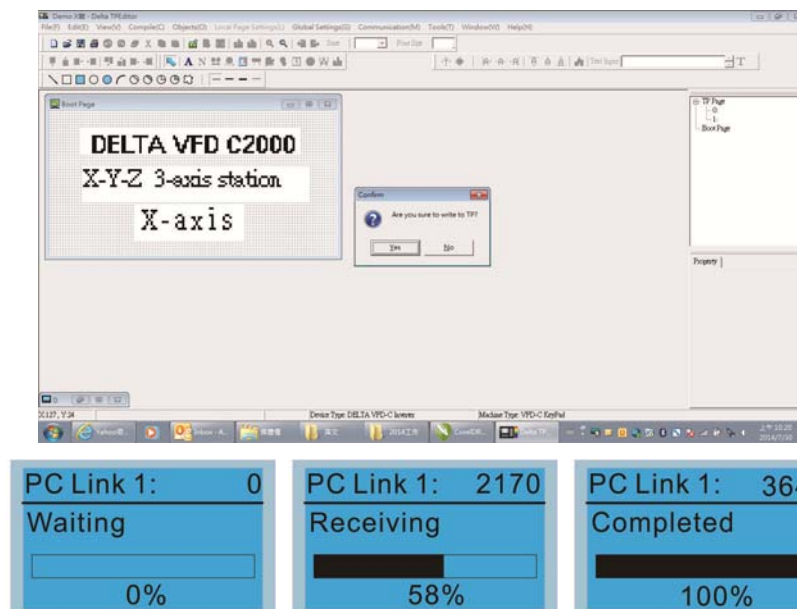

2) Edit Main Page & Example of Download

1. Go to editing page, select Edit→Add one page or press the button ADD on the right hand side of the HMI page to increase number of pages to edit. This keypad currently support up to 256 pages.

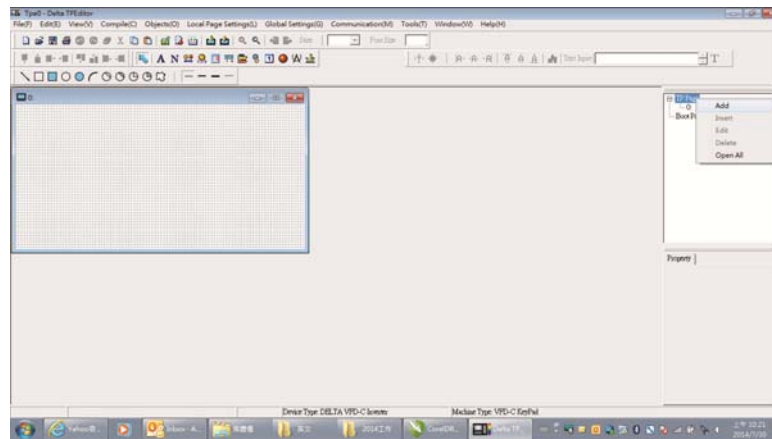

2. On the bottom right-hand corner of the HMI, click on a page number to edit or go to VIEW >HMI page to start editing main page. As shown in the image, the following objects are available. From left to right: Static Text, ASCII Display, Static Bitmap, Scale, Bar Graph, Button, Clock Display, Multi-state bit map, Units, Numeric Input and 11 geometric bitmaps and lines of different width. The application of Static Text, Static Bitmap, and geometric bitmap is the same as the editing startup page.



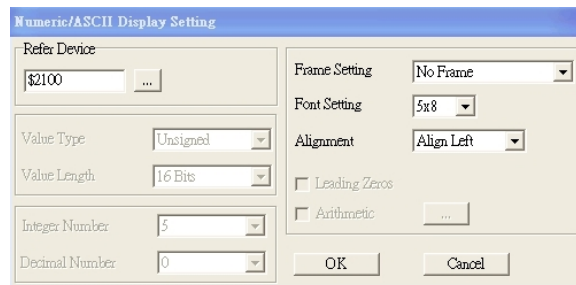

3. Numeric/ASCII Display : To add a Numeric/ASCII Display object to a screen, double click on the object to set up Related Devices, Frame Setting , Fonts and Alignment.



Related Device: Choose the VFD Communication Port that you need, if you want to read output frequency (H), set the VFD Communication Port to \$2202. For other values, please refer to ACMD ModBus Comm Address List.



4. Scale Setting  : On the Tool Bar, click on this  for Scale Setting. You can also edit Scale Setting in the Property Window on the right hand side of your computer screen.

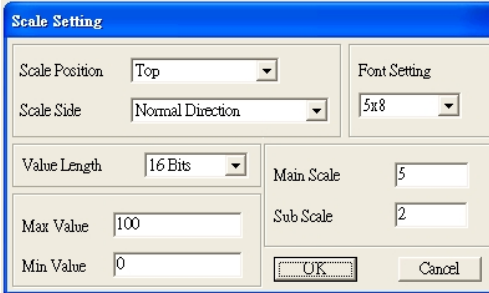

The Scale Setting dialog box contains the following fields and controls:

- Scale Position: Top (dropdown)
- Scale Side: Normal Direction (dropdown)
- Font Setting: 5x8 (dropdown)
- Value Length: 16 Bits (dropdown)
- Main Scale: 5 (text input)
- Sub Scale: 2 (text input)
- Max Value: 100 (text input)
- Min Value: 0 (text input)
- Buttons: OK, Cancel

- Scale Position: Click on the drop down list to choose which position that you need to place a scale.
- Scale Side: Click on the drop down list to choose if you want to number your scale from smaller number to bigger number or from big to small. Click OK to accept this setting or click Cancel to abort.
- Font Setting: Click on the drop down list to choose the Font setting that you need then click OK to accept the setting or click Cancel to abort.
- Value Length: Click on the drop down to choose 16bits or 32 bits. Then click OK to accept the setting or click Cancel to abort.
- Main Scale & Sub Scale: In order to divide the whole scale into equal parts, key in the numbers of your choices for main scale and sub scale.
- Maximum value & Minimum Value are the numbers on the two ends of a scale. They can be negative numbers. But the values allowed to be input are limited by the length of value. For example, when the length of value is set to **be hexadecimal**, the maximum and the minimum value cannot be input as -4000.
Follow the Scale setting mentioned above; you will have a scale as shown below.

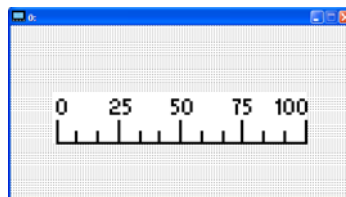

5. Bar Graph setting  :

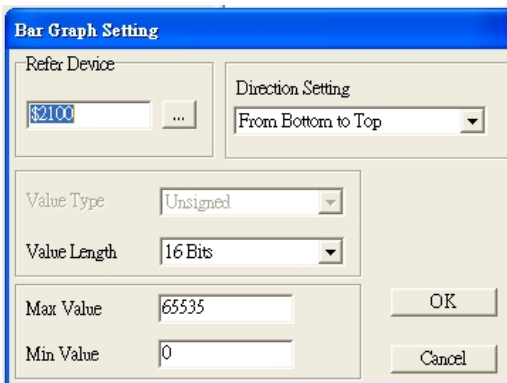

The Bar Graph Setting dialog box contains the following fields and controls:

- Refer Device: \$2100 (text input)
- Direction Setting: From Bottom to Top (dropdown)
- Value Type: Unsigned (dropdown)
- Value Length: 16 Bits (dropdown)
- Max Value: 65535 (text input)
- Min Value: 0 (text input)
- Buttons: OK, Cancel

- Related Device: Choose the VFD Communication Port that you need.
- Direction Setting: Click on the drop down menu to choose one of the following directions: From Bottom to Top, From Top to Bottom, From Left to Right or From Right to Left.
- Maximum Value & Minimum Value: They define the range covered by the maximum value and minimum value. If a value is smaller than or equal to the minimum value, then the bar graph will be blank. If a value is bigger or equal to the maximum value, then the bar graph will be full. If a value is between minimum and maximum value, then the bar graph will be filled proportionally.

6. Button  : Currently this function only allows the Keypad to switch pages, other functions are not yet available. Text input function and Image inserted functions are not yet supported.

Double click on  to open set up window.

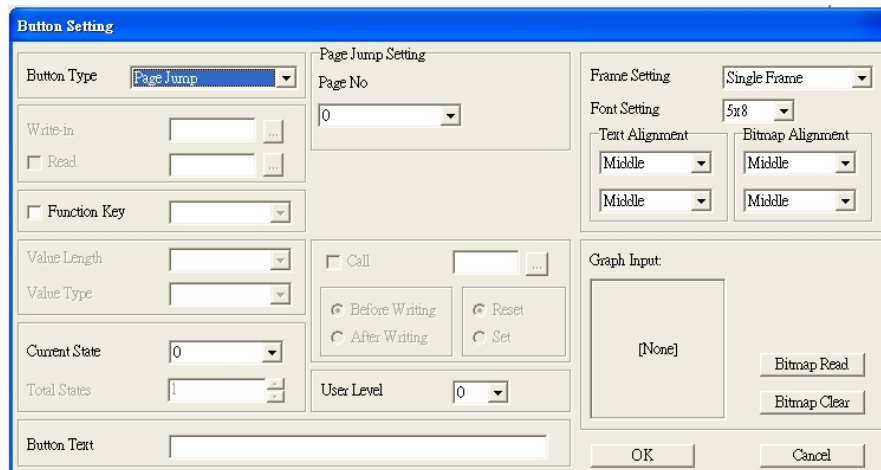

<Button Type> allows users set up buttons' functions. <Page Jump> and <Constant Setting> are the only two currently supported functions.

A [Page Jump] function setting

- Page Jump setting: After you choose the Page Jump function in the drop down list, you will see this Page Jump Setting Menu
- <Function Key> allows you to assign functions to the following keys on the KPC-CC01 keypad: F1, F2, F3, F4, Up, Down, Left and Right. Please note that the Up and Down keys are locked by TPEditor. These two keys cannot be programmed. If you want to program Up and Down keys, go to Tool→Function Key Settings (F)→Re-Define Up/Down Key(R).

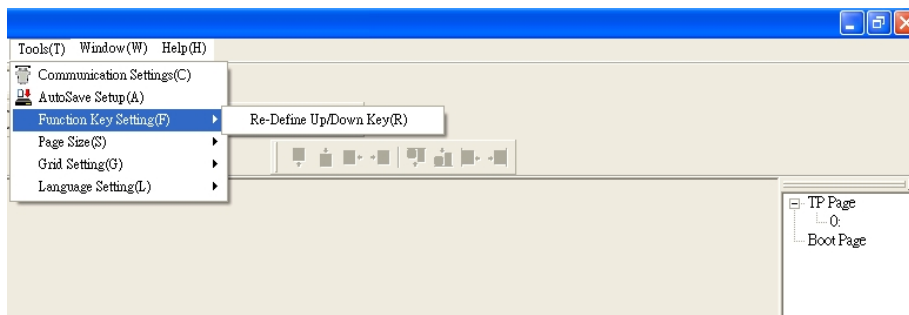

- Button Text: This function allows user to name buttons. For example, key in <Next Page> in the empty space, a button will have the wording <Next Page> displayed on it.

B [Constant setting] function

This function is to set up the memory address' value of the VFD or PLC. When pressing the <function button> set up in before, a value will be written to the memory address of the <Constant Setting>. This function can be used as initializing a variable.



7. Clock Display Setting  : The setup window of the Clock Display is shown as the image below. Time, Day or Date can be displayed on the keypad.
Open a new file and click once in that window, you will see the following
In the clock display setting, you can choose to display Time, Day or Date on the Keypad. To adjust time, go to #9 on the Keypad's menu. You can also adjust Frame Setting, Font Setting and Alignment.

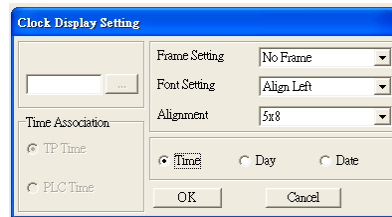

8. Multi-state bitmap  : The setup window of the multi-state is shown as the image below. This object reads the bit's property value of the PLC. It defines what image or wording is when this bit is 0 or when this bit is 1. Set the initial status to be 0 or 1 to define the displayed image or wording.

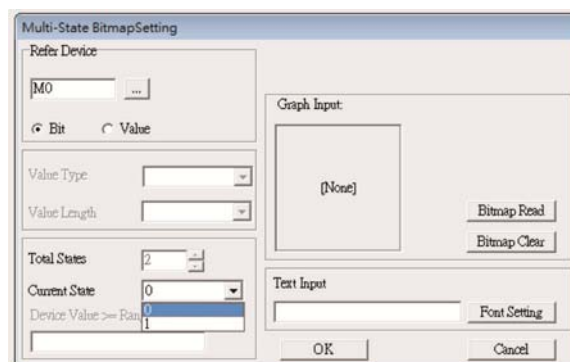

9. Unit Measurement  : Click once on this Button:
Open a new file and double click on that window, you will see the following

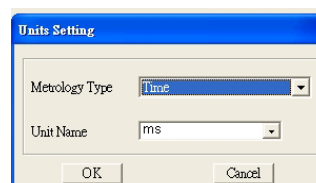

Choose from the drop down list the Metrology and the Unity Name that you need.
As for Metrology, you have the following choices Length, Square Measure, Volume/Solid Measure, Weight, Speed, Time and Temperature. The unit name changes automatically when you change metrology type.

10. Numeric Input Setting

This menu allows you to provide parameters or communication ports and to input numbers.

Click once on this button .

Open a new file and double click on that window, you will see the following:

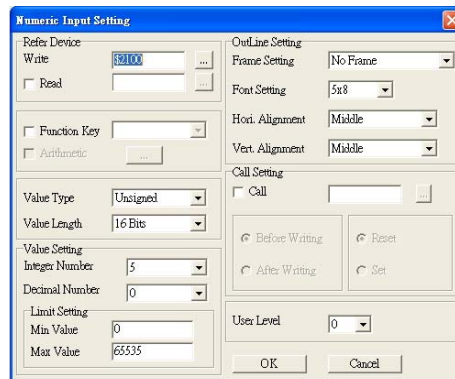

- Related Device: There are two blank spaces to fill in, one is <Write> and another one is <Read>. Input the numbers that you want to display and the corresponding numbers of a parameter and that of a communication port. For example, input 012C to Read and Write Parameter P01-44.
- OutLine Setting: The Frame setting, Font setting, Vertical Alignment and Horizontal Alignment are the same as mentioned before. Click on the drop down menu and choose the setting that you need.
- Function key: The setting here allows you to program keys on the keypad. Press the key on the menu then the corresponding key on the keypad will start to blink, then press Enter to confirm the setting.
- Value Type & Value Length: These two factors influence the range of the Minimum and Maximum Value of the Limit Setting. Please note that the corresponding supporting values for C2000 have to be 16bits. The 32bits values are not supported.
- Value Setting: This part is set automatically by the keypad itself.
- Limit Setting: Input the range the security setting here.
- For example, if you set Function Key as F1, Minimum Value as 0 and Maximum Value as 4, then press F1 on Keypad Then you can press Up and Down key on the keypad to increase or decrease the value. Press Enter Key on the keypad to confirm your setting. You can also go to parameter table 01-44 to verify if your input correctly the value.

11. Download TP Page : Press Up or Down key on the keypad until you reach #13 PC Link.

Then press Enter on the keypad and you will see the word "Waiting" on keypad's screen. Now choose a page that you have created then go to Communication (M)→Write to TP(W) to start downloading the page to the keypad

When you see the word Completed on the keypad's screen, that means the download is done. Then you can press ESC on the keypad to go back to the menu of the keypad.

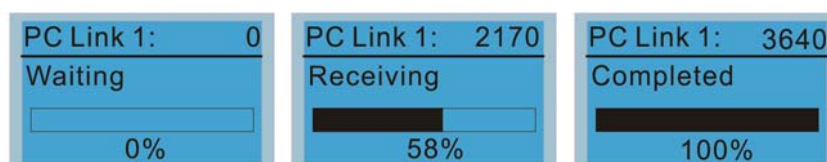
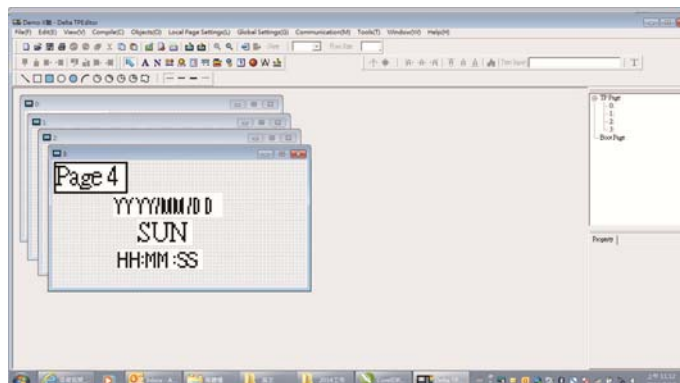

3) Edit Main Page

1. On the bottom right-hand corner of the HMI, click on a page number to edit or go to VIEW >HMI page to start editing main page. As shown in the image, the following objects are available. From left to right: Static Text, ASCII Display, Static Bitmap, Scale, Bar Graph, Button, Clock Display, Multi-state bit map, Units, Numeric Input and 11 geometric bitmaps and lines of different width. The application of Static Text, Static Bitmap, and geometric bitmap is the same as the editing startup page.

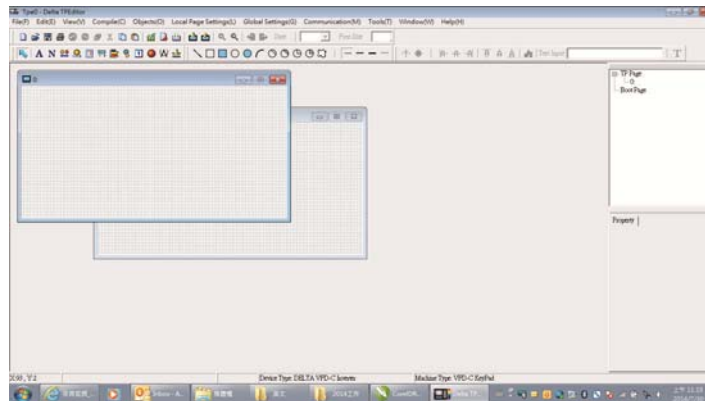

2. Numeric/ASCII Display : To add a Numeric/ASCII Display object to a screen, double click on the object to set up Related Devices, Frame Setting , Fonts and Alignment.

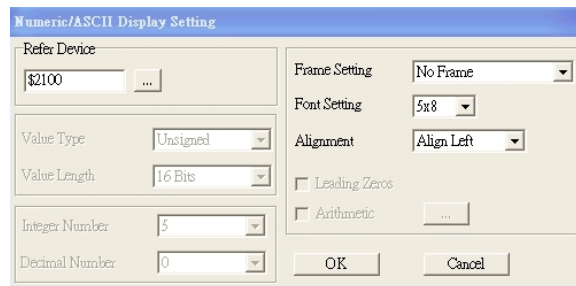

Related Device: Choose the VFD Communication Port that you need, if you want to read output frequency (H), set the VFD Communication Port to \$2202. For other values, please refer to ACMD ModBus Comm Address List.



3. Scale Setting  : On the Tool Bar, click on this  for Scale Setting. You can also edit Scale Setting in the Property Window on the right hand side of your computer screen.

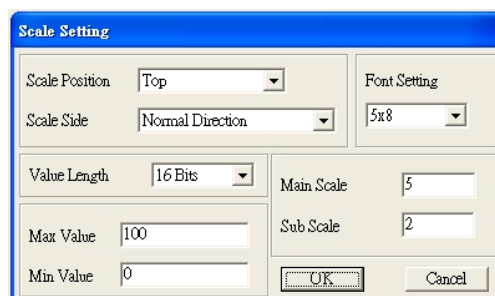

- i. Scale Position: Click on the drop down list to choose which position that you need to place a scale.
- ii. Scale Side: Click on the drop down list to choose if you want to number your scale from smaller number to bigger number or from big to small. Click OK to accept this setting or click Cancel to abort.
- iii. Font Setting: Click on the drop down list to choose the Font setting that you need then click OK to accept the setting or click Cancel to abort.
- iv. Value Length: Click on the drop down to choose 16bits or 32 bits. Then click OK to accept the setting or click Cancel to abort.
- v. Main Scale & Sub Scale: In order to divide the whole scale into equal parts, key in the numbers of your choices for main scale and sub scale.
- vi. Maximum value & Minimum Value are the numbers on the two ends of a scale. They can be negative numbers. But the values allowed to be input are limited by the length of value. For example, when the length of value is set to **be hexadecimal**, the maximum and the minimum value cannot be input as -4000.

Follow the Scale setting mentioned above; you will have a scale as shown below.

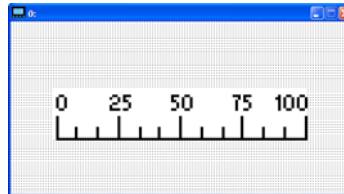

4. Bar Graph setting :

- i. Related Device: Choose the VFD Communication Port that you need.
- ii. Direction Setting: Click on the drop down menu to choose one of the following directions: From Bottom to Top, From Top to Bottom, From Left to Right or From Right to Left.
- iii. Maximum Value & Minimum Value: They define the range covered by the maximum value and minimum value. If a value is smaller than or equal to the minimum value, then the bar graph will be blank. If a value is bigger or equal to the maximum value, then the bar graph will be full. If a value is between minimum and maximum value, then the bar graph will be filled proportionally.

5. Button : Currently this function only allows the Keypad to switch pages, other functions are not yet available. Text input function and Image inserted functions are not yet supported.

Double click on  to open set up window.

<Button Type> allows users set up buttons' functions. <Page Jump> and <Constant Setting> are the only two currently supported functions.

A [Page Jump] function setting

- Page Jump setting: After you choose the Page Jump function in the drop down list, you will see this Page Jump Setting Menu
- <Function Key> allows you to assign functions to the following keys on the KPC-CC01 keypad: F1, F2, F3, F4, Up, Down, Left and Right. Please note that the Up and Down keys are locked by TPEditor. These two keys cannot be programmed. If you want to program Up and Down keys, go to Tool→Function Key Settings (F)→Re-Define Up/Down Key(R).

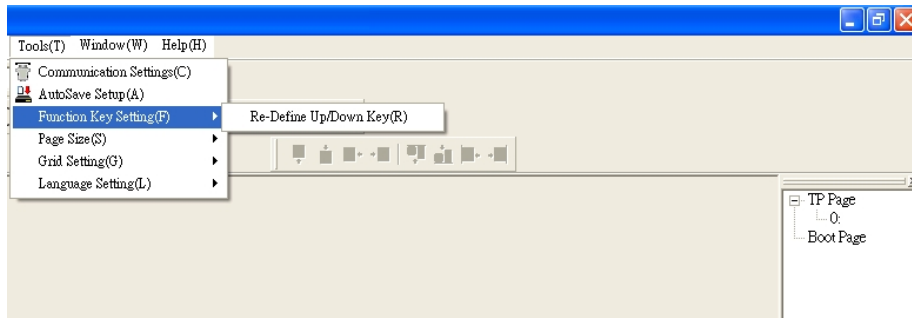

- Button Text: This function allows user to name buttons. For example, key in <Next Page> in the empty space, a button will have the wording <Next Page> displayed on it.

B [Constant setting] function

This function is to set up the memory address' value of the VFD or PLC. When pressing the <function button> set up in before, a value will be written to the memory address of the <Constant Setting>. This function can be used as initializing a variable.

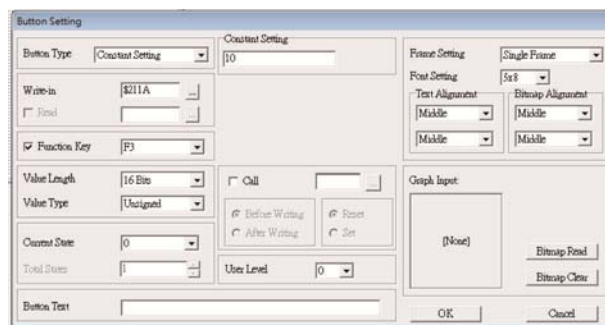

11. Clock Display Setting : The setup window of the Clock Display is shown as the image below. Time, Day or Date can be displayed on the keypad.

Open a new file and click once in that window, you will see the following

In the clock display setting, you can choose to display Time, Day or Date on the Keypad. To adjust time, go to #9 on the Keypad's menu. You can also adjust Frame Setting, Font Setting and Alignment.

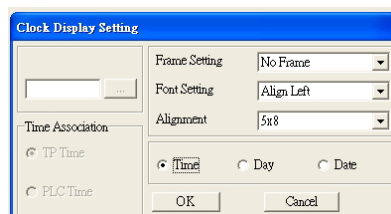

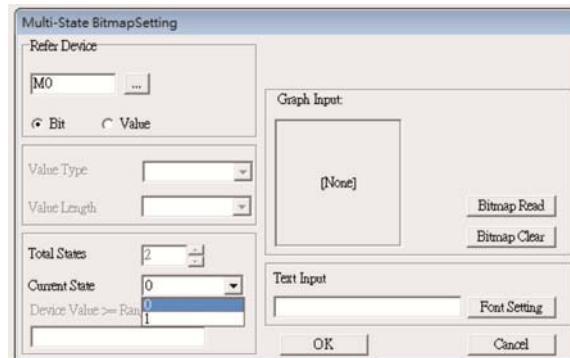

12. Multi-state bitmap : The setup window of the multi-state is shown as the image below. This object reads the bit's property value of the PLC. It defines what image or wording is when this bit is 0 or when this bit is 1. Set the initial status to be 0 or 1 to define the displayed image or wording.

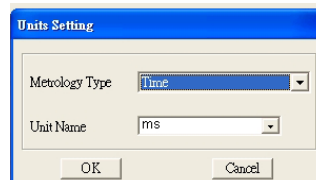

13. Unit Measurement : Click once on this Button:
Open a new file and double click on that window, you will see the following



Choose from the drop down list the Metrology and the Unity Name that you need. As for Metrology, you have the following choices Length, Square Measure, Volume/Solid Measure, Weight, Speed, Time and Temperature. The unit name changes automatically when you change metrology type.

14. Numeric Input Setting :
This menu allows you to provide parameters or communication ports and to input numbers.
Click once on this button .
Open a new file and double click on that window, you will see the following:

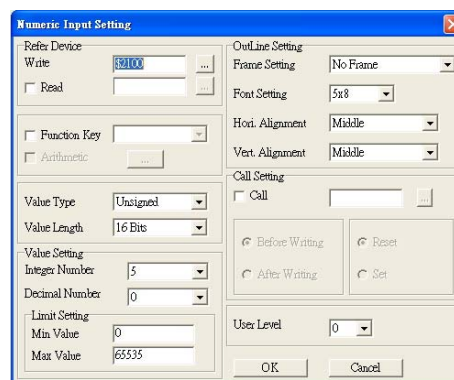

- h. Related Device: There are two blank spaces to fill in, one is <Write> and another one is <Read>. Input the numbers that you want to display and the corresponding numbers of a parameter and that of a communication port. For example, input 012C to Read and Write Parameter P01-44.
- i. OutLine Setting: The Frame setting, Font setting, Vertical Alignment and Horizontal Alignment are the same as mentioned before. Click on the drop down menu and choose the setting that you need.
- j. Function key: The setting here allows you to program keys on the keypad. Press the key on the menu then the corresponding key on the keypad will start to blink, then press Enter to confirm the setting.
- k. Value Type & Value Length: These two factors influence the range of the Minimum and Maximum Value of the Limit Setting. Please note that the corresponding supporting values for C2000 have to be 16bits. The 32bits values are not supported.
- l. Value Setting: This part is set automatically by the keypad itself.

- m. Limit Setting: Input the range the security setting here.
- n. For example, if you set Function Key as F1, Minimum Value as 0 and Maximum Value as 4, then press F1 on Keypad Then you can press Up and Down key on the keypad to increase or decrease the value. Press Enter Key on the keypad to confirm your setting. You can also go to parameter table 01-44 to verify if your input correctly the value.

15. Download TP Page : Press Up or Down key on the keypad until you reach #13 PC Link.

Then press Enter on the keypad and you will see the word "Waiting" on keypad's screen. Now choose a page that you have created then go to Communication (M)→Write to TP(W) to start downloading the page to the keypad

When you see the word Completed on the keypad's screen, that means the download is done. Then you can press ESC on the keypad to go back to the menu of the keypad.

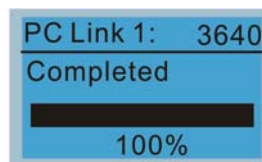
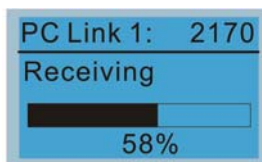
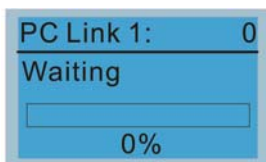
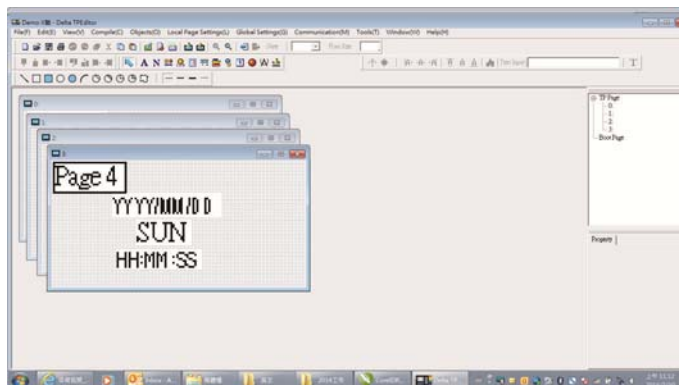

10 Auto-tuning Process

■ Flow Chart

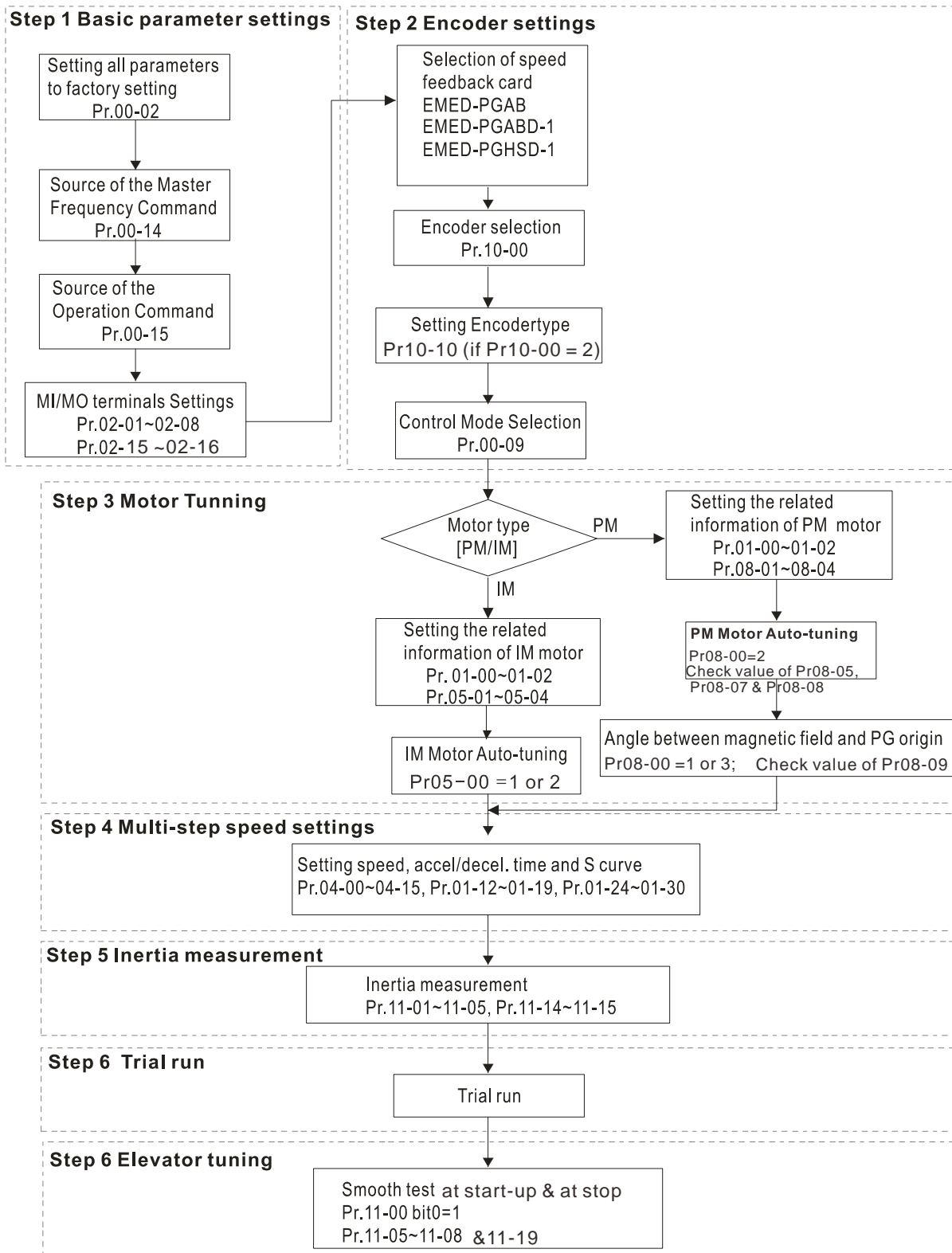

■ Explanations for the Auto-tuning Steps

Step1

Basic Parameters Settings

- Make sure that Pr.00-00 (identity code of the AC motor drive) corresponds with the nameplate indicated on the AC motor drive.

- Make sure that all parameters are reset to factory setting (Pr.00-02 is set to 9 or 10).

| | |
|-----------|--------------------------------------------------------------------------|
| Pr00-02 | 0: No function |
| Parameter | 1: Read only |
| Reset | 8: Keypad lock |
| | 9: All parameters are reset to factory settings (base frequency = 50Hz) |
| | 10: All parameters are reset to factory settings (base frequency = 60Hz) |

■

- Source of the Master Frequency Command: It is user-defined. (Pr.00-14)

■

| | |
|----------------------------------------|-------------------------------------------------------------|
| Pr00-14 | 1: RS-485 serial communication or digital keypad (KPC-CC01) |
| Source of the Master Frequency Command | 2: External analog input (Pr. 03-00) |
| | 3: Digital terminals input (Pr04-00 ~ Pr.04-15) |

■

- Source of the Operation Command: It is user-defined. (Pr.00-15)

■

| | |
|-----------------------------------|-------------------------------------------------------------|
| Pr00-15 | 1: External terminals |
| Source of the operation frequency | 2: RS-485 serial communication or digital keypad (KPC-CC01) |

- MI/MO External Terminal Settings:

Refer to Pr.02-01~Pr02-08 for setting of the external input terminals MI1~MI8.

NOTE: The factory setting of Pr.02-08 is 40 (Enable drive function).

Disable this function, if you don't need to use it.

| | |
|---------------------------------|----------------------------------------------------------|
| Settings of Pr02-01 to Prp02-08 | 0: No function |
| | 1: multi-step speed command 1 |
| | 2: multi-step speed command 2 |
| | 3: multi-step speed command 3 |
| | 4: multi-step speed command 4 |
| | 5: Reset |
| | 6: JOG command |
| | 7: Acceleration/ Deceleration Speed inhibit |
| | 8: the 1st, 2nd acceleration/deceleration time selection |
| | 9: the 3rd, 4th acceleration/deceleration time selection |
| | 10: EF input (07-28) |
| | 11: Reserved |
| | 12: Stop Output |
| | 13: Reserved |
| | 14: Reserved |
| | 15: Operation speed command form AUI1 |
| | 16: Reserved |
| | 17: operation speed command form AUI2 |
| | 18: Emergency stop (Pr07-28) |
| | 19~23: Reserved |
| | 24: FWD JOG command |

25: REV JOG command
 26: Reserved
 27: ASR1/ASR2 selection
 28: Emergency stop (EF1) (Motor coasts to stop)
 29-30: Reserved
 31: High torque bias (by Pr.07-21)
 32: Middle torque bias (by Pr.07-22)
 33: Low torque bias (by Pr.07-23)
 34-37: Reserved
 38: Disable write EEPROM function
 39: Torque command direction
 40: Enable drive function
 41: Detection for magnetic contactor
 42: Mechanical brake
 43: EPS function

Refer to Pr02-15 and Pr02-16 for the settings of MO1~MO8

Pr02-15~ 0: No function
 Pr02-16 1: Operation indication
 2: Operation speed attained
 3: Desired frequency attained 1 (Pr.02-25)
 4: Desired frequency attained 2 (Pr.02-27)
 5: Zero speed (frequency command)
 6: Zero speed with stop (frequency command)
 7: Over torque (OT1) (Pr.06-05~06-07)
 8: Over torque (OT2) (Pr.06-08~06-10)
 9: Drive ready
 10: User-defined Low-voltage Detection (LV)
 11: Malfunction indication
 12: Mechanical brake release (Pr.02-29, Pr.02-30)
 13: Overheat (Pr.06-14)
 14: Brake chopper signal
 15: Motor-controlled magnetic contactor output
 16: Slip error (oSL)
 17: Malfunction indication
 18: Reserved
 19: Brake chopper output error
 20: Warning output
 21: Over voltage warning
 22: Over-current stall prevention warning
 23: Over-voltage stall prevention warning
 24: Operation mode indication (Pr.00-15≠0)
 25: Forward command
 26: Reverse command
 27: Output when current \geq Pr.02-33
 28: Output when current $<$ Pr.02-33
 29: Output when frequency \geq Pr.02-34
 30: Output when frequency $<$ Pr.02-34
 31-32: Reserved
 33: Zero speed (actual output frequency)
 34: Zero speed with Stop (actual output frequency)
 35: Error output selection 1 (Pr.06-22)
 36: Error output selection 2 (Pr.06-23)
 37: Error output selection 3 (Pr.06-24)
 38: Error output selection 4 (Pr.06-25)
 39: Reserved
 40: Speed attained (including zero speed)
 41: Reserved
 42: STO output error

Step2

Encoder Settings

- Selection of speed feedback cards
 - Refer to CH07 Speed Feedback Card Selection. Delta provides 3 kinds of PG card for user to choose, including EMED-PGABD-1, EMED-PGHSD-1, EMED-PGAB-0.

| | |
|-------------------|-------------------------|
| Pr10-00 | 0: No function |
| Type of PG signal | 1: ABZ |
| | 2: ABZ+Hall |
| | 3: SIN/COS + Sinusoidal |
| | 4: SIN/COS + Endat |
| | 5: SIN/COS |
| | 6: SIN/COS + Hiperface |

- Encoder settings: Pr.10-01~Pr.10-02

Detection for the magnetic pole position of motor

The detection method will be different by the setting of Pr.10-00 PG Signal Type.

The detection methods: (refer to Pr.10-00)

- Setting 1 or 5: The AC motor drive will output short circuit to detect the position of the magnetic pole. At this moment, the motor will generate a little noise.
- Setting 2: The AC motor drive will detect the position of the magnetic pole by the UVW signal of PG.
- Setting 3: The AC motor drive will detect the position of the magnetic pole by the sine signal of PG.
- Setting 4: The AC motor drive will detect the position of the magnetic pole by the communication signal of PG.

| | |
|---------------|---------|
| Pr10-01 | 1~25000 |
| Encoder Pulse | |

Type of Encoder Input Setting. The setting of this parameter is normally 1. If the motor doesn't run at setting 1, change to setting 2.

| | |
|-------------------------------|---------------------------------------------------------------------------------------------------------------------------|
| Pr10-02 | 0: No function |
| Type of Encoder Input Setting | 1: Phase A leads in a forward run command and phase B leads in a reverse run command |
| | 2: Phase B leads in a forward run command and phase A leads in a reverse run command |
| | 3: Phase A is a pulse input and phase B is a direction input. (low input=reverse direction, high input=forward direction) |
| | 4: Phase A is a pulse input and phase B is a direction input. (low input=forward direction, high input=reverse direction) |
| | 5: Single-phase input |

Step 3

Motor tuning

- Setting the parameters according to the motor type (PM or IM)
- Motor Auto-tuning: When the Source of the Operation Command is set to digital keypad (Pr.00-15=2, refer to step 1)
- Control method: Please set Pr.00-09 to 8.

| | |
|------------------------------|-----------------------------------------|
| Pr00-09 Control Method | 0: V/f Control |
| | 1: V/f Control + Encoder (VFPG) |
| | 2: Sensorless vector control (SVC) |
| | 3: FOC vector control + Encoder (FOCPG) |
| | 4: Torque control + Encoder (TQCPG) |
| | 8: FOC PM control (FOCPM) |

- NOTE: Setting parameter by the motor type (PM or IM).
- Inputting the nameplate information on the motor into Pr.01-00~01-02

| | |
|-------------------------------------|----------------|
| Pr01-00 Maximum Output Frequency | 10.00~400.00Hz |
|-------------------------------------|----------------|

| | |
|-----------------------------------------------------------------------------------------|---------------|
| Pr01-01 1st Output Frequency Setting 1 (base frequency/ motor rated frequency) | 0.00~400.00Hz |
|-----------------------------------------------------------------------------------------|---------------|

| | |
|------------------------------------------------------------------------------------|------------------------------------------------------|
| Pr.01-02 1st Output Voltage Setting 1 (base voltage/ motor rated voltage) | 230V models: 0.0V~255.0V 460V models: 0.0V~510.0V |
|------------------------------------------------------------------------------------|------------------------------------------------------|

【IM (Induction Motor)】

- Motor Auto-tuning: When the Source of the Operation Command is set to digital keypad (Pr.00-15=2, refer to step 1) and setting Pr.05-00=2
-

| | |
|------------------------------|------------------------------------------------------------------|
| Pr05-00 Motor Auto Tuning | 0: No function |
| | 1: Rolling test (Rs, Rr, Lm, Lx, no-load current) , (Motor runs) |
| | 2: Static Test (Motor doesn't run) |

NOTE 1: It doesn't need to release the brake in this auto tuning operation. Please make sure that the electromagnetic valve is ON when it is used between the AC motor drive and motor. When Pr.05-00 is set to 2, no-load current of motor must be entered into Pr.05-05. The warning message "Auto tuning" will be displayed on the digital keypad during tuning until it is finished. Then, the measure result will be saved into Pr.05-06~Pr.05-09.

NOTE 2: It needs to finish motor auto tuning before measuring the angle between magnetic pole and PG origin.

| | |
|---------------------------------------|-------------------------|
| Pr05-01 Full-load Current of Motor | (40~120%) *00-01 Amps |
|---------------------------------------|-------------------------|

| | |
|---------------------------------|---------------|
| Pr05-02 Rated Power of Motor | 0.00~655.35kW |
|---------------------------------|---------------|

| | |
|--------------------------------------|---------|
| Pr05-03 Rated Speed of Motor(rpm) | 0~65535 |
|--------------------------------------|---------|

| | |
|-------------------------------------|-----|
| Pr05-04 Number of Motor Poles | 2~9 |
|-------------------------------------|-----|

【Permanent Magnet Motor】

- Motor Auto-tuning: When the Source of the Operation Command is set to digital keypad (Pr.00-15=2, refer to step 1) and setting Pr.08-00=2

| | |
|------------------------------|-----------------------------------------------------------------------------------------------------------------------------------------------------------------------------------------------------------------------|
| Pr08-00 Motor Auto Tuning | 0: No function 1: Only for the unloaded motor, auto measure the Angle between magnetic pole and PG origin (08-09) 2: For PM parameters 3: Auto measure the Angle between magnetic pole and PG origin (08-09) |
|------------------------------|-----------------------------------------------------------------------------------------------------------------------------------------------------------------------------------------------------------------------|

NOTE 1: It doesn't need to release the brake in this auto tuning operation. Please make sure that the electromagnetic valve is ON when it is used between the AC motor drive and motor. The warning message "Auto tuning" will be displayed on the digital keypad during tuning until it is finished. Then, the measure result will be saved into Pr.08-05 and Pr.08-07. (Pr.08-05 is Rs of Motor and Pr.08-07 is Lq of Motor)

NOTE 2: It is recommended to set Pr.08-00 to 1 (unloaded motor) for the most accurate calculation. If it needs to execute this function with loaded motor, please balance the carriage before execution.

When Pr.08-00=1, please note:

- When executing the function of auto measure the Angle between magnetic pole and PG origin, it is recommended to stop the carriage car at the middle level.
- Make sure that the electromagnetic valve and mechanical brake are OFF before executing this function.
- When Pr.08-00=1, please execute this function with unloaded motor to get the most accurate result. If it needs to execute this function with loaded motor, please balance the carriage before execution. Make sure the balance by releasing the brake manually before running. This balance will affect the accuracy and the accuracy will influence the power efficiency in driving the motor.

NOTE 3: If it doesn't allow balancing carriage in the measured environment, it can set Pr.08-00 to 3 for executing this function. It will have a difference of 15~30° by the different encoder type.

- When Pr.08-00 is set to 3, the driver will execute the function by the setting of Pr.10-00. The difference between Pr.08-00=3 and Pr.08-00=1 is it doesn't need to put the balanced carriage when Pr.08-00=3. Besides, the operation status of the motor will be as shown in the above table (Pr.10-00=1, 2, 3 and 5, the motor will run. Pr.10-00=4 and 6, the motor won't run)
- When Pr.08-00=3, please make sure if the setting of Pr.10-02 is correct. The incorrect setting will result in the wrong position of the magnetic pole and make the wrong angle between magnetic pole and PG origin.
-

NOTE 4: The warning message "Auto tuning" will be displayed on the digital keypad during tuning until it is finished. Then, the measure result will be saved into Pr.08-09.

NOTE 5: If the warning message "Auto Tuning Err" displayed on the digital keypad during tuning due to abnormal drive or human factor, please check if the wiring is correct. When the warning message "PG Fbk Error" displayed on the digital keypad, please change the setting of Pr.10-02 (for example: if it was set to 1, please change it to 2). When the warning message "PG Fbk Loss" is displayed on the digital keypad, please check the feedback of Z-phase pulse.

| | |
|----------------------------------------|----------------------|
| Pr.08-01 Full-load Current of Motor | (40~120%)*00-01 Amps |
| Pr.08-02 Rated power of Motor | 0.00~655.35 kW |
| Pr.08-03 Rated speed of Motor (rpm) | 0~65535 |
| Pr.08-04 Number of Motor Poles | 2~96 |

■ Measure the angle between magnetic pole and PG origin

To execute "RUN" by keypad or digital terminals:

1. Using digital keypad: setting Pr.08-00 to 1 and press "RUN" to execute "auto measure the angle between magnetic pole and PG origin". Please note that if the electromagnetic valve and brake are not controlled by the AC motor drive, please release it by manual.
2. Using external terminals: setting Pr.00-14=3 (frequency source) and Pr.00-15=1 (operation source). Please use "inspection" function to execute "auto measure the angle between magnetic pole and PG origin".

For the IM, it doesn't need to detect the position of the magnetic pole; this function (auto measure the Angle between magnetic pole and PG origin) doesn't have to be executed.

Measure the angle between magnetic pole and PG origin: Pr.08-00=1 or 3

| | |
|-------------------------------|------------------------------------------------------------------------------------------------------------------------------------------------------------------------------------------------------------------------------------------|
| Pr.08-00 Motor Auto tuning | <p>0: No function</p> <p>1: Only for the unloaded motor, auto measure the Angle between magnetic pole and PG origin (08-09)</p> <p>2: For PM parameters</p> <p>3: Auto measure the Angle between magnetic pole and PG origin (08-09)</p> |
|-------------------------------|------------------------------------------------------------------------------------------------------------------------------------------------------------------------------------------------------------------------------------------|

NOTE: The function of "auto measure the angle between magnetic pole and Pg origin" only can be enabled after finishing motor auto-tuning.

Step 4**Multi-Step Speed setting or Analog setting****(Do not wire the two settings at the same time)****A. Multi-step speed settings**

- Confirm the total speed steps (high speed, middle speed, low speed, creep, inspection and level auto-learning)
- Make sure that the setting of step speeds and the action of the corresponding terminals of multi-function input commands are correct.
- Setting multi-step speeds in Pr.04-00 to Pr.04-15

| | | |
|----------------------------------|---------------------------|---------------|
| Settings of Pr.04-00 to Pr.04-15 | Zero Step Speed Frequency | 0.00~400.00Hz |
| | 1st Step Speed Frequency | 0.00~400.00Hz |
| | 2nd Step Speed Frequency | 0.00~400.00Hz |
| | 3rd Step Speed Frequency | 0.00~400.00Hz |
| | 4th Step Speed Frequency | 0.00~400.00Hz |
| | 5th Step Speed Frequency | 0.00~400.00Hz |
| | 6th Step Speed Frequency | 0.00~400.00Hz |
| | 7th Step Speed Frequency | 0.00~400.00Hz |
| | 8th Step Speed Frequency | 0.00~400.00Hz |
| | 9th Step Speed Frequency | 0.00~400.00Hz |
| | 10th Step Speed Frequency | 0.00~400.00Hz |
| | 11th Step Speed Frequency | 0.00~400.00Hz |
| | 12th Step Speed Frequency | 0.00~400.00Hz |
| | 13th Step Speed Frequency | 0.00~400.00Hz |
| | 14th Step Speed Frequency | 0.00~400.00Hz |
| 15th Step Speed Frequency | 0.00~400.00Hz | |

NOTE: It is recommended to set the max. operating frequency to the half of max. operating frequency before confirming the setting of each step speed and the action of the corresponding terminals of multi-function input commands.

- Setting the acceleration/deceleration with Pr.01-23 and the setting 08 (the 1st, 2nd acceleration/deceleration time selection) and 09 (the 3rd, 4th acceleration/deceleration time selection) of multi-function input command Pr.02-01~02-08.
- Settings of acceleration/deceleration time: Pr.01-12~Pr.01-19

| | | |
|----------------------------------|--------------|-----------------|
| Settings of Pr.01-12 to Pr.01-19 | Accel Time 1 | 0.00~600.00 sec |
| | Decel Time 1 | 0.00~600.00 sec |
| | Accel Time 2 | 0.00~600.00 sec |
| | Decel Time 2 | 0.00~600.00 sec |
| | Accel Time 3 | 0.00~600.00 sec |
| | Decel Time 3 | 0.00~600.00 sec |
| | Accel Time 4 | 0.00~600.00 sec |
| | Decel Time 4 | 0.00~600.00 sec |

NOTE: it is recommended to set the Pr.01-31 (deceleration time) to the small value in the trial run and execute smooth test after all the actions are correct.

■ Settings of S curve: Pr.01-24~Pr.01-30

| | | |
|----------------------------------|--------------------------------------------|----------------------------------------------------------------------------------------|
| Settings of Pr.01-24 to Pr.01-30 | S-curve for Acceleration Departure Time S1 | 0.00~25.00 sec |
| | S-curve for Acceleration Arrival Time S2 | 0.00~25.00 sec |
| | S-curve for Deceleration Departure Time S3 | 0.00~25.00 sec |
| | S-curve for Deceleration Arrival Time S4 | 0.00~25.00 sec |
| | Mode Selection when Frequency < Fmin | 0: Output waiting 1: Zero-speed operation 2: Fmin (4th output frequency setting) |
| | Switch Frequency for S3/S4 Changes to S5 | 0.00~400.00Hz |
| | S-curve for Deceleration Arrival Time S5 | 0.00~25.00 sec |

NOTE: it is recommended to set the S curve time to 0 in trial run and execute smooth test after all the actions are correct.

B. Analog setting

1. Set Pr00-14=2, frequency command is assigned by the external analog signal.
2. Set Pr00-15 =1, operating command is assigned by the external terminals.
3. In order to work with the control terminal, set up Pr03-23 or Pr03-24 in accordance with the output mode of the controller
4. Set up Pr03-03, PR03-05 or Pr03-06 to work with the connecting port. Set F to display 0Hz when the motor drive is going to stop.

Step 5

Inertia: For synchronous motor, set Pr11-05 = 40%. For asynchronous motor, set Pr11-05 = 80%.

| | |
|----------------------------|--------|
| Pr.11-05 Inertial Ratio | 1~300% |
|----------------------------|--------|

Step 6**Trial run**

This step is used to trial run after finishing the settings of Step 1 to Step 5 to check if it runs normally after executing the inspection with the loaded motor. At the same time, please also check if the operations of multi-function output terminals is normal, such as the action of the brake release and electromagnetic valve correspond to the host controller.

It needs to check the switch between each step speed, current value, the noise in the carriage and noise source during operation.

Step 7

Elevator tuning

1. Setting Pr. 11-00 to bit 0=1

| | |
|----------------------------|------------------------------------------------------------------------------------------------------------------------------------------------------------------|
| Pr.11-00 System control | Bit 0=0: disable Bit 0=1: ASR Auto tuning, PDFF enable Bit 7=1: When position control is enabled, it doesn't need to set Pr.07-02 (DC Brake Current Level) |
|----------------------------|------------------------------------------------------------------------------------------------------------------------------------------------------------------|

2. Smooth test for general operation

- Adjust the setting of Pr.11-05

| | |
|----------------------------|--------|
| Pr.11-05 Inertial Ratio | 1~300% |
|----------------------------|--------|

- Adjust the settings of Pr.11-06 to Pr.11-08

| | | |
|----------------------------------|----------------------|--------|
| Settings of Pr.11-06 to Pr.11-08 | Zero-speed Bandwidth | 0~40Hz |
| | Low-speed Bandwidth | 0~40Hz |
| | High-speed Bandwidth | 0~40Hz |

3. Start-up adjustment (only for PM)

- Control by the zero-speed position

Setting Pr.11-00, 10-19, 10-22, 10-23, 02-29 and 10-24

| | |
|---------------------------------|---------------------------------------------------------------------------------------------------------------------------------------------------------------------------------------------------------------------------------------------------------------------------------------------------------------------------------------------------------------------|
| Pr.11-00 System control | Bit 0=0: disable Bit 0=1: ASR Auto tuning, PDFF enable Bit 7=1: When position control is enabled, it doesn't need to set Pr.07-02 (DC Brake Current Level) Bit 15=0: when power is applied, it will detect the position of magnetic pole again Bit 15=1: when power is applied, it will start from the magnetic pole position of previous power failure |
| Pr.10-19 Zero Speed Gain (P) | 0~655.00% |

NOTE: refer to the explanations in Pr.02-32

| | |
|------------------------------------------|-----------------|
| Pr.10-22 Operation Time of Zero Speed | 0.000~65.535sec |
|------------------------------------------|-----------------|

| | |
|---------------------------------------|-----------------|
| Pr.10-23 Filter Time of Zero Speed | 0.000~65.535sec |
|---------------------------------------|-----------------|

| | |
|-------------------------------------------|-------------------------------------------------------------------------------------------------------------|
| Pr.10-24 Time for Zero Speed Execution | 0: after the brake release set in Pr.02-29 1: after the brake signal input (Pr.02-01~02-08 is set to 42) |
|-------------------------------------------|-------------------------------------------------------------------------------------------------------------|

| | |
|-----------------------------------------------------------|------------------|
| Pr.02-29 Brake Release Delay Time when Elevator Starts | 0.000~65.000 Sec |
|-----------------------------------------------------------|------------------|

NOTE: When Pr.10-24=0, the zero speed control needs to be used with Pr.02-29. (Refer to the explanations in Pr.02-32)

■ Function of the preload input

Connect the preload signal to the external terminal of the AC motor drive (AUI1) and setting Pr.03-00=3, 07-19=1, 03-03, 03-06 and 03-09.

| | |
|-----------------------------------|--------------------------------------------------------------------------------------------------------------------------------------------------------------------------------------------------------------------------------------------------------------------------------------------------------------------------------------------------------|
| Pr.03-00 Analog Input 1 (AUI1) | 0: No function 1: Frequency command (torque limit under TQR control mode) 2: Torque command (torque limit under speed mode) 3: Torque compensation command 4-5: Reserved 6: P.T.C. thermistor input value 7: Positive torque limit 8: Negative torque limit 9: Regenerative torque limit 10: Positive/negative torque limit |
|-----------------------------------|--------------------------------------------------------------------------------------------------------------------------------------------------------------------------------------------------------------------------------------------------------------------------------------------------------------------------------------------------------|

| | |
|-------------------------------------|----------------------------------------------------------------------------------------------------------------------------------------------|
| Pr.07-19 Source of Torque Offset | 0: Disable 1: Analog input (Pr.03-00) 2: Torque offset setting (Pr.07-20) 3: Control by external terminal (by Pr.07-21 to Pr.07-23) |
|-------------------------------------|----------------------------------------------------------------------------------------------------------------------------------------------|

| | |
|----------------------------------------|---------------|
| Pr.03-03 Analog Input Bias 1 (AUI1) | -100.0~100.0% |
|----------------------------------------|---------------|

| | |
|------------------------------------------------|------------------------------------------------------------------------------------------------------------------------------------------------------------------------------|
| Pr.03-06 Positive/negative Bias Mode (AUI1) | 0: Zero bias 1: Lower than bias=bias 2: Greater than bias=bias 3: The absolute value of the bias voltage while serving as the center 4: Serve bias as the center |
|------------------------------------------------|------------------------------------------------------------------------------------------------------------------------------------------------------------------------------|

| | |
|----------------------------------------|---------------|
| Pr.03-09 Analog Input Gain 1 (AUI1) | -500.0~500.0% |
|----------------------------------------|---------------|

NOTE: Pr.03-03, 03-06 and 03-09 are used to adjust the analog input signal.

- 07-19: Source of torque offset
- 03-00~02: Analog input selections (AUI1/AUI2)
- 03-03~05: Analog input bias (AUI1/AUI2)
- 03-06~08: AUI1/AUI2 bias mode

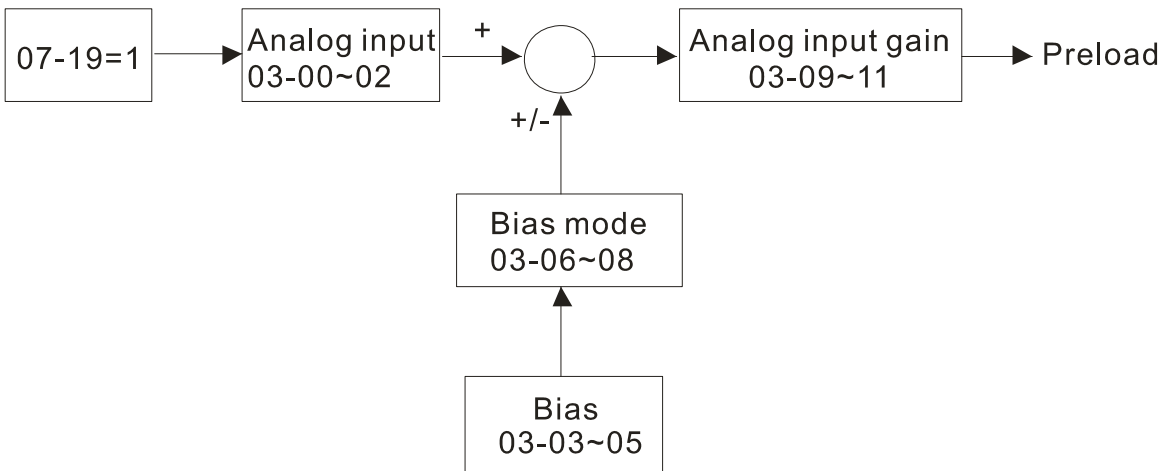

4. Setting of drive stop



Adjusting Pr.01-29, Pr.01-30, Pr.01-31 and Pr.11-19

| | |
|---------------------------------------------------------|-----------------|
| Pr.01-29 Switch Frequency for S3/S4 Changes to S5 | 0.00~400.00Hz |
| Pr.01-30 S-curve for Deceleration Arrival Time S5 | 0.00~25.00 sec |
| Pr.11-19 Zero-speed Holding Bandwidth | 0~40Hz |
| Pr.01-31 Deceleration Time | 0.00~600.00 sec |

11 Summary of Parameter Settings

This chapter provides summary of parameter settings for user to gather the parameter setting ranges, factory settings and set parameters. The parameters can be set, changed and reset by the digital keypad.

NOTE

- 1) : The parameter can be set during operation.
- 2) For more detail on parameters, please refer to Ch12 Description of Parameter Settings.
- 3)  indicates that the parameters or the setting value only applies on the Direct Docking Mode. The actual functions of each elevator controller vary from one to another. For more information, contact Delta.
- 4) The parameters described in this user manual are designed for multi-speed mode. The factory setting of direct docking mode are different from the factory setting described in this user manual. If you need to use the direct docking mode, contact Delta for more information.

00 Drive Parameters



NOTE

IM: Induction Motor; PM: Permanent Magnet Motor

| Pr. | Explanation | Setting Range | Factory Setting | VF | VFP | SVC | FOCPG | TQCPG | FOCPM |
|-------|--------------------------------------|------------------------------------------------------------------------------------------------------------------------------------------------------------------------------------------------------------------------------------------------------------------------------------------------------------------------------------------------------------------------------------------------------------------------------------------------------------------------------------|-----------------|-----------------------|-----------------------|-----------------------|-----------------------|-----------------------|-----------------------|
| | | | | <input type="radio"/> | <input type="radio"/> | <input type="radio"/> | <input type="radio"/> | <input type="radio"/> | <input type="radio"/> |
| 00-00 | Identity Code of AC Motor Drive | 108: 220V, 3HP (single phase) 110: 220V, 5HP (Single phase) 8: 230V, 3HP 10: 230V, 5HP 11: 460 V, 5HP (4.0kW) 12: 230V, 7.5HP 13: 460V, 7.5HP 14: 230V, 10HP 15: 460V, 10HP 16: 230V, 15HP 17: 460V, 15HP 18: 230V, 20HP 19: 460V, 20HP 20: 230V, 25HP 21: 460V, 25HP 22: 230V, 30HP 23: 460V, 30HP 24: 230V, 40HP 25: 460V, 40HP 26: 230V, 50HP 27: 460V, 50HP 29: 460V, 60HP 31: 460V, 75HP 33: 460V, 100HP | Read Only | <input type="radio"/> | <input type="radio"/> | <input type="radio"/> | <input type="radio"/> | <input type="radio"/> | <input type="radio"/> |
| 00-01 | Display AC Motor Drive Rated Current | Display by models | Read only | <input type="radio"/> | <input type="radio"/> | <input type="radio"/> | <input type="radio"/> | <input type="radio"/> | <input type="radio"/> |
| 00-02 | Parameter Reset | 0: No function 1: Read only | 0 | <input type="radio"/> | <input type="radio"/> | <input type="radio"/> | <input type="radio"/> | <input type="radio"/> | <input type="radio"/> |

| | | | | | | | | | | |
|---|-------|----------------------------------------------------------------------------------------------------------------------------------------------------------------------------------------------------------|---------------------------------------------------------------------------------------------------------------------------------------------------------------------------------------------------------------------------------------------------------------------------------------------------------------------------------------------------------------------------------------------------------------------------------------------------------------------------------------------------------------------------------------------------------------------------------------------------------------------------------------------------------------------------------------------------------------------------------------------------------------------------------------------------------------------------------------------------------------------------------------------------------------------------------------------------------------|---|-----------------------|-----------------------|-----------------------|-----------------------|-----------------------|-----------------------|
| | | 5 : Direct docking mode only ◆ 8: No function 9: All parameters are reset to factory settings(base frequency is 50Hz) 10: All parameters are reset to factory settings (base frequency is 60Hz) | | | | | | | | |
| ✓ | 00-03 | Start-up Display Selection | 0: Frequency command 1: Output frequency 2: DC BUS voltage 3: Output current 4: Output voltage 5: User defined (00-04) | 0 | <input type="radio"/> | <input type="radio"/> | <input type="radio"/> | <input type="radio"/> | <input type="radio"/> | <input type="radio"/> |
| ✓ | 00-04 | Content of Multi-function Display | 0: Display output current (A) (Unit: Amps) 1: Reserved 2: Display actual output frequency (H.) (Unit: Hz) 3: Display DC-BUS voltage (v) (Unit: Vdc) 4: Display output voltage (E) (Unit: Vac) 5: Display output power angle (n) (Unit: deg) 6: Display output power in kW (P) (Unit: kW) 7: Display actual motor speed rpm (r) (Unit: rpm) 8: Display estimate output torque % (t) (Unit: %) 9: Display PG feedback (G) (refer to Pr.10-00,10-01) (Unit: PLS) 10: Display PID feedback (b) (Unit: %) 11: Display AUI1 in % (1.) (Unit: %) 12: Reserved 13: Display AUI2 in % (2.) (Unit: %) 14: Display the temperature of heat sink In °C (c.) (Unit: °C). 15: Display the temperature of IGBT In °C (c.) (Unit: °C). 16: The status of digital input (ON/OFF) (i) 17: The status of digital output (ON/OFF) (o) 18: Multi-step speed (S) 19: The corresponding CPU pin status of digital input (d) | 0 | <input type="radio"/> | <input type="radio"/> | <input type="radio"/> | <input type="radio"/> | <input type="radio"/> | <input type="radio"/> |

| | | | | | | | | | | |
|---|-------|-------------------------------------------------------------------------------------------------------------------------------------------------------------------------------------------------------------------------------------------------------------------------------------------------------------------------------------------------------------------------------------------------------------------------------------------------------------------------------------------------------------------------------------------------------------------------------------------------------------------------------------------------|--------------------------------------------------------------------------------------------------------------------------------------------------------------------------------------------------------|------|-----------------------|-----------------------|-----------------------|-----------------------|-----------------------|-----------------------|
| | | 20: The corresponding CPU pin status of digital output (0.) 21~23: Reserved 24: AC output voltage when error occurred 25: DC-side voltage when error occurred 26: Motor's frequency when error occurred 27: Output current when error occurred 28: Output frequency when error occurred 29: Frequency command when error occurred 30: Output power when error occurred 31: Output torque when error occurred 32: Input terminal status when error occurred 33: Output terminal status when error occurred 34: Status of motor drive when error occurred 35: Display MI status & MO status on LED keypad. | | | | | | | | |
| ✓ | 00-05 | User-Defined Coefficient K | Digit 4: decimal point number (0 to 3) Digit 3-0: 40 to 9999 | 0 | <input type="radio"/> | <input type="radio"/> | <input type="radio"/> | <input type="radio"/> | <input type="radio"/> | <input type="radio"/> |
| | 00-06 | Software Version | READ ONLY | #. # | <input type="radio"/> | <input type="radio"/> | <input type="radio"/> | <input type="radio"/> | <input type="radio"/> | <input type="radio"/> |
| ✓ | 00-07 | Password Input | 1 to 9998 and 10000 to 65535 0 to 2: times of wrong password | 0 | <input type="radio"/> | <input type="radio"/> | <input type="radio"/> | <input type="radio"/> | <input type="radio"/> | <input type="radio"/> |
| ✓ | 00-08 | Password Set | 1 to 9998 and 10000 to 65535 0: No password set or successful input in Pr.00-07 1: Password has been set | 0 | <input type="radio"/> | <input type="radio"/> | <input type="radio"/> | <input type="radio"/> | <input type="radio"/> | <input type="radio"/> |
| | 00-09 | Control Method | 0: V/f Control 1: V/f Control + Encoder (VFPG) 2: Sensorless vector control (SVC) 3: FOC vector control + Encoder (FOCPG) 4: Torque control + Encoder (TQCPG) 8: FOC PM control (FOCPM) | 0 | <input type="radio"/> | <input type="radio"/> | <input type="radio"/> | <input type="radio"/> | <input type="radio"/> | <input type="radio"/> |
| ✓ | 00-10 | Speed Unit | 0: Hz 1: m/s 2: ft./s 3 : Direct docking mode only ◆ | 0 | <input type="radio"/> | <input type="radio"/> | <input type="radio"/> | <input type="radio"/> | <input type="radio"/> | <input type="radio"/> |
| | 00-11 | Output Direction Selection | 0: FWD: counterclockwise, REV: clockwise 1: FWD: clockwise, REV: counterclockwise | 0 | <input type="radio"/> | <input type="radio"/> | <input type="radio"/> | <input type="radio"/> | <input type="radio"/> | <input type="radio"/> |
| ✓ | 00-12 | Carrier Frequency | 2~15KHz | 12 | <input type="radio"/> | <input type="radio"/> | <input type="radio"/> | <input type="radio"/> | <input type="radio"/> | <input type="radio"/> |
| ✓ | 00-13 | Auto Voltage Regulation (AVR) Function | 0: Enable AVR 1: Disable AVR 2: Disable AVR when deceleration stop | 0 | <input type="radio"/> | <input type="radio"/> | <input type="radio"/> | <input type="radio"/> | <input type="radio"/> | <input type="radio"/> |
| ✓ | 00-14 | Source of the Master Frequency Command | 1: RS-485 serial communication or digital keypad (KPC-CC01) 2: External analog input (Pr. 03-00) 3: Digital terminals input (Pr. 04-00~04-15) 4 : Direct docking mode only ◆ | 1 | <input type="radio"/> | <input type="radio"/> | <input type="radio"/> | <input type="radio"/> | <input type="radio"/> | <input type="radio"/> |
| ✓ | 00-15 | Source of the Operation Command | 1: External terminals 2: RS-485 serial communication or digital keypad (KPC-CC01) | 1 | <input type="radio"/> | <input type="radio"/> | <input type="radio"/> | <input type="radio"/> | <input type="radio"/> | <input type="radio"/> |

01 Basic Parameters

| Pr. | Explanation | Setting Range | Factory Setting | V/F | V/FPG | SVC | FOCPG | TQCPG | FOCPM |
|---------|------------------------------------------------------------------------------|----------------------------------------------------------------------------------------|-----------------|--------------------------|--------------------------|--------------------------|--------------------------|--------------------------|--------------------------|
| | | | | <input type="checkbox"/> | <input type="checkbox"/> | <input type="checkbox"/> | <input type="checkbox"/> | <input type="checkbox"/> | <input type="checkbox"/> |
| 01-00 | Maximum Output Frequency | 10.00~400.00Hz | 60.00/ 50.00 | <input type="checkbox"/> | <input type="checkbox"/> | <input type="checkbox"/> | <input type="checkbox"/> | <input type="checkbox"/> | <input type="checkbox"/> |
| 01-01 | 1st Output Frequency Setting 1 (base frequency / motor's rated frequency) | 0.00~400.00Hz | 60.00/ 50.00 | <input type="checkbox"/> | <input type="checkbox"/> | <input type="checkbox"/> | <input type="checkbox"/> | <input type="checkbox"/> | <input type="checkbox"/> |
| 01-02 | 1st Output Voltage Setting 1 (base voltage/ motor's rated voltage) | 230V series: 0.0V~255.0V 460V series: 0.0V~510.0V | 220.0 440.0 | <input type="checkbox"/> | <input type="checkbox"/> | <input type="checkbox"/> | <input type="checkbox"/> | <input type="checkbox"/> | <input type="checkbox"/> |
| 01-03 | 2 nd Output Frequency Setting 1 | 0.00~400.00Hz | 0.50 | <input type="checkbox"/> | <input type="checkbox"/> | | | | |
| ✓ 01-04 | 2 nd Output Voltage Setting 1 | 230V series: 0.0V~255.0V 460V series: 0.0V~510.0V | 5.0 10.0 | <input type="checkbox"/> | <input type="checkbox"/> | | | | |
| 01-05 | 3 rd Output Frequency Setting 1 | 0.00~400.00Hz | 0.50 | <input type="checkbox"/> | <input type="checkbox"/> | | | | |
| ✓ 01-06 | 3 rd Output Voltage Setting 1 | 230V series: 0.0V~255.0V 460V series: 0.0V~510.0V | 5.0 10.0 | <input type="checkbox"/> | <input type="checkbox"/> | | | | |
| 01-07 | 4 th Output Frequency Setting 1 | 0.00~400.00Hz | 0.00 | <input type="checkbox"/> | <input type="checkbox"/> | <input type="checkbox"/> | <input type="checkbox"/> | <input type="checkbox"/> | |
| ✓ 01-08 | 4 th Output Voltage Setting 1 | 230V series: 0.0V~255.0V 460V series: 0.0V~510.0V | 5.0 10.0 | <input type="checkbox"/> | <input type="checkbox"/> | | | | |
| 01-09 | Starting Frequency | 0.00~400.00Hz | 0.50 | <input type="checkbox"/> | <input type="checkbox"/> | <input type="checkbox"/> | <input type="checkbox"/> | | |
| ✓ 01-10 | Output Frequency Upper Limit | 0.00~400.00Hz | 120.00 | <input type="checkbox"/> | <input type="checkbox"/> | <input type="checkbox"/> | <input type="checkbox"/> | | <input type="checkbox"/> |
| ✓ 01-11 | Output Frequency Lower Limit | 0.00~400.00Hz | 0.00 | <input type="checkbox"/> | <input type="checkbox"/> | <input type="checkbox"/> | <input type="checkbox"/> | | <input type="checkbox"/> |
| ✓ 01-12 | Accel Time 1 | 0.00~600.00 sec. | 3.00 | <input type="checkbox"/> | <input type="checkbox"/> | <input type="checkbox"/> | <input type="checkbox"/> | | <input type="checkbox"/> |
| ✓ 01-13 | Decel Time 1 | 0.00~600.00 sec | 2.00 | <input type="checkbox"/> | <input type="checkbox"/> | <input type="checkbox"/> | <input type="checkbox"/> | | <input type="checkbox"/> |
| ✓ 01-14 | Accel Time 2 | 0.00~600.00 sec | 3.00 | <input type="checkbox"/> | <input type="checkbox"/> | <input type="checkbox"/> | <input type="checkbox"/> | | <input type="checkbox"/> |
| ✓ 01-15 | Decel Time 2 | 0.00~600.00 sec | 2.00 | <input type="checkbox"/> | <input type="checkbox"/> | <input type="checkbox"/> | <input type="checkbox"/> | | <input type="checkbox"/> |
| ✓ 01-16 | Accel Time 3 | 0.00~600.00 sec | 3.00 | <input type="checkbox"/> | <input type="checkbox"/> | <input type="checkbox"/> | <input type="checkbox"/> | | <input type="checkbox"/> |
| ✓ 01-17 | Decel Time 3 | 0.00~600.00 sec | 2.00 | <input type="checkbox"/> | <input type="checkbox"/> | <input type="checkbox"/> | <input type="checkbox"/> | | <input type="checkbox"/> |
| ✓ 01-18 | Accel Time 4 | 0.00~600.00 sec | 3.00 | <input type="checkbox"/> | <input type="checkbox"/> | <input type="checkbox"/> | <input type="checkbox"/> | | <input type="checkbox"/> |
| ✓ 01-19 | Decel Time 4 | 0.00~600.00 sec | 2.00 | <input type="checkbox"/> | <input type="checkbox"/> | <input type="checkbox"/> | <input type="checkbox"/> | | <input type="checkbox"/> |
| ✓ 01-20 | JOG Acceleration Time | 0.00~600.00 sec | 1.00 | <input type="checkbox"/> | <input type="checkbox"/> | <input type="checkbox"/> | <input type="checkbox"/> | | <input type="checkbox"/> |
| ✓ 01-21 | JOG Deceleration Time | 0.00~600.00 sec | 1.00 | <input type="checkbox"/> | <input type="checkbox"/> | <input type="checkbox"/> | <input type="checkbox"/> | | <input type="checkbox"/> |
| ✓ 01-22 | JOG Frequency | 0.00~400.00Hz | 6.00 | <input type="checkbox"/> | <input type="checkbox"/> | <input type="checkbox"/> | <input type="checkbox"/> | <input type="checkbox"/> | <input type="checkbox"/> |
| ✓ 01-23 | Switch Frequency between 1st/4th Accel/ Decel | 0.00~400.00Hz | 0.00 | <input type="checkbox"/> | <input type="checkbox"/> | <input type="checkbox"/> | <input type="checkbox"/> | | <input type="checkbox"/> |
| ✓ 01-24 | S-curve for Acceleration Departure Time S1 | 0.00~25.00 sec | 1.00 | <input type="checkbox"/> | <input type="checkbox"/> | <input type="checkbox"/> | <input type="checkbox"/> | | <input type="checkbox"/> |
| ✓ 01-25 | S-curve for Acceleration Arrival Time S2 | 0.00~25.00 sec | 1.00 | <input type="checkbox"/> | <input type="checkbox"/> | <input type="checkbox"/> | <input type="checkbox"/> | | <input type="checkbox"/> |
| ✓ 01-26 | S-curve for Deceleration Departure Time S3 | 0.00~25.00sec. | 1.00 | <input type="checkbox"/> | <input type="checkbox"/> | <input type="checkbox"/> | <input type="checkbox"/> | | <input type="checkbox"/> |
| ✓ 01-27 | S-curve for Deceleration Arrival Time S4 | 0.00~25.00sec. | 1.00 | <input type="checkbox"/> | <input type="checkbox"/> | <input type="checkbox"/> | <input type="checkbox"/> | | <input type="checkbox"/> |
| 01-28 | Mode of Selection when Frequency < Fmin | 0: Output waiting 1: Zero-speed operation 2: Fmin (4th output frequency setting) | 1 | <input type="checkbox"/> | <input type="checkbox"/> | <input type="checkbox"/> | | | |
| ✓ 01-29 | Switch Frequency for S3/S4 Changes to S5 | 0.00~400.00Hz | 0.00 | <input type="checkbox"/> | <input type="checkbox"/> | <input type="checkbox"/> | <input type="checkbox"/> | | <input type="checkbox"/> |

| | | | | | | | | | | |
|---|-------|------------------------------------------------------|-----------------|------|-----------------------|-----------------------|-----------------------|-----------------------|-----------------------|-----------------------|
| ↗ | 01-30 | S-curve for Deceleration Arrival Time S5 | 0.00~25.00sec. | 1.00 | <input type="radio"/> | <input type="radio"/> | <input type="radio"/> | <input type="radio"/> | <input type="radio"/> | <input type="radio"/> |
| ↗ | 01-31 | Deceleration Time when Operating without RUN Command | 0.00~600.00sec. | 2.00 | <input type="radio"/> | <input type="radio"/> | <input type="radio"/> | <input type="radio"/> | <input type="radio"/> | <input type="radio"/> |
| | 01-32 | Direct docking mode only ◆ | | | <input type="radio"/> | <input type="radio"/> | <input type="radio"/> | <input type="radio"/> | <input type="radio"/> | <input type="radio"/> |

02 Digital Input/ Output Parameters

| Pr. | Explanation | Setting Range | Factory Setting | VF | VFG | SVC | FOCPG | TQCPG | FOCPM |
|-------------------------------------|------------------------------------------------------------------------------------|-----------------------------------------------------------------------------------------------------------------------------------------------------------------------------------------|-----------------------|-----------------------|-----------------------|-----------------------|-----------------------|-----------------------|-----------------------|
| | | | | | | | | | |
| 02-00 | 2-wire/3-wire Operation Control | 0: FWD/STOP, REV/STOP 1: FWD/STOP, REV/STOP (Line Start Lockout) 2: RUN/STOP, REV/FWD 3: RUN/STOP, REV/FWD (Line Start Lockout) 4: 3-wire 5: 3-wire (Line Start Lockout) | 0 | <input type="radio"/> | <input type="radio"/> | <input type="radio"/> | <input type="radio"/> | <input type="radio"/> | <input type="radio"/> |
| 02-01 | Multi-Function Input Command 1 (MI1) (it is Stop terminal for 3-wire operation) | 0: no function | 1 | <input type="radio"/> | <input type="radio"/> | <input type="radio"/> | <input type="radio"/> | <input type="radio"/> | <input type="radio"/> |
| | | 1: multi-step speed command 1 | | <input type="radio"/> | <input type="radio"/> | <input type="radio"/> | <input type="radio"/> | <input type="radio"/> | <input type="radio"/> |
| 02-02 | Multi-Function Input Command 2 (MI2) | 2: multi-step speed command 2 | 2 | <input type="radio"/> | <input type="radio"/> | <input type="radio"/> | <input type="radio"/> | <input type="radio"/> | <input type="radio"/> |
| 02-03 | Multi-Function Input Command 3 (MI3) | 3: multi-step speed command 3 | 3 | <input type="radio"/> | <input type="radio"/> | <input type="radio"/> | <input type="radio"/> | <input type="radio"/> | <input type="radio"/> |
| 02-04 | Multi-Function Input Command 4 (MI4) | 4: multi-step speed command 4 | 4 | <input type="radio"/> | <input type="radio"/> | <input type="radio"/> | <input type="radio"/> | <input type="radio"/> | <input type="radio"/> |
| 02-05 | Multi-Function Input Command 5 (MI5) | 5: Reset | 0 | <input type="radio"/> | <input type="radio"/> | <input type="radio"/> | <input type="radio"/> | <input type="radio"/> | <input type="radio"/> |
| 02-06 | Multi-Function Input Command 6 (MI6) | 6: JOG command | 0 | <input type="radio"/> | <input type="radio"/> | <input type="radio"/> | <input type="radio"/> | <input type="radio"/> | <input type="radio"/> |
| 02-07 | Multi-Function Input Command 7 (MI7) | 7: acceleration/ deceleration speed inhibit | 0 | <input type="radio"/> | <input type="radio"/> | <input type="radio"/> | <input type="radio"/> | <input type="radio"/> | <input type="radio"/> |
| 02-08 | Multi-Function Input Command 8 (MI8) | 8: the 1st, 2nd acceleration/deceleration time selection | 40 | <input type="radio"/> | <input type="radio"/> | <input type="radio"/> | <input type="radio"/> | <input type="radio"/> | <input type="radio"/> |
| | | 9: the 3rd, 4th acceleration/deceleration time selection | | <input type="radio"/> | <input type="radio"/> | <input type="radio"/> | <input type="radio"/> | <input type="radio"/> | <input type="radio"/> |
| | | 10: EF input (07-28) | | <input type="radio"/> | <input type="radio"/> | <input type="radio"/> | <input type="radio"/> | <input type="radio"/> | <input type="radio"/> |
| | | 11: Reserved | | <input type="radio"/> | <input type="radio"/> | <input type="radio"/> | <input type="radio"/> | <input type="radio"/> | <input type="radio"/> |
| | | 12: Stop output | | <input type="radio"/> | <input type="radio"/> | <input type="radio"/> | <input type="radio"/> | <input type="radio"/> | <input type="radio"/> |
| | | 13~14: Reserved | | <input type="radio"/> | <input type="radio"/> | <input type="radio"/> | <input type="radio"/> | <input type="radio"/> | <input type="radio"/> |
| | | 15: operation speed command form AUI1 | | <input type="radio"/> | <input type="radio"/> | <input type="radio"/> | <input type="radio"/> | <input type="radio"/> | <input type="radio"/> |
| | | 16: Reserved | | <input type="radio"/> | <input type="radio"/> | <input type="radio"/> | <input type="radio"/> | <input type="radio"/> | <input type="radio"/> |
| | | 17: Operation speed command form AUI2 | | <input type="radio"/> | <input type="radio"/> | <input type="radio"/> | <input type="radio"/> | <input type="radio"/> | <input type="radio"/> |
| | | 18: Emergency Stop (07-28) | | <input type="radio"/> | <input type="radio"/> | <input type="radio"/> | <input type="radio"/> | <input type="radio"/> | <input type="radio"/> |
| | | 19~23: Reserved | | <input type="radio"/> | <input type="radio"/> | <input type="radio"/> | <input type="radio"/> | <input type="radio"/> | <input type="radio"/> |
| | | 24: FWD JOG command | | <input type="radio"/> | <input type="radio"/> | <input type="radio"/> | <input type="radio"/> | <input type="radio"/> | <input type="radio"/> |
| | | 25: REV JOG command | | <input type="radio"/> | <input type="radio"/> | <input type="radio"/> | <input type="radio"/> | <input type="radio"/> | <input type="radio"/> |
| | | 26: Reserved | | <input type="radio"/> | <input type="radio"/> | <input type="radio"/> | <input type="radio"/> | <input type="radio"/> | <input type="radio"/> |
| | | 27: ASR1/ASR2 selection | | <input type="radio"/> | <input type="radio"/> | <input type="radio"/> | <input type="radio"/> | <input type="radio"/> | <input type="radio"/> |
| | | 28: Emergency stop (EF1) (Motor coasts to stop) | | <input type="radio"/> | <input type="radio"/> | <input type="radio"/> | <input type="radio"/> | <input type="radio"/> | <input type="radio"/> |
| | | 29-30: Reserved | | <input type="radio"/> | <input type="radio"/> | <input type="radio"/> | <input type="radio"/> | <input type="radio"/> | <input type="radio"/> |
| | | 31: High torque bias (by Pr.07-21) | | <input type="radio"/> | <input type="radio"/> | <input type="radio"/> | <input type="radio"/> | <input type="radio"/> | <input type="radio"/> |
| | | 32: Middle torque bias (by Pr.07-22) | | <input type="radio"/> | <input type="radio"/> | <input type="radio"/> | <input type="radio"/> | <input type="radio"/> | <input type="radio"/> |
| | | 33: Low torque bias (by Pr.07-23) | | <input type="radio"/> | <input type="radio"/> | <input type="radio"/> | <input type="radio"/> | <input type="radio"/> | <input type="radio"/> |
| | | 34-37: Reserved | | <input type="radio"/> | <input type="radio"/> | <input type="radio"/> | <input type="radio"/> | <input type="radio"/> | <input type="radio"/> |
| 38: Disable write EEPROM function | <input type="radio"/> | <input type="radio"/> | <input type="radio"/> | <input type="radio"/> | <input type="radio"/> | <input type="radio"/> | | | |
| 39: Torque command direction | <input type="radio"/> | <input type="radio"/> | <input type="radio"/> | <input type="radio"/> | <input type="radio"/> | <input type="radio"/> | | | |
| 40: Enable drive function | <input type="radio"/> | <input type="radio"/> | <input type="radio"/> | <input type="radio"/> | <input type="radio"/> | <input type="radio"/> | | | |
| 41: Detection of magnetic contactor | <input type="radio"/> | <input type="radio"/> | <input type="radio"/> | <input type="radio"/> | <input type="radio"/> | <input type="radio"/> | | | |
| 42: Mechanical brake 1 | <input type="radio"/> | <input type="radio"/> | <input type="radio"/> | <input type="radio"/> | <input type="radio"/> | <input type="radio"/> | | | |
| 43: EPS function | <input type="radio"/> | <input type="radio"/> | <input type="radio"/> | <input type="radio"/> | <input type="radio"/> | <input type="radio"/> | | | |

| | | | | | | | | | | |
|---|-------|-------------------------------------------------|--------------------------------------------------------------------------|-------|---|---|---|---|---|---|
| | | 44: Mechanical brake 2 | | | | | | | | |
| | | 45~51: Direct docking mode only ◆ | | | | | | | | |
| ↗ | 02-09 | Digital Input Response Time | 0.001~ 30.000sec. | 0.005 | ○ | ○ | ○ | ○ | ○ | ○ |
| ↗ | 02-10 | Digital Input Operation Direction | 0~65535 | 0 | ○ | ○ | ○ | ○ | ○ | ○ |
| ↗ | 02-11 | Multi-function Output 1: RA, RB, RC (Relay1) | 0: No function | 11 | ○ | ○ | ○ | ○ | ○ | ○ |
| | | | 1: Operation indication | | ○ | ○ | ○ | ○ | ○ | ○ |
| ↗ | 02-12 | Multi-function Output 2: MRA, MRB, MRC (Relay2) | 2: Operation speed attained | 1 | ○ | ○ | ○ | ○ | ○ | ○ |
| | | | 3: Desired frequency attained 1 (Pr.02-25) | | ○ | ○ | ○ | ○ | | ○ |
| ↗ | 02-13 | Multi-function Output 3: R1A, R12C (Relay3) | 4: Desired frequency attained 2 (Pr.02-27) | 0 | ○ | ○ | ○ | ○ | | ○ |
| ↗ | 02-14 | Multi-function Output 4: R2A, R12C (Relay4) | 5: Zero speed (frequency command) | 0 | ○ | ○ | ○ | ○ | | ○ |
| ↗ | 02-15 | Multi-function Output 5: (MO1) | 6: Zero speed with stop (frequency command) | 0 | ○ | ○ | ○ | ○ | | ○ |
| ↗ | 02-16 | Multi-function Output 6: (MO2) | 7: Over torque (OT1) (Pr.06-05~06-07) | 0 | ○ | ○ | ○ | ○ | ○ | ○ |
| | | | 8: Over torque (OT2) (Pr.06-08~06-10) | 0 | ○ | ○ | ○ | ○ | ○ | ○ |
| | | | 9: Drive ready | 0 | ○ | ○ | ○ | ○ | ○ | ○ |
| | | | 10: User-defined Low-voltage Detection (LV) | 0 | ○ | ○ | ○ | ○ | ○ | ○ |
| | | | 11: Malfunction indication | 0 | ○ | ○ | ○ | ○ | ○ | ○ |
| | | | 12: Mechanical brake release (Pr.02-29, Pr.02-30) | 0 | ○ | ○ | ○ | ○ | ○ | ○ |
| | | | 13: Overheat (Pr.06-14) | 0 | ○ | ○ | ○ | ○ | ○ | ○ |
| | | | 14: Brake chopper signal | | ○ | ○ | ○ | ○ | ○ | ○ |
| | | | 15: Motor-controlled magnetic contactor output | | ○ | ○ | ○ | ○ | ○ | ○ |
| | | | 16: Slip error (oSL) | | ○ | ○ | ○ | ○ | | ○ |
| | | | 17: Malfunction indication 1 | 0 | ○ | ○ | ○ | ○ | ○ | ○ |
| | | | 18: Reserved | | | | | | | |
| | | | 19: Brake chopper output error | | ○ | ○ | ○ | ○ | ○ | ○ |
| | | | 20: Warning output | | ○ | ○ | ○ | ○ | ○ | ○ |
| | | | 21: Over voltage warning | | ○ | ○ | ○ | ○ | ○ | ○ |
| | | | 22: Over-current stall prevention warning | | ○ | ○ | ○ | | | |
| | | | 23: Over-voltage stall prevention warning | | ○ | ○ | ○ | ○ | ○ | ○ |
| | | | 24: Operation mode indication (Pr.00-15≠0 and PU LED on KPC-CC01 is off) | | ○ | ○ | ○ | ○ | ○ | ○ |
| | | | 25: Forward command | | ○ | ○ | ○ | ○ | ○ | ○ |
| | | | 26: Reverse command | | ○ | ○ | ○ | ○ | ○ | ○ |
| | | | 27: Output when current ≥ Pr.02-33 | | ○ | ○ | ○ | ○ | ○ | ○ |
| | | | 28: Output when current < Pr.02-33 | | ○ | ○ | ○ | ○ | ○ | ○ |
| | | | 29: Output when frequency ≥ Pr.02-34 | | ○ | ○ | ○ | ○ | ○ | ○ |
| | | | 30: Output when frequency < Pr.02-34 | | ○ | ○ | ○ | ○ | ○ | ○ |
| | | | 31: Power generation direction and status verify | | ○ | ○ | ○ | ○ | ○ | ○ |
| | | | 32: Power generation direction | | ○ | ○ | ○ | ○ | ○ | ○ |
| | | | 33: Zero speed (actual output frequency) | | ○ | ○ | ○ | ○ | | ○ |
| | | | 34: Zero speed with Stop (actual output frequency) | | ○ | ○ | ○ | ○ | | ○ |
| | | | 35: Fault output option 1 (Pr.06-22) | | ○ | ○ | ○ | ○ | ○ | ○ |
| | | | 36: Fault output option 2 (Pr.06-23) | | ○ | ○ | ○ | ○ | ○ | ○ |
| | | | 37: Fault output option 3 (Pr.06-24) | | ○ | ○ | ○ | ○ | ○ | ○ |
| | | | 38: Fault output option 4 (Pr.06-25) | | ○ | ○ | ○ | ○ | ○ | ○ |
| | | | 39: Reserved | | | | | | | |
| | | | 40: Speed attained (including zero speed) | | ○ | ○ | ○ | ○ | | ○ |
| | | | 41: Reserved | | | | | | | |
| | | | 42: STO Output Error | | | | | | | |
| | | | 43~44: Direct docking mode only ◆ | | | | | | | |

| | | | | | | | | | | |
|---|--------------|--------------------------------------------------------------|-------------------------------------------------------|-------------|---|---|---|---|---|---|
| | | 45: Reserved | | | | | | | | |
| | | 46: Indicator of Retrying while a fault has occurred | | | | | | | | |
| | | 47: Direct docking mode only ◆ | | | | | | | | |
| | 02-17~ 02-22 | Reserved | | | | | | | | |
| ✓ | 02-23 | Multi-output Direction | 0~65535 | 0 | ○ | ○ | ○ | ○ | ○ | ○ |
| | 02-24 | Serial Start Signal Selection | 0: by FWD/REV; 1: by Enable | 0 | ○ | ○ | ○ | ○ | | ○ |
| ✓ | 02-25 | Desired Frequency Attained 1 | 0.00~400.00Hz | 60.00/50.00 | ○ | ○ | ○ | ○ | | ○ |
| ✓ | 02-26 | The Width of the Desired Frequency Attained 1 | 0.00~400.00Hz | 2.00 | ○ | ○ | ○ | ○ | | ○ |
| ✓ | 02-27 | Desired Frequency Attained 2 | 0.00~400.00Hz | 60.00/50.00 | ○ | ○ | ○ | ○ | | ○ |
| ✓ | 02-28 | The Width of the Desired Frequency Attained 2 | 0.00~400.00Hz | 2.00 | ○ | ○ | ○ | ○ | | ○ |
| | 02-29 | Brake Release Delay Time when Elevator Starts | 0.000~65.000sec. | 0.250 | ○ | ○ | ○ | ○ | ○ | ○ |
| | 02-30 | Brake Engage Delay Time when Elevator Stops | 0.000~65.000sec. | 0.250 | ○ | ○ | ○ | ○ | ○ | ○ |
| ✓ | 02-31 | Turn On Delay of Magnetic Contactor between Drive and Motor | 0.010~65.000 sec. | 0.200 | ○ | ○ | ○ | ○ | ○ | ○ |
| ✓ | 02-32 | Turn Off Delay of Magnetic Contactor between Drive and Motor | 0.010~65.000 sec. | 0.200 | ○ | ○ | ○ | ○ | ○ | ○ |
| ✓ | 02-33 | Output Current Level Setting for External Terminals | 0~100% | 0 | ○ | ○ | ○ | ○ | ○ | ○ |
| ✓ | 02-34 | Output Boundary for External Terminals | 0.00~+400.00Hz (it is motor speed when using with PG) | 0.00 | ○ | ○ | ○ | ○ | ○ | ○ |
| ✓ | 02-35 | Detection Time of Mechanical Brake | 0.00~10.00sec. | 0.00 | ○ | ○ | ○ | ○ | ○ | ○ |
| ✓ | 02-36 | Detection Time of Contactor | 0.00~10.00sec. | 0.00 | ○ | ○ | ○ | ○ | ○ | ○ |
| | 02-37 | Check Torque Output Function | 0: Enable 1: Disable | 0 | ○ | ○ | ○ | ○ | ○ | ○ |

03 Analog Input/ Output Parameters

| Pr. | Explanation | Setting Range | Factory Setting | VF | VFG | SVC | FOCPG | TQCPG | FOCPM | |
|---------|------------------------------------|-------------------------------------------------------------------------------------------------------------------------------------------------------------------------------------------|-----------------------|-----------------------|-----------------------|-----------------------|-----------------------|-----------------------|-----------------------|-----------------------|
| | | | | | | | | | | |
| ✓ 03-00 | Analog Input 1 (AUI1) | 0: No function | 1 | <input type="radio"/> | <input type="radio"/> | <input type="radio"/> | <input type="radio"/> | <input type="radio"/> | <input type="radio"/> | |
| ✓ 03-01 | Reserved | 1: Frequency command (torque limit under TQR control mode) | | | | | | | | |
| ✓ 03-02 | Analog Input 3 (AUI2) | 2: Torque command (torque limit under speed mode) | 0 | | | | | <input type="radio"/> | | |
| | | 3: Preload Input | | <input type="radio"/> | <input type="radio"/> | <input type="radio"/> | <input type="radio"/> | <input type="radio"/> | <input type="radio"/> | |
| | | 4-5: Reserved | | | | | | | | |
| | | 6: P.T.C. thermistor input value | | <input type="radio"/> | <input type="radio"/> | <input type="radio"/> | <input type="radio"/> | <input type="radio"/> | <input type="radio"/> | |
| | | 7: Positive torque limit | | | | | <input type="radio"/> | | <input type="radio"/> | |
| | | 8: Negative torque limit | | | | | <input type="radio"/> | | <input type="radio"/> | |
| | | 9: Regenerative torque limit | | | | | <input type="radio"/> | | <input type="radio"/> | |
| | | 10: Positive/negative torque limit | | | | | <input type="radio"/> | | <input type="radio"/> | |
| ✓ 03-03 | Analog Input Bias 1 (AUI1) | -100.0~100.0% | | 0.0 | <input type="radio"/> | <input type="radio"/> | <input type="radio"/> | <input type="radio"/> | <input type="radio"/> | <input type="radio"/> |
| ✓ 03-04 | Reserved | | | | | | | | | |
| ✓ 03-05 | Analog Input Bias 3 (AUI2) | -100.0~100.0% | 0.0 | <input type="radio"/> | <input type="radio"/> | <input type="radio"/> | <input type="radio"/> | <input type="radio"/> | <input type="radio"/> | |
| ✓ 03-06 | Positive/negative Bias Mode (AUI1) | 0: Zero bias | 0 | <input type="radio"/> | <input type="radio"/> | <input type="radio"/> | <input type="radio"/> | <input type="radio"/> | <input type="radio"/> | |
| ✓ 03-07 | Reserved | 1: Serve bias as the center, lower than bias=bias | | | | | | | | |
| ✓ 03-08 | Positive/negative Bias Mode (AUI2) | 2: Serve bias as the center, greater than bias=bias 3: The absolute value of the bias voltage while serving as the center (single polar) 4: Serve bias as the center (single polar) | | 0 | <input type="radio"/> | <input type="radio"/> | <input type="radio"/> | <input type="radio"/> | <input type="radio"/> | <input type="radio"/> |
| ✓ 03-09 | Analog Input Gain 1 (AUI1) | 0.0~500.0% | 100.0 | <input type="radio"/> | <input type="radio"/> | <input type="radio"/> | <input type="radio"/> | <input type="radio"/> | <input type="radio"/> | |
| ✓ 03-10 | Reserved | | | | | | | | | |
| ✓ 03-11 | Analog Input Gain 3 (AUI2) | 0.0~500.0% | 100.0 | <input type="radio"/> | <input type="radio"/> | <input type="radio"/> | <input type="radio"/> | <input type="radio"/> | <input type="radio"/> | |
| ✓ 03-12 | Analog Input Delay Time (AUI1) | 0.00~2.00sec. | 0.01 | <input type="radio"/> | <input type="radio"/> | <input type="radio"/> | <input type="radio"/> | <input type="radio"/> | <input type="radio"/> | |
| ✓ 03-13 | Reserved | | | | | | | | | |
| ✓ 03-14 | Analog Input Filter Time (AUI2) | 0.00~2.00sec. | 0.01 | <input type="radio"/> | <input type="radio"/> | <input type="radio"/> | <input type="radio"/> | <input type="radio"/> | <input type="radio"/> | |
| ✓ 03-15 | Reserved | | | | | | | | | |
| ✓ 03-16 | Reserved | | | | | | | | | |
| ✓ 03-17 | Analog Output Selection 1 | 0: Output frequency (Hz) | 0 | <input type="radio"/> | <input type="radio"/> | <input type="radio"/> | <input type="radio"/> | <input type="radio"/> | <input type="radio"/> | |
| | | 1: Frequency command (Hz) | | <input type="radio"/> | <input type="radio"/> | <input type="radio"/> | <input type="radio"/> | <input type="radio"/> | <input type="radio"/> | |
| | | 2: Motor speed (RPM) | | <input type="radio"/> | <input type="radio"/> | <input type="radio"/> | <input type="radio"/> | <input type="radio"/> | <input type="radio"/> | |
| | | 3: Output current (rms) | | <input type="radio"/> | <input type="radio"/> | <input type="radio"/> | <input type="radio"/> | <input type="radio"/> | <input type="radio"/> | |
| | | 4: Output voltage | | <input type="radio"/> | <input type="radio"/> | <input type="radio"/> | <input type="radio"/> | <input type="radio"/> | <input type="radio"/> | |
| | | 5: DC Bus Voltage | | <input type="radio"/> | <input type="radio"/> | <input type="radio"/> | <input type="radio"/> | <input type="radio"/> | <input type="radio"/> | |
| | | 6: Power factor angle | | <input type="radio"/> | <input type="radio"/> | <input type="radio"/> | <input type="radio"/> | <input type="radio"/> | <input type="radio"/> | |
| | | 7: Power factor | | <input type="radio"/> | <input type="radio"/> | <input type="radio"/> | <input type="radio"/> | <input type="radio"/> | <input type="radio"/> | |
| | | 8: Output torque | | <input type="radio"/> | <input type="radio"/> | <input type="radio"/> | <input type="radio"/> | <input type="radio"/> | <input type="radio"/> | |
| | | 9: AUI1 | | <input type="radio"/> | <input type="radio"/> | <input type="radio"/> | <input type="radio"/> | <input type="radio"/> | <input type="radio"/> | |
| | | 10: ACI | | | | | | | | |
| | | 11: AUI2 | | <input type="radio"/> | <input type="radio"/> | <input type="radio"/> | <input type="radio"/> | <input type="radio"/> | <input type="radio"/> | |
| | | 12: q-axis current | | <input type="radio"/> | <input type="radio"/> | <input type="radio"/> | <input type="radio"/> | <input type="radio"/> | <input type="radio"/> | |
| | | 13: q-axis feedback value | | <input type="radio"/> | <input type="radio"/> | <input type="radio"/> | <input type="radio"/> | <input type="radio"/> | <input type="radio"/> | |
| | | 14: d-axis current | | <input type="radio"/> | <input type="radio"/> | <input type="radio"/> | <input type="radio"/> | <input type="radio"/> | <input type="radio"/> | |
| | | 15: d-axis feedback value | | <input type="radio"/> | <input type="radio"/> | <input type="radio"/> | <input type="radio"/> | <input type="radio"/> | <input type="radio"/> | |
| | | 16: q-axis voltage | | <input type="radio"/> | <input type="radio"/> | <input type="radio"/> | <input type="radio"/> | <input type="radio"/> | <input type="radio"/> | |
| | | 17: d-axis voltage | <input type="radio"/> | <input type="radio"/> | <input type="radio"/> | <input type="radio"/> | <input type="radio"/> | <input type="radio"/> | | |

| | | | | | | | | | |
|---|-------|----------------------------------------|------------------------------------------------------------------------------------------------------------------|-----------------------|-----------------------|-----------------------|-----------------------|-----------------------|-----------------------|
| | | 18: Torque command | | <input type="radio"/> | <input type="radio"/> | <input type="radio"/> | <input type="radio"/> | <input type="radio"/> | <input type="radio"/> |
| | | 19-20: Reserved | | | | | | | |
| | | 21: Power Output | | <input type="radio"/> | <input type="radio"/> | <input type="radio"/> | <input type="radio"/> | <input type="radio"/> | <input type="radio"/> |
| ↗ | 03-18 | Analog Output Gain 1 | 0~200.0% | 100.0 | <input type="radio"/> | <input type="radio"/> | <input type="radio"/> | <input type="radio"/> | <input type="radio"/> |
| ↗ | 03-19 | Analog Output Value in REV Direction 1 | 0: Absolute value in REV direction 1: Output 0V in REV direction 2: Enable output voltage in REV direction | 0 | <input type="radio"/> | <input type="radio"/> | <input type="radio"/> | <input type="radio"/> | <input type="radio"/> |
| ↗ | 03-20 | Analog Output Selection 2 | 0: Output frequency (Hz) | 0 | <input type="radio"/> | <input type="radio"/> | <input type="radio"/> | <input type="radio"/> | <input type="radio"/> |
| | | 1: Frequency command (Hz) | | | <input type="radio"/> | <input type="radio"/> | <input type="radio"/> | <input type="radio"/> | <input type="radio"/> |
| | | 2: Motor speed (RPM) | | | <input type="radio"/> | <input type="radio"/> | <input type="radio"/> | <input type="radio"/> | <input type="radio"/> |
| | | 3: Output current (rms) | | | <input type="radio"/> | <input type="radio"/> | <input type="radio"/> | <input type="radio"/> | <input type="radio"/> |
| | | 4: Output voltage | | | <input type="radio"/> | <input type="radio"/> | <input type="radio"/> | <input type="radio"/> | <input type="radio"/> |
| | | 5: DC Bus Voltage | | | <input type="radio"/> | <input type="radio"/> | <input type="radio"/> | <input type="radio"/> | <input type="radio"/> |
| | | 6: Power factor | | | <input type="radio"/> | <input type="radio"/> | <input type="radio"/> | <input type="radio"/> | <input type="radio"/> |
| | | 7: Power | | | <input type="radio"/> | <input type="radio"/> | <input type="radio"/> | <input type="radio"/> | <input type="radio"/> |
| | | 8: Output torque | | | <input type="radio"/> | <input type="radio"/> | <input type="radio"/> | <input type="radio"/> | <input type="radio"/> |
| | | 9: AVI | | | <input type="radio"/> | <input type="radio"/> | <input type="radio"/> | <input type="radio"/> | <input type="radio"/> |
| | | 10: ACI | | | | | | | |
| | | 11: AUI | | | <input type="radio"/> | <input type="radio"/> | <input type="radio"/> | <input type="radio"/> | <input type="radio"/> |
| | | 12: q-axis current | | | <input type="radio"/> | <input type="radio"/> | <input type="radio"/> | <input type="radio"/> | <input type="radio"/> |
| | | 13: q-axis feedback value | | | <input type="radio"/> | <input type="radio"/> | <input type="radio"/> | <input type="radio"/> | <input type="radio"/> |
| | | 14: d-axis current | | | <input type="radio"/> | <input type="radio"/> | <input type="radio"/> | <input type="radio"/> | <input type="radio"/> |
| | | 15: d-axis feedback value | | | <input type="radio"/> | <input type="radio"/> | <input type="radio"/> | <input type="radio"/> | <input type="radio"/> |
| | | 16: q-axis voltage | | | <input type="radio"/> | <input type="radio"/> | <input type="radio"/> | <input type="radio"/> | <input type="radio"/> |
| | | 17: d-axis voltage | | | <input type="radio"/> | <input type="radio"/> | <input type="radio"/> | <input type="radio"/> | <input type="radio"/> |
| | | 18: Torque command | | | <input type="radio"/> | <input type="radio"/> | <input type="radio"/> | <input type="radio"/> | <input type="radio"/> |
| | | 19-20: Reserved | | | | | | | |
| | | 21: Power Output | | | <input type="radio"/> | <input type="radio"/> | <input type="radio"/> | <input type="radio"/> | <input type="radio"/> |
| ↗ | 03-21 | Analog Output Gain 2 | 0~200.0% | 100.0 | <input type="radio"/> | <input type="radio"/> | <input type="radio"/> | <input type="radio"/> | <input type="radio"/> |
| ↗ | 03-22 | Analog Output Value in REV Direction 2 | 0: Absolute value in REV direction 1: Output 0V in REV direction 2: Enable output voltage in REV direction | 0 | <input type="radio"/> | <input type="radio"/> | <input type="radio"/> | <input type="radio"/> | <input type="radio"/> |
| | 03-23 | Analog Input Type (AUI1) | 0: Bipolar (±10V) 1: Unipolar (0-10V) | 0 | <input type="radio"/> | <input type="radio"/> | <input type="radio"/> | <input type="radio"/> | <input type="radio"/> |
| | 03-24 | Analog Input Type (AUI2) | 0: Bipolar (±10V) 1: Unipolar (0-10V) | 0 | <input type="radio"/> | <input type="radio"/> | <input type="radio"/> | <input type="radio"/> | <input type="radio"/> |

04 Multi-Step Speed Parameters

| Pr. | Explanation | Setting Range | Factory Setting | VF | VFG | SVC | FOCPG | TQCPG | FOCPM |
|---------------------|----------------------------|---------------|-----------------|-----------------------|-----------------------|-----------------------|-----------------------|-----------------------|-----------------------|
| | | | | <input type="radio"/> | <input type="radio"/> | <input type="radio"/> | <input type="radio"/> | <input type="radio"/> | <input type="radio"/> |
| ↗ 04-00 | Zero Step Speed Frequency | 0.00~400.00Hz | 0.00 | <input type="radio"/> | <input type="radio"/> | <input type="radio"/> | <input type="radio"/> | <input type="radio"/> | <input type="radio"/> |
| ↗ 04-01 | 1st Step Speed Frequency | 0.00~400.00Hz | 0.00 | <input type="radio"/> | <input type="radio"/> | <input type="radio"/> | <input type="radio"/> | <input type="radio"/> | <input type="radio"/> |
| ↗ 04-02 | 2nd Step Speed Frequency | 0.00~400.00Hz | 0.00 | <input type="radio"/> | <input type="radio"/> | <input type="radio"/> | <input type="radio"/> | <input type="radio"/> | <input type="radio"/> |
| ↗ 04-03 | 3rd Step Speed Frequency | 0.00~400.00Hz | 0.00 | <input type="radio"/> | <input type="radio"/> | <input type="radio"/> | <input type="radio"/> | <input type="radio"/> | <input type="radio"/> |
| ↗ 04-04 | 4th Step Speed Frequency | 0.00~400.00Hz | 0.00 | <input type="radio"/> | <input type="radio"/> | <input type="radio"/> | <input type="radio"/> | <input type="radio"/> | <input type="radio"/> |
| ↗ 04-05 | 5th Step Speed Frequency | 0.00~400.00Hz | 0.00 | <input type="radio"/> | <input type="radio"/> | <input type="radio"/> | <input type="radio"/> | <input type="radio"/> | <input type="radio"/> |
| ↗ 04-06 | 6th Step Speed Frequency | 0.00~400.00Hz | 0.00 | <input type="radio"/> | <input type="radio"/> | <input type="radio"/> | <input type="radio"/> | <input type="radio"/> | <input type="radio"/> |
| ↗ 04-07 | 7th Step Speed Frequency | 0.00~400.00Hz | 0.00 | <input type="radio"/> | <input type="radio"/> | <input type="radio"/> | <input type="radio"/> | <input type="radio"/> | <input type="radio"/> |
| ↗ 04-08 | 8th Step Speed Frequency | 0.00~400.00Hz | 0.00 | <input type="radio"/> | <input type="radio"/> | <input type="radio"/> | <input type="radio"/> | <input type="radio"/> | <input type="radio"/> |
| ↗ 04-09 | 9th Step Speed Frequency | 0.00~400.00Hz | 0.00 | <input type="radio"/> | <input type="radio"/> | <input type="radio"/> | <input type="radio"/> | <input type="radio"/> | <input type="radio"/> |
| ↗ 04-10 | 10th Step Speed Frequency | 0.00~400.00Hz | 0.00 | <input type="radio"/> | <input type="radio"/> | <input type="radio"/> | <input type="radio"/> | <input type="radio"/> | <input type="radio"/> |
| ↗ 04-11 | 11th Step Speed Frequency | 0.00~400.00Hz | 0.00 | <input type="radio"/> | <input type="radio"/> | <input type="radio"/> | <input type="radio"/> | <input type="radio"/> | <input type="radio"/> |
| ↗ 04-12 | 12th Step Speed Frequency | 0.00~400.00Hz | 0.00 | <input type="radio"/> | <input type="radio"/> | <input type="radio"/> | <input type="radio"/> | <input type="radio"/> | <input type="radio"/> |
| ↗ 04-13 | 13th Step Speed Frequency | 0.00~400.00Hz | 0.00 | <input type="radio"/> | <input type="radio"/> | <input type="radio"/> | <input type="radio"/> | <input type="radio"/> | <input type="radio"/> |
| ↗ 04-14 | 14th Step Speed Frequency | 0.00~400.00Hz | 0.00 | <input type="radio"/> | <input type="radio"/> | <input type="radio"/> | <input type="radio"/> | <input type="radio"/> | <input type="radio"/> |
| ↗ 04-15 | 15th Step Speed Frequency | 0.00~400.00Hz | 0.00 | <input type="radio"/> | <input type="radio"/> | <input type="radio"/> | <input type="radio"/> | <input type="radio"/> | <input type="radio"/> |
| 04-16 ~ 04-99 | Direct docking mode only ◆ | | | | | | | | |

05 IM Parameters

| Pr. | Explanation | Setting Range | Factory Setting | VF | VFP | SVC | FOCPG | TQCPG | FOCPM |
|---------|--------------------------------------------------------|---------------------------------------------------------------------------------------|-----------------|-----------------------|-----------------------|-----------------------|-----------------------|-----------------------|-----------------------|
| | | | | | | | | | |
| 05-00 | Motor Auto Tuning | 0: No function 1: Rolling test (Rs, Rr, Lm, Lx, no-load current) 2: Static test | 0 | <input type="radio"/> | | | | | |
| 05-01 | Full-load Current of Motor | (40~120%) *00-01 Amps | ### | <input type="radio"/> | <input type="radio"/> | <input type="radio"/> | <input type="radio"/> | <input type="radio"/> | |
| 05-02 | Rated power of Motor | 0.00~655.35kW | ### | | | <input type="radio"/> | <input type="radio"/> | <input type="radio"/> | |
| 05-03 | Rated speed of Motor (rpm) | 0~65535 | 1710 | | <input type="radio"/> | <input type="radio"/> | <input type="radio"/> | <input type="radio"/> | |
| 05-04 | Number of Motor Poles | 2~48 | 4 | <input type="radio"/> | <input type="radio"/> | <input type="radio"/> | <input type="radio"/> | <input type="radio"/> | |
| 05-05 | No-load Current of Motor | 0~ Pr05-01 <factory setting> | ### | | <input type="radio"/> | <input type="radio"/> | <input type="radio"/> | <input type="radio"/> | |
| 05-06 | Rs of Motor | 0.000~65.535Ω | 0.000 | | | <input type="radio"/> | <input type="radio"/> | <input type="radio"/> | |
| 05-07 | Rr of Motor | 0.000~65.535Ω | 0.000 | | | <input type="radio"/> | <input type="radio"/> | <input type="radio"/> | |
| 05-08 | Lm of Motor | 0.0~6553.5mH | 0.0 | | | <input type="radio"/> | <input type="radio"/> | <input type="radio"/> | |
| 05-09 | Lx of Motor | 0.0~6553.5mH | 0.0 | | | <input type="radio"/> | <input type="radio"/> | <input type="radio"/> | |
| ✓ 05-10 | Torque Compensation Time Constant | 0.001~10.000sec. | 0.020 | | | <input type="radio"/> | | | |
| ✓ 05-11 | Slip Compensation Time Constant | 0.001~10.000sec. | 0.100 | | | <input type="radio"/> | | | |
| ✓ 05-12 | Torque Compensation Gain | 0~10 | 0 | <input type="radio"/> | <input type="radio"/> | | | | |
| ✓ 05-13 | Slip Compensation Gain | 0.00~10.00 | 0.00 | <input type="radio"/> | <input type="radio"/> | <input type="radio"/> | | | |
| ✓ 05-14 | Slip Deviation Level | 0~1000% (0: disable) | 0 | | <input type="radio"/> | <input type="radio"/> | <input type="radio"/> | | |
| ✓ 05-15 | Detection Time of Slip Deviation | 0.0~10.0sec. | 1.0 | | <input type="radio"/> | <input type="radio"/> | <input type="radio"/> | | |
| ✓ 05-16 | Over Slip Treatment | 0: Warn and keep operation 1: Fault and ramp to stop 2: Fault and coast to stop | 0 | | <input type="radio"/> | <input type="radio"/> | <input type="radio"/> | | |
| ✓ 05-17 | Hunting Gain | 0~10000 (0: disable) | 2000 | <input type="radio"/> | <input type="radio"/> | <input type="radio"/> | | | |
| 05-18 | Accumulative Motor Operation Time (Min.) | 00~1439 | 00 | <input type="radio"/> | <input type="radio"/> | <input type="radio"/> | <input type="radio"/> | <input type="radio"/> | <input type="radio"/> |
| 05-19 | Accumulative Motor Operation Time (day) | 00~65535 | 00 | <input type="radio"/> | <input type="radio"/> | <input type="radio"/> | <input type="radio"/> | <input type="radio"/> | <input type="radio"/> |
| ✓ 05-20 | Core Loss Compensation | 0~250% | 10 | | | <input type="radio"/> | | | |
| 05-21 | Accumulative Drive Power-on Time (Min.) | 00~1439 | 00 | <input type="radio"/> | <input type="radio"/> | <input type="radio"/> | <input type="radio"/> | <input type="radio"/> | <input type="radio"/> |
| 05-22 | Accumulative Drive Power-on Time (day) | 00~65535 | 00 | <input type="radio"/> | <input type="radio"/> | <input type="radio"/> | <input type="radio"/> | <input type="radio"/> | <input type="radio"/> |
| 05-23 | Slip compensation gain % (electricity generating mode) | 0.0~100.0 % | 0.0 | <input type="radio"/> | | <input type="radio"/> | | | |
| 05-24 | Slip compensation gain % (electric mode) | 0.0~100.0 % | 0.0 | <input type="radio"/> | | <input type="radio"/> | | | |

06 Protection Parameters

| Pr. | Explanation | Setting Range | Factory Setting | VF | VFP | SVC | FOCPG | TQCPG | FOCPM |
|---------|----------------------------------------------------------------------|------------------------------------------------------------------------------------------------------------------------------------------------------------------------------------------------------------------------------------------------------------------------------------------------------------------------------------------------------------------------|-----------------|-----------------------|-----------------------|-----------------------|-----------------------|-----------------------|-----------------------|
| | | | | | | | | | |
| ✓ 06-00 | Low Voltage Level | 160.0~220.0Vdc 320.0~440.0Vdc | 180.0 360.0 | <input type="radio"/> | <input type="radio"/> | <input type="radio"/> | <input type="radio"/> | <input type="radio"/> | <input type="radio"/> |
| ✓ 06-01 | Phase-loss protection | 0: Warm and keep operation 1: Fault and ramp to stop 2: Fault and coast to stop | 2 | <input type="radio"/> | <input type="radio"/> | <input type="radio"/> | <input type="radio"/> | <input type="radio"/> | <input type="radio"/> |
| ✓ 06-02 | Over-Current Stall Prevention during Acceleration | 00: disable 00~250% (rated current of the motor drive) | 00 | <input type="radio"/> | <input type="radio"/> | <input type="radio"/> | | | |
| ✓ 06-03 | Over-current Stall Prevention during Operation | 00: disable 00~250% (rated current of the motor drive) | 00 | <input type="radio"/> | <input type="radio"/> | <input type="radio"/> | | | |
| ✓ 06-04 | Accel. / Decel. Time Selection of Stall Prevention at constant speed | 0: by current accel/decel time 1: by the 1st accel/decel time 2: by the 2nd accel/decel time 3: by the 3rd accel/decel time 4: by the 4th accel/decel time 5: by auto accel/decel time | 0 | <input type="radio"/> | <input type="radio"/> | <input type="radio"/> | | | |
| ✓ 06-05 | Over-torque Detection Selection (OT1) | 0: disable 1: over-torque detection during constant speed operation, continue to operate after detection 2: over-torque detection during constant speed operation, stop operation after detection 3: over-torque detection during operation, continue to operate after detection 4: over-torque detection during operation, stop operation after detection | 0 | <input type="radio"/> | <input type="radio"/> | <input type="radio"/> | <input type="radio"/> | <input type="radio"/> | <input type="radio"/> |
| ✓ 06-06 | Over-torque Detection Level (OT1) | 10~250% (rated current of the motor drive) | 150 | <input type="radio"/> | <input type="radio"/> | <input type="radio"/> | <input type="radio"/> | <input type="radio"/> | <input type="radio"/> |
| ✓ 06-07 | Over-torque Detection Time (OT1) | 0.1~60.0sec. | 0.1 | <input type="radio"/> | <input type="radio"/> | <input type="radio"/> | <input type="radio"/> | <input type="radio"/> | <input type="radio"/> |
| ✓ 06-08 | Over-torque Detection Selection (OT2) | 0: disable 1: over-torque detection during constant speed operation, continue to operate after detection 2: over-torque detection during constant speed operation, stop operation after detection 3: over-torque detection during operation, continue to operate after detection 4: over-torque detection during operation, stop operation after detection | 0 | <input type="radio"/> | <input type="radio"/> | <input type="radio"/> | <input type="radio"/> | <input type="radio"/> | <input type="radio"/> |
| ✓ 06-09 | Over-torque Detection Level (OT2) | 10~250% (rated current of the motor drive) | 150 | <input type="radio"/> | <input type="radio"/> | <input type="radio"/> | <input type="radio"/> | <input type="radio"/> | <input type="radio"/> |
| ✓ 06-10 | Over-torque Detection Time (OT2) | 0.1~60.0sec. | 0.1 | <input type="radio"/> | <input type="radio"/> | <input type="radio"/> | <input type="radio"/> | <input type="radio"/> | <input type="radio"/> |
| ✓ 06-11 | Current Limit | 0~250% (rated current of the motor drive) | 200 | | | | <input type="radio"/> | <input type="radio"/> | <input type="radio"/> |
| ✓ 06-12 | Electronic Thermal Relay Selection | 0: Inverter motor 1: Standard motor 2: Disable | 2 | <input type="radio"/> | <input type="radio"/> | <input type="radio"/> | <input type="radio"/> | <input type="radio"/> | <input type="radio"/> |
| ✓ 06-13 | Electronic Thermal Characteristic | 30.0~600.0sec. | 60.0 | <input type="radio"/> | <input type="radio"/> | <input type="radio"/> | <input type="radio"/> | <input type="radio"/> | <input type="radio"/> |
| ✓ 06-14 | Heat Sink Over-heat (OH) Warning | 0.0~110.0°C | 90.0 | <input type="radio"/> | <input type="radio"/> | <input type="radio"/> | <input type="radio"/> | <input type="radio"/> | <input type="radio"/> |
| ✓ 06-15 | Stall Prevention Limit Level | 0~100% (Refer to Pr06-02, Pr06-03) | 50 | <input type="radio"/> | <input type="radio"/> | <input type="radio"/> | | | |
| 06-16 | Present Fault Record | 0: No fault | 0 | <input type="radio"/> | <input type="radio"/> | <input type="radio"/> | <input type="radio"/> | <input type="radio"/> | <input type="radio"/> |

| | | | | | | | | | |
|-------|---------------------------------|-----------------------------------------------------------------------------------------------------------------------------------------------------------------------------------------------------------------------------------------------------------------------------------------------------------------------------------------------------------------------------------------------------------------------------------------------------------------------------------------------------------------------------------------------------------------------------------------------------------------------------------------------------------------------------------------------------------------------------------------------------------------------------------------------------------------------------------------------------------------------------------------------------------------------------------------------------------------------------------------------------------------------------------------------------------------------------------------------------------------------------------------------|---|-----------------------|-----------------------|-----------------------|-----------------------|-----------------------|-----------------------|
| 06-17 | Second Most Recent Fault Record | 1: Over-current during acceleration (ocA) | 0 | <input type="radio"/> | <input type="radio"/> | <input type="radio"/> | <input type="radio"/> | <input type="radio"/> | <input type="radio"/> |
| 06-18 | Third Most Recent Fault Record | 2: Over-current during deceleration (ocd) | 0 | <input type="radio"/> | <input type="radio"/> | <input type="radio"/> | <input type="radio"/> | <input type="radio"/> | <input type="radio"/> |
| 06-19 | Fourth Most Recent Fault Record | 3: Over-current during constant speed (ocn) | 0 | <input type="radio"/> | <input type="radio"/> | <input type="radio"/> | <input type="radio"/> | <input type="radio"/> | <input type="radio"/> |
| 06-20 | Fifth Most Recent Fault Record | 4: Ground fault (GFF) | 0 | <input type="radio"/> | <input type="radio"/> | <input type="radio"/> | <input type="radio"/> | <input type="radio"/> | <input type="radio"/> |
| 06-21 | Sixth Most Recent Fault Record | 5: IGBT short-circuit (occ) 6: Over-current at stop (ocS) 7: Over-voltage during acceleration (ovA) 8: Over-voltage during deceleration (ovd) 9: Over-voltage during constant speed (ovn) 10: Over-voltage at stop (ovS) 11: Low-voltage during acceleration (LvA) 12: Low-voltage during deceleration (Lvd) 13: Low-voltage during constant speed (Lvn) 14: Low-voltage at stop (LvS) 15: Input Phase loss (PHL) 16: IGBT over-heat (oH1) 17: Bulk capacitors over-heat (oH2) 18: Abnormal IGBT temperature detected (tH1o) 19: Abnormal bulk capacitor temperature detected (tH2o) 20: Unusual cooling fan operation (FAn) | 0 | <input type="radio"/> | <input type="radio"/> | <input type="radio"/> | <input type="radio"/> | <input type="radio"/> | <input type="radio"/> |
| | | 21: oL (150%,1 minute, motor drive overloaded) 22: Motor overloaded (EoL1) 23: Reserved 24: Motor PTC overheat (oH3) 25: Reserved 26: over-torque 1 (ot1) 27: over-torque 2 (ot2) 28: Reserved 29: Reserved 30: Memory write-in error (cF1) 31: Memory read-out error (cF2) 32: Isum current detection error (cd0) 33: U-phase current detection error (cd1) 34: V-phase current detection error (cd2) 35: W-phase current detection error (cd3) 36: CC current clamp hardware error (Hd0) 37: OC(overcurrent) hardware error (Hd1) 38: ov (overvoltage hardware error (Hd2) 39: GFF(ground fault)hardware error (Hd3) 40: Auto tuning error on motor's parameters (AUE) 41: Reserved 42: PG feedback error (PGF1) 43: PG feedback loss (PGF2) 44: PG feedback stall (PGF3) 45: PG slip error (PGF4) 46: Reserved 47: Reserved 48: Reserved 49: External fault input (EF) 50: Emergency stop by external terminals (EF1) 51: Reserved 52: Password error after three attempts (Pcod) 53: Reserved 54: Illegal communication command (cE01) | | | | | | | |

| | | | | | | | | | | |
|---|-------|-------------------------------------------------------------------------------------------------------------------------------------------------------------------------------------------------------------------------------------------------------------------------------------------------------------------------------------------------------------------------------------------------------------------------------------------------------------------------------------------------------------------------------------------------------------------------------------------------------------------------------------------------------------------------------------------------------------------------------------------------------------------------------------------------------------------------------------------------------------|--------------------------------------------------------------|--------------|-----------------------|-----------------------|-----------------------|-----------------------|-----------------------|-----------------------|
| | | 55: Illegal communication address (cE02) 56: Communication data length error (cE03) 57: Communication being written to a read-only address (cE04) 58: Modbus transmission time-out (cE10) 59: Keypad transmission time-out (cP10) 60: Brake chopper error (BF) 61-63: Reserved 64: Mechanical brake feedback error (MBF) 65: PGF5 hardware error 66: Magnetic contactor error (MCF) 67: Output phase loss (MPHL) 68: CAN Bus disconnected (CANF) 69 ~71: Reserved 72: Safety torque loss (STL1) 73: PGcd hardware error 74: PG absolute signal error (PGHL) 75: PG Z phase signal loss (PGAF) 76: Safety torque output stops (STO) 77: Safety torque loss 2 (STL2) 78: Safety torque loss 3 (STL3) *The definition of codes #69~#71 have been modified in v1.04. See Ch14 for more information. | | | | | | | | |
| ✓ | 06-22 | Fault Output Option 1 | 0~65535 (refer to bit table for fault code) | 0 | <input type="radio"/> | <input type="radio"/> | <input type="radio"/> | <input type="radio"/> | <input type="radio"/> | <input type="radio"/> |
| ✓ | 06-23 | Fault Output Option 2 | 0~65535 (refer to bit table for fault code) | 0 | <input type="radio"/> | <input type="radio"/> | <input type="radio"/> | <input type="radio"/> | <input type="radio"/> | <input type="radio"/> |
| ✓ | 06-24 | Fault Output Option 3 | 0~65535 (refer to bit table for fault code) | 0 | <input type="radio"/> | <input type="radio"/> | <input type="radio"/> | <input type="radio"/> | <input type="radio"/> | <input type="radio"/> |
| ✓ | 06-25 | Fault Output Option 4 | 0~65535 (refer to bit table for fault code) | 0 | <input type="radio"/> | <input type="radio"/> | <input type="radio"/> | <input type="radio"/> | <input type="radio"/> | <input type="radio"/> |
| ✓ | 06-26 | PTC (Positive Temperature Coefficient) Detection Selection | 0: Warn and keep operation 1: Fault and ramp to stop | 0 | <input type="radio"/> | <input type="radio"/> | <input type="radio"/> | <input type="radio"/> | <input type="radio"/> | <input type="radio"/> |
| ✓ | 06-27 | PTC Level | 0.0~100.0% | 50.0 | <input type="radio"/> | <input type="radio"/> | <input type="radio"/> | <input type="radio"/> | <input type="radio"/> | <input type="radio"/> |
| ✓ | 06-28 | Filter Time for PTC Detection | 0.00~10.00sec. | 0.20 | <input type="radio"/> | <input type="radio"/> | <input type="radio"/> | <input type="radio"/> | <input type="radio"/> | <input type="radio"/> |
| | 06-29 | Voltage of Emergency Power | 24.0~375.0Vdc 48.0~750.0Vdc | 24.0 48.0 | <input type="radio"/> | <input type="radio"/> | <input type="radio"/> | <input type="radio"/> | <input type="radio"/> | <input type="radio"/> |
| ✓ | 06-30 | Setting Method of Fault Output | 0: By settings of Pr.06-22~06-25 1: By the binary setting | 0 | <input type="radio"/> | <input type="radio"/> | <input type="radio"/> | <input type="radio"/> | <input type="radio"/> | <input type="radio"/> |
| | 06-31 | Phase Loss Detection of Drive Output at Start up (MPHL) | 0: Disable 1: Enable | 0 | <input type="radio"/> | <input type="radio"/> | <input type="radio"/> | <input type="radio"/> | <input type="radio"/> | <input type="radio"/> |
| | 06-32 | Accumulative Drive Power-on Time at the First Fault (min.) | 00~1439 | 00 | <input type="radio"/> | <input type="radio"/> | <input type="radio"/> | <input type="radio"/> | <input type="radio"/> | <input type="radio"/> |
| | 06-33 | Accumulative Drive Power-on Time at the First Fault (day) | 00-65535 | 00 | <input type="radio"/> | <input type="radio"/> | <input type="radio"/> | <input type="radio"/> | <input type="radio"/> | <input type="radio"/> |
| | 06-34 | Accumulative Drive Power-on Time at the Second Fault (min.) | 00~1439 | 00 | <input type="radio"/> | <input type="radio"/> | <input type="radio"/> | <input type="radio"/> | <input type="radio"/> | <input type="radio"/> |
| | 06-35 | Accumulative Drive Power-on Time at the Second Fault (day) | 00-65535 | 00 | <input type="radio"/> | <input type="radio"/> | <input type="radio"/> | <input type="radio"/> | <input type="radio"/> | <input type="radio"/> |
| | 06-36 | Accumulative Drive Power-on Time at the Third Fault (min.) | 00~1439 | 00 | <input type="radio"/> | <input type="radio"/> | <input type="radio"/> | <input type="radio"/> | <input type="radio"/> | <input type="radio"/> |
| | 06-37 | Accumulative Drive Power-on Time at the Third Fault (day) | 00-65535 | 00 | <input type="radio"/> | <input type="radio"/> | <input type="radio"/> | <input type="radio"/> | <input type="radio"/> | <input type="radio"/> |
| | 06-38 | Accumulative Drive Power-on Time at the Fourth Fault (min.) | 00~1439 | 00 | <input type="radio"/> | <input type="radio"/> | <input type="radio"/> | <input type="radio"/> | <input type="radio"/> | <input type="radio"/> |

| | | | | | | | | | | |
|---|-------|------------------------------------------------------------|-----------------------------------------------------------------------------------------------------------------------------------------------------------------------------------------------------------------------------------------------------------------------------------------------------------------------------------------------------------------------------------------------------------------------------------------------------------------------------------------------------------------------------------------------------------------------------------------------------------------------|-----------|---|---|---|---|---|---|
| | 06-39 | Accumulative Drive Power-on Time at the Fourth Fault (day) | 00-65535 | 00 | ○ | ○ | ○ | ○ | ○ | ○ |
| | 06-40 | Accumulative Drive Power-on Time at the Fifth Fault (min.) | 00~1439 | 00 | ○ | ○ | ○ | ○ | ○ | ○ |
| | 06-41 | Accumulative Drive Power-on Time at the Fifth Fault (day) | 00-65535 | 00 | ○ | ○ | ○ | ○ | ○ | ○ |
| | 06-42 | Accumulative Drive Power-on Time at the Sixth Fault (min.) | 00~1439 | 00 | ○ | ○ | ○ | ○ | ○ | ○ |
| | 06-43 | Accumulative Drive Power-on Time at the Sixth Fault (day) | 00-65535 | 00 | ○ | ○ | ○ | ○ | ○ | ○ |
| ↙ | 06-44 | Operation Speed of (EPS) Emergency Power Mode | 0.00~400.00Hz | Read Only | ○ | ○ | ○ | ○ | ○ | ○ |
| ↙ | 06-45 | Fault and Warning Handling Methods | Bit0 = 0: Display Lv fault and coast to stop Bit0 = 1: Display Lv warn and coast to stop Bit1 = 0: Fan lock, fault and coast to stop Bit1 = 1: Fan lock, warn and coast to stop Bit2 = 0: software GFF protection enabled Bit2 = 1: software GFF protection disabled | 0 | ○ | ○ | ○ | ○ | ○ | ○ |
| ↙ | 06-46 | Operation Direction for (EPS) Emergency Power ON | 0: Run by following the current command 1: Run by following the direction of power generating mode. 2: After determining the direction of power generating, the host computer sends the operating direction command. (When at STOP mode determine the direction of power generating mode (MO =32) but do not retain the direction of the power generating.) 3. After determining the direction of power generating, the host computer send the operating direction command. (When at STOP mode, determine the direction of power generating mode (MO =32) and retain the direction of the power generating.) | 0 | ○ | ○ | ○ | ○ | ○ | ○ |
| ↙ | 06-47 | Power Generation Direction Searching Time | 0.0 ~ 5.0 sec. | 1.0 | ○ | ○ | ○ | ○ | ○ | ○ |
| | 06-48 | Power Capacity of (EPS) Emergency Power | 0.0 ~ 100.0 kVA | 0.0 | ○ | ○ | ○ | ○ | ○ | ○ |
| | 06-49 | STO Latch Selection | 0: STO Latch 1: STO No Latch 2: STO Latch (Warn and record running commands when stop) 3: STO No Latch (Warn and record running commands when stop) | 0 | ○ | ○ | ○ | ○ | ○ | ○ |
| | 06-50 | Selection of MO's action when retrying after fault | 0: Output 1: No output | 0 | ○ | ○ | ○ | ○ | ○ | ○ |
| | 06-51 | Number of times of retrying after fault | 0~10 | 0 | ○ | ○ | ○ | ○ | ○ | ○ |

| | | | | | | | | | |
|-------|------------------------------------------------------------------------|------------------|-------|--------------------------|--------------------------|--------------------------|--------------------------|--------------------------|--------------------------|
| 06-52 | Time interval between retrying | 0.5~600.0 sec. | 10.0 | <input type="checkbox"/> | <input type="checkbox"/> | <input type="checkbox"/> | <input type="checkbox"/> | <input type="checkbox"/> | <input type="checkbox"/> |
| 06-53 | Frequency command when the most recent fault has occurred | 0.00~655.35Hz | 0.00 | <input type="checkbox"/> | <input type="checkbox"/> | <input type="checkbox"/> | <input type="checkbox"/> | <input type="checkbox"/> | <input type="checkbox"/> |
| 06-54 | Output frequency when the most recent fault has occurred | 0.00~655.35Hz | 0.00 | <input type="checkbox"/> | <input type="checkbox"/> | <input type="checkbox"/> | <input type="checkbox"/> | <input type="checkbox"/> | <input type="checkbox"/> |
| 06-55 | Output current when the most recent fault has occurred | 0.00~655.35Amps | 0.00 | <input type="checkbox"/> | <input type="checkbox"/> | <input type="checkbox"/> | <input type="checkbox"/> | <input type="checkbox"/> | <input type="checkbox"/> |
| 06-56 | Most recent fault on motor's frequency | 0.00~655.35Hz | 0.00 | <input type="checkbox"/> | <input type="checkbox"/> | <input type="checkbox"/> | <input type="checkbox"/> | <input type="checkbox"/> | <input type="checkbox"/> |
| 06-57 | Output voltage when the most recent fault has occurred | 0.00~6553.5V | 0.0 | <input type="checkbox"/> | <input type="checkbox"/> | <input type="checkbox"/> | <input type="checkbox"/> | <input type="checkbox"/> | <input type="checkbox"/> |
| 06-58 | DC bus voltage when the most recent fault has occurred | 0.00~6553.5V | 0.0 | <input type="checkbox"/> | <input type="checkbox"/> | <input type="checkbox"/> | <input type="checkbox"/> | <input type="checkbox"/> | <input type="checkbox"/> |
| 06-59 | Output power when the most recent fault has occurred | 0.00~6553.5KW | 0.0 | <input type="checkbox"/> | <input type="checkbox"/> | <input type="checkbox"/> | <input type="checkbox"/> | <input type="checkbox"/> | <input type="checkbox"/> |
| 06-60 | Output torque when the most recent fault has occurred | 0.00~655.35% | 0.00 | <input type="checkbox"/> | <input type="checkbox"/> | <input type="checkbox"/> | <input type="checkbox"/> | <input type="checkbox"/> | <input type="checkbox"/> |
| 06-61 | IGBT's temperature when the most recent fault has occurred | -3276.8~3276.7°C | 0.0 | <input type="checkbox"/> | <input type="checkbox"/> | <input type="checkbox"/> | <input type="checkbox"/> | <input type="checkbox"/> | <input type="checkbox"/> |
| 06-62 | Multi-input terminals' status when the most recent fault has occurred | 0000h~FFFFh | 0000h | <input type="checkbox"/> | <input type="checkbox"/> | <input type="checkbox"/> | <input type="checkbox"/> | <input type="checkbox"/> | <input type="checkbox"/> |
| 06-63 | Multi-output terminals' status when the most recent fault has occurred | 0000h~FFFFh | 0000h | <input type="checkbox"/> | <input type="checkbox"/> | <input type="checkbox"/> | <input type="checkbox"/> | <input type="checkbox"/> | <input type="checkbox"/> |
| 06-64 | Motor drive's status when the most recent fault has occurred | 0000h~FFFFh | 0000h | <input type="checkbox"/> | <input type="checkbox"/> | <input type="checkbox"/> | <input type="checkbox"/> | <input type="checkbox"/> | <input type="checkbox"/> |

07 Special Parameters

| Pr. | Explanation | Setting Range | Factory Setting | VF | VFP | SVC | FOCPG | TQCPG | FOCPM |
|---------|----------------------------------------|-----------------------------------------------------------------------------------------------------------------------------------------------------------------------------------------------------------------------------------------------------------------------------------------------------------|-----------------|--------------------------|--------------------------|--------------------------|--------------------------|--------------------------|--------------------------|
| | | | | <input type="checkbox"/> | <input type="checkbox"/> | <input type="checkbox"/> | <input type="checkbox"/> | <input type="checkbox"/> | <input type="checkbox"/> |
| ✓ 07-00 | Brake Chopper Level | 230V series: 350.0~450.0Vdc 460V series: 700.0~900.0Vdc | 380.0 760.0 | <input type="checkbox"/> | <input type="checkbox"/> | <input type="checkbox"/> | <input type="checkbox"/> | <input type="checkbox"/> | <input type="checkbox"/> |
| 07-01 | Reserved | | | | | | | | |
| ✓ 07-02 | DC Brake Current Level during start-up | 0~100% (rated current of the motor drive) | 0 | <input type="checkbox"/> | <input type="checkbox"/> | <input type="checkbox"/> | | | |
| ✓ 07-03 | DC Brake Activation Time | 0.0~60.0sec. | 0.7 | <input type="checkbox"/> | <input type="checkbox"/> | <input type="checkbox"/> | <input type="checkbox"/> | | <input type="checkbox"/> |
| ✓ 07-04 | DC Brake Stopping Time | 0.0~60.0sec. | 0.7 | <input type="checkbox"/> | <input type="checkbox"/> | <input type="checkbox"/> | <input type="checkbox"/> | | <input type="checkbox"/> |
| ✓ 07-05 | Start Point for DC Brake | 0.00~400.00Hz | 0.00 | <input type="checkbox"/> | <input type="checkbox"/> | <input type="checkbox"/> | <input type="checkbox"/> | | |
| ✓ 07-06 | DC Brake Proportional Gain | 1~500 | 50 | <input type="checkbox"/> | <input type="checkbox"/> | <input type="checkbox"/> | | | |
| ✓ 07-07 | Dwell Time at Accel. | 0.00~600.00sec. | 0.00 | <input type="checkbox"/> | <input type="checkbox"/> | <input type="checkbox"/> | <input type="checkbox"/> | | <input type="checkbox"/> |
| ✓ 07-08 | Dwell Frequency at Accel. | 0.00~400.00Hz | 0.00 | <input type="checkbox"/> | <input type="checkbox"/> | <input type="checkbox"/> | <input type="checkbox"/> | | <input type="checkbox"/> |
| ✓ 07-09 | Dwell Time at Decel. | 0.00~600.00sec. | 0.00 | <input type="checkbox"/> | <input type="checkbox"/> | <input type="checkbox"/> | <input type="checkbox"/> | | <input type="checkbox"/> |
| ✓ 07-10 | Dwell Frequency at Decel. | 0.00~400.00Hz | 0.00 | <input type="checkbox"/> | <input type="checkbox"/> | <input type="checkbox"/> | <input type="checkbox"/> | | <input type="checkbox"/> |
| ✓ 07-11 | Cooling Fan Control | 0: Cooling fan always ON 1: One minute after AC motor drive stops, cooling fan will be OFF 2: AC motor drive runs and cooling fan ON, AC motor drive stops and cooling fan OFF 3: Cooling fan ON to run when preliminary heat sink temperature attained 4: Cooling always OFF | 2 | <input type="checkbox"/> | <input type="checkbox"/> | <input type="checkbox"/> | <input type="checkbox"/> | <input type="checkbox"/> | <input type="checkbox"/> |
| ✓ 07-12 | Torque command | -150.0~150.0% (Pr07-14 setting =100%) | 0.0 | | | | | <input type="checkbox"/> | |
| ✓ 07-13 | Source of Torque Command | 0: Digital keypad (KPC-CC01) 1: RS485 serial communication (RJ-11) 2: Analog signal (Pr.03-00) | 2 | | | | | <input type="checkbox"/> | |
| ✓ 07-14 | Maximum Torque Command | 0~300% (rated torque of the motor drive) | 100 | <input type="checkbox"/> | <input type="checkbox"/> | <input type="checkbox"/> | <input type="checkbox"/> | <input type="checkbox"/> | <input type="checkbox"/> |
| ✓ 07-15 | Filter Time of Torque Command | 0.000~1.000sec. | 0.000 | | | | | <input type="checkbox"/> | |
| 07-16 | Speed Limit Selection | 0: By Pr.07-17 and Pr.07-18 1: Frequency command source (Pr.00-14) | 0 | | | | | <input type="checkbox"/> | |
| ✓ 07-17 | Torque Mode +Speed Limit | 0~120% | 10 | | | | | <input type="checkbox"/> | |
| ✓ 07-18 | Torque Mode-Speed Limit | 0~120% | 10 | | | | | <input type="checkbox"/> | |
| ✓ 07-19 | Source of Torque Offset | 0: Disable 1: Analog input (Pr.03-00) 2: Torque offset setting (Pr.07-20) 3: Control by external terminal (by Pr.07-21 to Pr.07-23) | 0 | | | <input type="checkbox"/> | <input type="checkbox"/> | <input type="checkbox"/> | <input type="checkbox"/> |
| ✓ 07-20 | Torque Offset Setting | 0.0~100.0% (rated torque of the motor drive) | 0.0 | | | <input type="checkbox"/> | <input type="checkbox"/> | <input type="checkbox"/> | <input type="checkbox"/> |

| | | | | | | | | | | |
|---|-------|---------------------------------------------|--------------------------------------------------------------------------------------------------------------------------------------------------------|-------|-----------------------|-----------------------|-----------------------|-----------------------|-----------------------|-----------------------|
| ↗ | 07-21 | High Torque Offset | 0.0~100.0% (rated torque of the motor drive) | 30.0 | | | <input type="radio"/> | <input type="radio"/> | <input type="radio"/> | <input type="radio"/> |
| ↗ | 07-22 | Middle Torque Offset | 0.0~100.0% (rated torque of the motor drive) | 20.0 | | | <input type="radio"/> | <input type="radio"/> | <input type="radio"/> | <input type="radio"/> |
| ↗ | 07-23 | Low Torque Offset | 0.0~100.0% (rated torque of the motor drive) | 10.0 | | | <input type="radio"/> | <input type="radio"/> | <input type="radio"/> | <input type="radio"/> |
| ↗ | 07-24 | Forward Motor Torque Limit | 0~300% (rated torque of the motor drive) | 200 | | | <input type="radio"/> | <input type="radio"/> | <input type="radio"/> | |
| ↗ | 07-25 | Forward Regenerative Torque Limit | 0~300% (rated torque of the motor drive) | 200 | | | <input type="radio"/> | <input type="radio"/> | <input type="radio"/> | |
| ↗ | 07-26 | Reverse Motor Torque Limit | 0~300% (rated torque of the motor drive) | 200 | | | <input type="radio"/> | <input type="radio"/> | <input type="radio"/> | |
| ↗ | 07-27 | Reverse Regenerative Torque Limit | 0~300% (rated torque of the motor drive) | 200 | | | <input type="radio"/> | <input type="radio"/> | <input type="radio"/> | |
| ↗ | 07-28 | Emergency Stop (EF) & Forced Stop Selection | 0: Coast to stop 1: By deceleration Time 1 2: By deceleration Time 2 3: By deceleration Time 3 4: By deceleration Time 4 5: By Pr.01-31 | 0 | <input type="radio"/> | <input type="radio"/> | <input type="radio"/> | <input type="radio"/> | <input type="radio"/> | <input type="radio"/> |
| ↗ | 07-29 | Time for Decreasing Torque at Stop | 0.000~1.000sec. | 0.000 | | | <input type="radio"/> | <input type="radio"/> | <input type="radio"/> | |
| ↗ | 07-30 | DC Brake Current Level Stop | 0~100% (rated current of the motor drive) | 0 | <input type="radio"/> | <input type="radio"/> | <input type="radio"/> | | | |

08 PM Parameters

| Pr. | Explanation | Setting Range | Factory Setting | VF | VFP | SVC | FOCPG | TQCPG | FOCPM |
|-------|-------------------------------------------|-----------------------------------------------------------------------------------------------------------------------------------------------------------------------------------------------------------------------|-----------------|----|-----|-----|-------|-------|-----------------------|
| 08-00 | Motor Auto Tuning | 0: No function 1: Only for the unloaded motor, auto measure the angle between magnetic pole and PG origin (08-09) 2: For PM parameters 3: Auto measure the angle between magnetic pole and PG origin (08-09) | 0 | | | | | | <input type="radio"/> |
| 08-01 | Full-load Current of Motor | (40~120%) *00-01 Amps | ### | | | | | | <input type="radio"/> |
| 08-02 | Rated power of Motor | 0.00~655.35kW | ### | | | | | | <input type="radio"/> |
| 08-03 | Rated speed of Motor (rpm) | 0~65535 | 1710 | | | | | | <input type="radio"/> |
| 08-04 | Number of Motor Poles | 2~96 | 4 | | | | | | <input type="radio"/> |
| 08-05 | Rs of Motor | 0.000~65.535Ω | 0.000 | | | | | | <input type="radio"/> |
| 08-06 | Ld of Motor | 0.0~6553.5mH | 0.0 | | | | | | <input type="radio"/> |
| 08-07 | Lq of Motor | 0.0~6553.5mH | 0.0 | | | | | | <input type="radio"/> |
| 08-08 | Back Electromotive Force | 0.0~6553.5Vrms | 0.0 | | | | | | <input type="radio"/> |
| 08-09 | Angle between Magnetic Pole and PG Origin | 0.0~360.0° | 360.0 | | | | | | <input type="radio"/> |
| 08-10 | Magnetic Pole Re-orientation | 0: Disable 1: Enable | 0 | | | | | | <input type="radio"/> |

09 Communication Parameters

| Pr. | Explanation | Setting Range | Factory Setting | VF | VFPG | SVC | FOCPG | TQCPG | FOCPM |
|-----------------|------------------------------|------------------------------------------------------------------------------------------------------------------------------------------------------------------------------------------------------------------------------------------------------------------------------------------------------------------------------|-----------------|-----------------------|-----------------------|-----------------------|-----------------------|-----------------------|-----------------------|
| | | | | | | | | | |
| ✓ 09-00 | Communication Address | 1~254 | 1 | | | | | | |
| ✓ 09-01 | Transmission Speed | 4.8~115.2Kbps | 19.2 | <input type="radio"/> | <input type="radio"/> | <input type="radio"/> | <input type="radio"/> | <input type="radio"/> | <input type="radio"/> |
| ✓ 09-02 | Transmission Fault Treatment | 0: Warn and keep operation 1: Warn and ramp to stop 2: Reserved 3: No action and no display | 3 | <input type="radio"/> | <input type="radio"/> | <input type="radio"/> | <input type="radio"/> | <input type="radio"/> | <input type="radio"/> |
| ✓ 09-03 | Time-out Detection | 0.0~100.0sec. | 0.0 | <input type="radio"/> | <input type="radio"/> | <input type="radio"/> | <input type="radio"/> | <input type="radio"/> | <input type="radio"/> |
| ✓ 09-04 | Communication Protocol | 0: 7N1 (ASCII) 1: 7N2 (ASCII) 2: 7E1 (ASCII) 3: 7O1 (ASCII) 4: 7E2 (ASCII) 5: 7O2 (ASCII) 6: 8N1 (ASCII) 7: 8N2 (ASCII) 8: 8E1 (ASCII) 9: 8O1 (ASCII) 10: 8E2 (ASCII) 11: 8O2 (ASCII) 12: 8N1 (RTU) 13: 8N2 (RTU) 14: 8E1 (RTU) 15: 8O1 (RTU) 16: 8E2 (RTU) 17: 8O2 (RTU) | 13 | <input type="radio"/> | <input type="radio"/> | <input type="radio"/> | <input type="radio"/> | <input type="radio"/> | <input type="radio"/> |
| ✓ 09-05 | Response Delay Time | 0.0~200.0ms | 2.0 | <input type="radio"/> | <input type="radio"/> | <input type="radio"/> | <input type="radio"/> | <input type="radio"/> | <input type="radio"/> |
| 09-06 ~09-13 | Direct docking mode only ◆ | | | | | | | | |

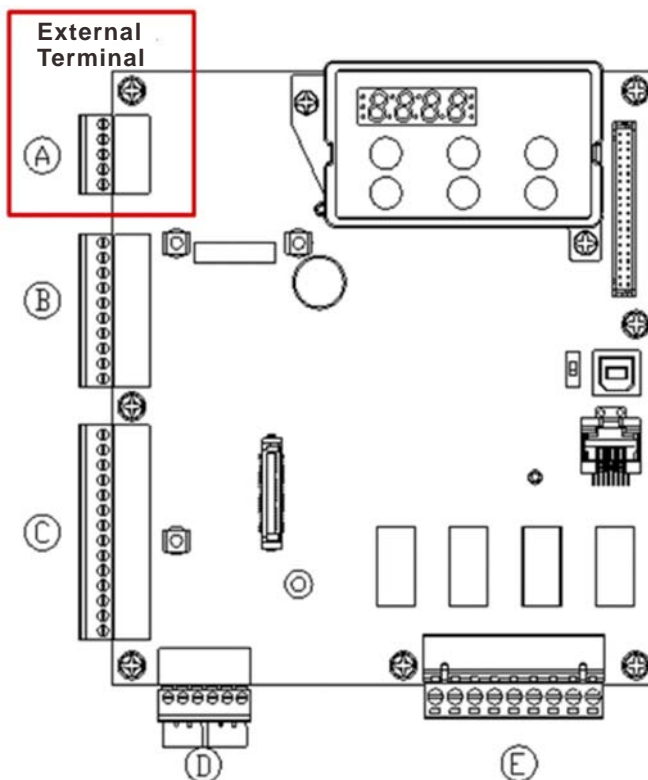

10 Speed Feedback Control Parameters

| Pr. | Explanation | Setting Range | Factory Setting | VF | VFP | SVC | FOCPG | TQCPG | FOCPM |
|---------|-------------------------------------------------------|---------------------------------------------------------------------------------------------------------------------------------------------------------------------------------------------------------------------------------------------------------------------------------------------------------------------------------------------------------------------------------------------------------------------------------------------------------------------------------------------------|-----------------|----|-----------------------|-----------------------|-----------------------|-----------------------|-----------------------|
| | | | | | | | | | |
| 10-00 | Selection of Encoder | 0: Disable 1: ABZ 2: ABZ+Hall 3: SIN/COS + Sinusoidal 4: SIN/COS + Endat 5: SIN/COS 6: SIN/COS + Hiperface | 0 | | <input type="radio"/> | | <input type="radio"/> | <input type="radio"/> | <input type="radio"/> |
| 10-01 | Encoder Pulse | 1~25000 | 2048 | | <input type="radio"/> | | <input type="radio"/> | <input type="radio"/> | <input type="radio"/> |
| 10-02 | Encoder Input Type Setting | 0: Disable 1: Phase A leads in a forward run command and phase B leads in a reverse run command 2: Phase B leads in a forward run command and phase A leads in a reverse run command 3: Phase A is a pulse input and phase B is a direction input. (low input=reverse direction, high input=forward direction) 4: Phase A is a pulse input and phase B is a direction input. (low input=forward direction, high input=reverse direction) 5: Single-phase input | 0 | | <input type="radio"/> | | <input type="radio"/> | <input type="radio"/> | <input type="radio"/> |
| ✓ 10-03 | Encoder Feedback Fault Treatment (PGF1, PGF2) | 0: Warn and keep operation 1: Fault and ramp to stop 2: Fault and stop operation | 2 | | <input type="radio"/> | | <input type="radio"/> | <input type="radio"/> | <input type="radio"/> |
| ✓ 10-04 | Detection Time for Encoder Feedback Fault | 0.0~10.0sec. | 1.0 | | <input type="radio"/> | | <input type="radio"/> | <input type="radio"/> | <input type="radio"/> |
| ✓ 10-05 | Encoder Stall Level (PGF3) | 0~120% (0: Disable) | 115 | | <input type="radio"/> | <input type="radio"/> | <input type="radio"/> | | <input type="radio"/> |
| ✓ 10-06 | Encoder Stall Detection Time | 0.0~2.0sec. | 0.1 | | <input type="radio"/> | <input type="radio"/> | <input type="radio"/> | | <input type="radio"/> |
| ✓ 10-07 | Encoder Slip Range (PGF4) | 0~50% (0: Disable) | 50 | | <input type="radio"/> | <input type="radio"/> | <input type="radio"/> | | <input type="radio"/> |
| ✓ 10-08 | Encoder Slip Detection Time | 0.0~10.0sec. | 0.5 | | <input type="radio"/> | <input type="radio"/> | <input type="radio"/> | | <input type="radio"/> |
| ✓ 10-09 | Encoder Stall and Slip Error Treatment | 0: Warn and keep operation 1: Fault and ramp to stop 2: Fault and coast to stop | 2 | | <input type="radio"/> | <input type="radio"/> | <input type="radio"/> | | <input type="radio"/> |
| 10-10 | Mode Selection for UVW Input | 0: Z signal is at the falling edge of U-phase 1: Z signal is at the rising edge of U-phase | 0 | | <input type="radio"/> | | <input type="radio"/> | <input type="radio"/> | <input type="radio"/> |
| ✓ 10-11 | ASR (Auto Speed Regulation) Control (P) of Zero Speed | 0.0~1000.0% | 100.0 | | <input type="radio"/> | <input type="radio"/> | <input type="radio"/> | <input type="radio"/> | <input type="radio"/> |
| ✓ 10-12 | ASR (Auto Speed Regulation) Control (I) of Zero Speed | 0.000~10.000sec. | 0.100 | | <input type="radio"/> | <input type="radio"/> | <input type="radio"/> | <input type="radio"/> | <input type="radio"/> |
| ✓ 10-13 | ASR (Auto Speed Regulation) Control (P) 1 | 0.0~1000.0% | 100.0 | | <input type="radio"/> | <input type="radio"/> | <input type="radio"/> | <input type="radio"/> | <input type="radio"/> |
| ✓ 10-14 | ASR (Auto Speed Regulation) Control (I) 1 | 0.000~10.000sec. | 0.100 | | <input type="radio"/> | <input type="radio"/> | <input type="radio"/> | <input type="radio"/> | <input type="radio"/> |
| ✓ 10-15 | ASR (Auto Speed Regulation) Control (P) 2 | 0.0~1000.0% | 100.0 | | <input type="radio"/> | <input type="radio"/> | <input type="radio"/> | <input type="radio"/> | <input type="radio"/> |

| | | | | | | | | | | |
|---|-------|----------------------------------------------|----------------------------------------------------------------------------------------------------------------|-------|-----------------------|-----------------------|-----------------------|-----------------------|-----------------------|-----------------------|
| ✓ | 10-16 | ASR (Auto Speed Regulation) Control (I) 2 | 0.000~10.000sec. | 0.100 | <input type="radio"/> | <input type="radio"/> | <input type="radio"/> | <input type="radio"/> | <input type="radio"/> | <input type="radio"/> |
| ✓ | 10-17 | ASR 1/ ASR2 Switch Frequency | 0.00~400.00Hz (0: Disable) | 7.00 | <input type="radio"/> | <input type="radio"/> | <input type="radio"/> | <input type="radio"/> | <input type="radio"/> | <input type="radio"/> |
| ✓ | 10-18 | ASR Primary Low Pass Filter Gain | 0.000~0.350sec. | 0.008 | <input type="radio"/> | <input type="radio"/> | <input type="radio"/> | <input type="radio"/> | <input type="radio"/> | <input type="radio"/> |
| ✓ | 10-19 | Zero Speed Gain (P) | 0~655.00% | 80.00 | | | | | | <input type="radio"/> |
| ✓ | 10-20 | Zero Speed/ ASR1 Width Adjustment | 0.00~400.00Hz | 5.00 | | <input type="radio"/> | | <input type="radio"/> | | <input type="radio"/> |
| ✓ | 10-21 | ASR1/ASR2 Width Adjustment | 0.00~400.00Hz | 5.00 | | <input type="radio"/> | | <input type="radio"/> | | <input type="radio"/> |
| ✓ | 10-22 | Zero speed Position Holding Time | 0.000~65.535s | 0.250 | | | | | | <input type="radio"/> |
| ✓ | 10-23 | Filter Time at Zero Speed | 0.000~65.535s | 0.004 | | | | | | <input type="radio"/> |
| ✓ | 10-24 | Time for Executing Zero Speed | 0: after the brake release set in Pr.02-29 1: after the brake signal input (Pr.02-01~02-08 is set to 42) | 0 | | | | | | <input type="radio"/> |
| ✓ | 10-25 | Elevator Leveling (Zero Speed Gain P) | 0.0~1000.0% | 100.0 | <input type="radio"/> | <input type="radio"/> | <input type="radio"/> | <input type="radio"/> | <input type="radio"/> | <input type="radio"/> |
| ✓ | 10-26 | Elevator Leveling (Zero Speed Integral I) | 0.000~10.000sec. | 0.100 | <input type="radio"/> | <input type="radio"/> | <input type="radio"/> | <input type="radio"/> | <input type="radio"/> | <input type="radio"/> |
| ✓ | 10-27 | Elevator Starts (Zero Speed Gain P) | 0.0~1000.0% | 100.0 | <input type="radio"/> | <input type="radio"/> | <input type="radio"/> | <input type="radio"/> | <input type="radio"/> | <input type="radio"/> |
| ✓ | 10-28 | Elevator Starts (Zero Speed Integral I) | 0.000~10.000sec. | 0.100 | <input type="radio"/> | <input type="radio"/> | <input type="radio"/> | <input type="radio"/> | <input type="radio"/> | <input type="radio"/> |
| ✓ | 10-29 | Setting of PG card frequency division output | 0~31 | 0 | | <input type="radio"/> | | <input type="radio"/> | <input type="radio"/> | <input type="radio"/> |
| ✓ | 10-30 | Type of PG card frequency division output | 0000h~0008h | 0000h | | <input type="radio"/> | | <input type="radio"/> | <input type="radio"/> | <input type="radio"/> |
| | 10-31 | PG card C+/C- Selection | 0000h~0001h | 0000h | | | | | | |

11 Advanced Parameters

| Pr. | Explanation | Setting Range | Factory Setting | VF | VFG | SVC | FOCPG | TQCPG | FOCPM |
|-------|----------------|---------------------------------------------------------------------------------------------------------------------------------------------------------------------------------------------------------------------------------------------------------------------------------------------------------------------------------------------------------------------------------------------------------------------------------------------------------------------------------------------------------------------------------------------------------|---------------------------|-------|-----------------------|-----------------------|-----------------------|-----------------------|-----------------------|
| | | | | | | | | | |
| 11-00 | System Control | Bit 0=0: no function Bit 0=1: ASR Auto tuning, PDFF enable Bit 7=0: no function Bit 7=1: When position control is enabled, it doesn't need to set Pr.07-02 (DC Brake Current Level) Bit 9=0: Rolling PG Origin auto-tuning with load (support by PGHSD-1) Bit 9=1: Static PG Origin auto-tuning with load by enabling PGHSD-1 Bit 15=0: when power is applied, it will detect the position of magnetic pole again Bit 15=1: when power is applied, it will start from the magnetic pole position of previous power failure | 0 | | | | <input type="radio"/> | | <input type="radio"/> |
| ✓ | 11-01 | Elevator Speed | 0.10~4.00 m/s | 1.00 | | | <input type="radio"/> | | <input type="radio"/> |
| ✓ | 11-02 | Sheave Diameter | 100~2000mm | 400 | | | <input type="radio"/> | | <input type="radio"/> |
| ✓ | 11-03 | Mechanical Gear Ratio | 1~100 | 1 | | | <input type="radio"/> | | <input type="radio"/> |
| ✓ | 11-04 | Suspension Ratio | 0= 1:1 1= 2:1 | 1 | | | <input type="radio"/> | | <input type="radio"/> |
| ✓ | 11-05 | Inertial Ratio | 1~300% | 40 | | | <input type="radio"/> | | <input type="radio"/> |
| ✓ | 11-06 | Zero-speed Bandwidth | 1~40Hz | 10 | | | <input type="radio"/> | | <input type="radio"/> |
| ✓ | 11-07 | Low-speed Bandwidth | 1~40Hz | 10 | | | <input type="radio"/> | | <input type="radio"/> |
| ✓ | 11-08 | High-speed Bandwidth | 1~40Hz | 10 | | | <input type="radio"/> | | <input type="radio"/> |
| ✓ | 11-09 | PDFF Gain Value | 0~200% | 30 | | | <input type="radio"/> | | <input type="radio"/> |
| ✓ | 11-10 | Gain for Speed Feed Forward | 0~500 | 0 | | | <input type="radio"/> | | <input type="radio"/> |
| ✓ | 11-11 | Notch Filter Depth | 0~20db | 0 | | | <input type="radio"/> | | <input type="radio"/> |
| ✓ | 11-12 | Notch Filter Frequency | 0.00~200.00Hz | 0.00 | | | <input type="radio"/> | | <input type="radio"/> |
| ✓ | 11-13 | Low-pass Filter Time of Keypad Display | 0.001~65.535s | 0.500 | <input type="radio"/> | <input type="radio"/> | <input type="radio"/> | <input type="radio"/> | <input type="radio"/> |
| ✓ | 11-14 | Motor Current at Accel. | 50~200% | 150 | | | | | <input type="radio"/> |
| ✓ | 11-15 | Elevator Acceleration | 0.20~2.00m/s ² | 0.75 | | | | | <input type="radio"/> |
| | 11-16 | Reserved | 0000h~FFFFh | 0 | <input type="radio"/> | <input type="radio"/> | <input type="radio"/> | <input type="radio"/> | <input type="radio"/> |
| | 11-17 | Reserved | Read Only | ### | <input type="radio"/> | <input type="radio"/> | <input type="radio"/> | <input type="radio"/> | <input type="radio"/> |
| | 11-18 | Reserved | 0000h~FFFFh | ### | <input type="radio"/> | <input type="radio"/> | <input type="radio"/> | <input type="radio"/> | <input type="radio"/> |
| ✓ | 11-19 | Zero-speed Holding Speed | 1~40Hz | 10 | | | <input type="radio"/> | | <input type="radio"/> |

12 User Defined Parameters

User-defined Parameters with range from Group 00 to Group 11

| Pr. | Explanation (Default Function) | Address | Factory setting | VF | VFP | SVC | FOCPG | TQCPG | FOCPM |
|---------|---------------------------------------------------------|---------|--------------------|-----------------------|-----------------------|-----------------------|-----------------------|-----------------------|-----------------------|
| | | | | | | | | | |
| ✓ 12-00 | Present Fault Record | 0616 | Read Only | <input type="radio"/> | <input type="radio"/> | <input type="radio"/> | <input type="radio"/> | <input type="radio"/> | <input type="radio"/> |
| ✓ 12-01 | Present Fault Time of Motor Operation (min.) | 0632 | Read Only | <input type="radio"/> | <input type="radio"/> | <input type="radio"/> | <input type="radio"/> | <input type="radio"/> | <input type="radio"/> |
| ✓ 12-02 | Present Fault Time of Motor Operation (day) | 0633 | Read Only | <input type="radio"/> | <input type="radio"/> | <input type="radio"/> | <input type="radio"/> | <input type="radio"/> | <input type="radio"/> |
| ✓ 12-03 | Frequency Command at Present Fault | 0653 | Read Only | <input type="radio"/> | <input type="radio"/> | <input type="radio"/> | <input type="radio"/> | <input type="radio"/> | <input type="radio"/> |
| ✓ 12-04 | Output Frequency at Present Fault | 0654 | Read Only | <input type="radio"/> | <input type="radio"/> | <input type="radio"/> | <input type="radio"/> | <input type="radio"/> | <input type="radio"/> |
| ✓ 12-05 | Output Current at Present Fault | 0655 | Read Only | <input type="radio"/> | <input type="radio"/> | <input type="radio"/> | <input type="radio"/> | <input type="radio"/> | <input type="radio"/> |
| ✓ 12-06 | Motor Frequency at Present Fault | 0656 | Read Only | <input type="radio"/> | <input type="radio"/> | <input type="radio"/> | <input type="radio"/> | <input type="radio"/> | <input type="radio"/> |
| ✓ 12-07 | Output Voltage at Present Fault | 0657 | Read Only | <input type="radio"/> | <input type="radio"/> | <input type="radio"/> | <input type="radio"/> | <input type="radio"/> | <input type="radio"/> |
| ✓ 12-08 | DC-Bus Voltage at Present Fault | 0658 | Read Only | <input type="radio"/> | <input type="radio"/> | <input type="radio"/> | <input type="radio"/> | <input type="radio"/> | <input type="radio"/> |
| ✓ 12-09 | Output Power at Present Fault | 0659 | Read Only | <input type="radio"/> | <input type="radio"/> | <input type="radio"/> | <input type="radio"/> | <input type="radio"/> | <input type="radio"/> |
| ✓ 12-10 | Output Torque at Present Fault | 0660 | Read Only | <input type="radio"/> | <input type="radio"/> | <input type="radio"/> | <input type="radio"/> | <input type="radio"/> | <input type="radio"/> |
| ✓ 12-11 | IGBT Temperature of Power Module at Present Fault | 0661 | Read Only | <input type="radio"/> | <input type="radio"/> | <input type="radio"/> | <input type="radio"/> | <input type="radio"/> | <input type="radio"/> |
| ✓ 12-12 | Multi-function Terminal Input Status at Present Fault | 0662 | Read Only | <input type="radio"/> | <input type="radio"/> | <input type="radio"/> | <input type="radio"/> | <input type="radio"/> | <input type="radio"/> |
| ✓ 12-13 | Multi-function Terminal Output Status at Present Fault | 0663 | Read Only | <input type="radio"/> | <input type="radio"/> | <input type="radio"/> | <input type="radio"/> | <input type="radio"/> | <input type="radio"/> |
| ✓ 12-14 | Drive Status at Present Fault | 0664 | Read Only | <input type="radio"/> | <input type="radio"/> | <input type="radio"/> | <input type="radio"/> | <input type="radio"/> | <input type="radio"/> |
| ✓ 12-15 | Second Most Recent Fault Record | 0617 | Read Only | <input type="radio"/> | <input type="radio"/> | <input type="radio"/> | <input type="radio"/> | <input type="radio"/> | <input type="radio"/> |
| ✓ 12-16 | Second Most Recent Fault Time of Motor Operation (min.) | 0634 | Read Only | <input type="radio"/> | <input type="radio"/> | <input type="radio"/> | <input type="radio"/> | <input type="radio"/> | <input type="radio"/> |
| ✓ 12-17 | Second Most Recent Fault Time of Motor Operation (day) | 0635 | Read Only | <input type="radio"/> | <input type="radio"/> | <input type="radio"/> | <input type="radio"/> | <input type="radio"/> | <input type="radio"/> |
| ✓ 12-18 | Third Most Recent Fault Record | 0618 | Read Only | <input type="radio"/> | <input type="radio"/> | <input type="radio"/> | <input type="radio"/> | <input type="radio"/> | <input type="radio"/> |
| ✓ 12-19 | Third Most Recent Fault Time of Motor Operation (min.) | 0636 | Read Only | <input type="radio"/> | <input type="radio"/> | <input type="radio"/> | <input type="radio"/> | <input type="radio"/> | <input type="radio"/> |
| ✓ 12-20 | Third Most Recent Fault Time of Motor Operation (day) | 0637 | Read Only | <input type="radio"/> | <input type="radio"/> | <input type="radio"/> | <input type="radio"/> | <input type="radio"/> | <input type="radio"/> |
| ✓ 12-21 | Fourth Most Recent Fault Record | 0619 | Read Only | <input type="radio"/> | <input type="radio"/> | <input type="radio"/> | <input type="radio"/> | <input type="radio"/> | <input type="radio"/> |
| ✓ 12-22 | Fourth Most Recent Fault Time of Motor Operation (min.) | 0638 | Read Only | <input type="radio"/> | <input type="radio"/> | <input type="radio"/> | <input type="radio"/> | <input type="radio"/> | <input type="radio"/> |
| ✓ 12-23 | Fourth Most Recent Fault Time of Motor Operation (day) | 0639 | Read Only | <input type="radio"/> | <input type="radio"/> | <input type="radio"/> | <input type="radio"/> | <input type="radio"/> | <input type="radio"/> |
| ✓ 12-24 | Fifth Most Recent Fault Record | 0620 | Read Only | <input type="radio"/> | <input type="radio"/> | <input type="radio"/> | <input type="radio"/> | <input type="radio"/> | <input type="radio"/> |
| ✓ 12-25 | Fifth Most Recent Fault Time of Motor Operation (min.) | 0640 | Read Only | <input type="radio"/> | <input type="radio"/> | <input type="radio"/> | <input type="radio"/> | <input type="radio"/> | <input type="radio"/> |
| ✓ 12-26 | Fifth Most Recent Fault Time of Motor Operation (day) | 0641 | Read Only | <input type="radio"/> | <input type="radio"/> | <input type="radio"/> | <input type="radio"/> | <input type="radio"/> | <input type="radio"/> |
| ✓ 12-27 | Sixth Most Recent Fault Record | 0621 | Read Only | <input type="radio"/> | <input type="radio"/> | <input type="radio"/> | <input type="radio"/> | <input type="radio"/> | <input type="radio"/> |
| ✓ 12-28 | Sixth Most Recent Fault Time of Motor Operation (min.) | 0642 | Read Only | <input type="radio"/> | <input type="radio"/> | <input type="radio"/> | <input type="radio"/> | <input type="radio"/> | <input type="radio"/> |
| ✓ 12-29 | Sixth Most Recent Fault Time of Motor Operation (day) | 0643 | Read Only | <input type="radio"/> | <input type="radio"/> | <input type="radio"/> | <input type="radio"/> | <input type="radio"/> | <input type="radio"/> |
| ✓ 12-30 | No factory setting | | | | | | | | |
| ✓ 12-31 | No factory setting | | | | | | | | |

13 View User Defined Parameters

| Pr. | Explanation | Setting Range | Factory Setting | VF | VFPG | SVC | FOCPG | TQCPG | FOCPM |
|---------------------|------------------------------|------------------|-----------------|----|------|-----|-------|-------|-------|
| 13-00 ~ 13-31 | View User Defined Parameters | Pr00-00~ Pr11-19 | - | ○ | ○ | ○ | ○ | ○ | ○ |

12 Descriptions of Parameter Settings



↗: The parameter can be set during operation

00 Drive Parameters

00-00 Identity Code of the AC Motor Drive

Control Mode **VF VFPG SVC FOC PG TQCPG FOC PM** Factory setting: ##
Settings Read Only

00-01 Rated Current Display of the AC Motor Drive

Control Mode **VF VFPG SVC FOC PG TQCPG FOC PM** Factory setting: ##
Settings Read Only

Pr. 00-00 displays the identity code of the AC motor drive. The capacity, rated current, rated voltage and the max. carrier frequency relate to the identity code. Users can use the following table to check how the rated current, rated voltage and max. carrier frequency of the AC motor drive corresponds to the identity code.

Pr.00-01 displays the rated current of the AC motor drive. By reading this parameter the user can check if the AC motor drive is correct.

| 230V series | | | | | | | | | | | |
|-----------------------------------------------|---------|------|-----|-------|-----|----|------|------|--------|-----|-----|
| Power (KW) | 2.2* | 3.7* | 4.0 | 5.5 | 7.5 | 11 | 15 | 18.5 | 22 | 30 | 37 |
| Horsepower (HP) | 3 | 5 | 5 | 7.5 | 10 | 15 | 20 | 25 | 30 | 40 | 50 |
| ID Code of the Motor Drive (Pr00-00) | 108 | 110 | 10 | 12 | 14 | 16 | 18 | 20 | 22 | 24 | 26 |
| Rated Output Current for General Purposes (A) | 12.0 | 17.0 | 20 | 24 | 30 | 45 | 58 | 77 | 87 | 132 | 161 |
| Range of the Carrier Frequency | 2~15kHz | | | | | | | | 2~9kHz | | |
| Rated Max. Output Carrier Frequency | 8kHz | | | 10kHz | | | 8kHz | | 6kHz | | |

*VFD022ED21S and VFD037ED21S are single phase models.

| 460V series | | | | | | | | | | | | |
|-----------------------------------------------|----------|-------|-----|----|------|------|---------|------|----|---------|-----|-----|
| Power (KW) | 4.0 | 5.5 | 7.5 | 11 | 15 | 18.5 | 22 | 30 | 37 | 45 | 55 | 75 |
| Horsepower (HP) | 5 | 7.5 | 10 | 15 | 20 | 25 | 30 | 40 | 50 | 60 | 75 | 100 |
| ID Code of the Motor Drive (Pr00-00) | 11 | 13 | 15 | 17 | 19 | 21 | 23 | 25 | 27 | 29 | 31 | 33 |
| Rated Output Current for General Purposes (A) | 11.5 | 13 | 17 | 23 | 30 | 38 | 45 | 58 | 80 | 100 | 128 | 165 |
| Range of the Carrier Frequency | 2~ 15kHz | | | | | | 2~ 9kHz | | | 2~ 6kHz | | |
| Rated Max. Output Carrier Frequency | 8kHz | 10kHz | | | 8kHz | | | 6kHz | | | | |

00-02 Parameter Reset

Control Mode **VF** **VFPG** **SVC** **FOCPG** **TQCPG** **FOCPM** Factory Setting : 0

- Settings
- 0: No Function
 - 1: Read Only
 - 5: Direct docking mode only, contact Delta for more information. ◆
 - 8: Keypad Lock
 - 9: All parameters are reset to factory settings (50Hz)
 - 10: All parameters are reset to factory settings (60Hz)

- 📖 When it is set to 1, all parameters are read only except Pr00-00~Pr00-07 and it can be used with password setting for password protection.
- 📖 To go back to the factory setting, set Pr00-02 = 9 or 10. If it is locked by a password, enter the password to go back to the factory setting. The password will also be erased.
- 📖 When Pr.00-02=08, the keypad is locked and only Pr.00-02 and Pr00-07 can be set. To unlock the keypad, set Pr.00-02=00.

00-03 Start-up Display Selection

Control Mode **VF** **VFPG** **SVC** **FOCPG** **TQCPG** **FOCPM** Factory Setting: 0

- Settings
- 0: Display the frequency command value. (LED F)
 - 1: Display the actual output frequency (LED H)
 - 2: DC BUS voltage (V)
 - 3: Display the output current (A)
 - 4: Output voltage (E)
 - 5: User defined (see Pr.00-04)

- 📖 This parameter determines the start-up display page after power is applied to the drive.

00-04 Content of Multi-Function Display

Control Mode **VF** **VFPG** **SVC** **FOCPG** **TQCPG** **FOCPM** Factory Setting: 0

- Settings
- 0: Display the output current in A supplied to the motor
 - 1: Reserved
 - 2: Display actual output frequency (H)
 - 3: Display the actual DC BUS voltage in VDC of the AC motor drive
 - 4: Display the output voltage in VAC of terminals U, V, and W to the motor.
 - 5: Display the power factor angle in ° of terminals U, V, W to the motor.
 - 6: Display the output power in kW of terminals U, V and W to the motor.
 - 7: Display the actual motor speed in rpm (enabled when using with PG card).
 - 8: Display the estimated value of torque in % as it relates to current.
 - 9 : Display PG position
 - 10: Display the electrical angle of drive output

- 11: Display the signal of AUI1 analog input terminal in %.
Range -10V~10V corresponds to 0~100%. (1.)
- 12: Reserved
- 13: Display the signal of AUI2 analog input terminal in %.
Range -10V~10V corresponds to 0~100%. (3.)
- 14: Display the temperature of heat sink (°C)
- 15P: Display the temperature of IGBT in °C.
- 16: Display digital input status ON/OFF (i)
- 17: Display digital output status ON/OFF (o)
- 18: Display multi-step speed
- 19: The corresponding CPU pin status of digital input (i.)
- 20: The corresponding CPU pin status of digital output (o.)
- 21~23: Reserved
- 24: Output AC voltage when malfunction (8)
- 25: Output DC voltage when malfunction (8.)
- 26: Motor frequency when malfunction (h)
- 27: Output current when malfunction (4)
- 28: Output frequency when malfunction (h.)
- 29: Frequency command when malfunction
- 30: Output power when malfunction
- 31: Output torque when malfunction
- 32: Input terminal status when malfunction
- 33: Output terminal status when malfunction
- 34: Drive status when malfunction

 This parameter is to display the content on the page U of digital keypad KPC-CC01. It is helpful for getting the AC motor drive's status by this parameter.

Example 01:

| Terminal | MI8 | MI7 | MI6 | MI5 | MI4 | MI3 | MI2 | MI1 | REV | FWD |
|----------|-----|-----|-----|-----|-----|-----|-----|-----|-----|-----|
| Status | 0 | 0 | 1 | 0 | 0 | 0 | 0 | 1 | 1 | 0 |

0: OFF, 1: ON

MI1: Pr.02-01 is set to 1 (multi-step speed command 1)

MI8: Pr.02-08 is set to 8 (the 1st, 2nd acceleration/deceleration time selection)

If REV, MI1 and MI8 are ON, the value is 0000 0000 1000 01102 in binary and 0086H in HEX. Meanwhile, if Pr.00-04 is set to "16" or "19", it will display "0086" with LED U is ON on the keypad KPC-CC01. The setting 16 is the status of digital input and the setting 19 is the corresponding CPU pin status of digital input. User can set to 16 to monitor digital input status and then set to 19 to check if the wire is normal.

Example 02:

| Terminal | MO8 | MO7 | MO6 | MO5 | MO4 | MO3 | MO2 | MO1 | R2A | R1A | MRA | RA |
|----------|-----|-----|-----|-----|-----|-----|-----|-----|-----|-----|-----|----|
| Status | 0 | 0 | 0 | 0 | 1 | 0 | 0 | 0 | 0 | 1 | 1 | 0 |

RA: Pr.02-11 is set to 9 (Drive ready).

After applying the power to the AC motor drive, if there is no other abnormal status, the contact will be ON. At the meanwhile, if Pr.00-04 is set to 17 or 20, it will display 0001 with LED U is ON on the keypad. The setting 17 is the status of digital output and the setting 20 is the corresponding CPU pin status of digital output. User can set 17 to monitor the digital output status and then set to 20 to check if the wire if normal.

00-05 User Defined Coefficient K

| | | | | | | | |
|--------------|----------------------------------------|-------------|------------|--------------|--------------|--------------|--------------------|
| Control Mode | VF | VFPG | SVC | FOCPG | TQCPG | FOCPM | Factory Setting: 0 |
| Settings | Digit 4: decimal point number (0 to 3) | | | | | | |
| | Digit 0-3: 40 to 9999 | | | | | | |

- It is used digital setting method
- Digital 4: decimal point number (0: no decimal point, 1: 1 decimal point and so on.)
- Digit 0-3: 40 to 9999 (the corresponding value for the max. frequency).

Meaning of numerical order

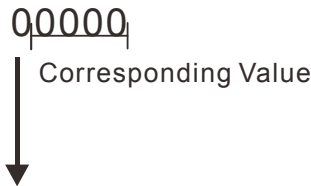

Decimal Point Number

- For example, if use uses rpm to display the motor speed and the corresponding value to the 4-pole motor 60Hz is 1800. This parameter can be set to 01800 to indicate that the corresponding value for 60Hz is 1800rpm. If the unit is rps, it can be set 10300 to indicate the corresponding value for 60Hz is 30.0 (a decimal point).
- Only frequency setting can be displayed by the corresponding value.
- After setting Pr.00-05, it won't display the unit of frequency "Hz" after returning to the main menu.

00-06 Software Version

| | | | | | | | |
|--------------|-----------|-------------|------------|--------------|--------------|--------------|-----------------------|
| Control Mode | VF | VFPG | SVC | FOCPG | TQCPG | FOCPM | Factory Setting: #.## |
| Settings | Read Only | | | | | | |

00-07 Password Input

| | | | | | | | |
|--------------|-------------------------------|-------------|------------|--------------|--------------|--------------|--------------------|
| Control Mode | VF | VFPG | SVC | FOCPG | TQCPG | FOCPM | Factory Setting: 0 |
| Settings | 1~9998 · 10000~65535 | | | | | | |
| Display | 0~2 (times of wrong password) | | | | | | |

- The function of this parameter is to input the password that is set in Pr.00-08. Input the correct password here to enable changing parameters. You are limited to a maximum of 3 attempts. After 3 consecutive failed attempts, a fault code "Password Error" will show up to force the user to restart the AC motor drive in order to try again to input the correct password.
- When forgetting password, you can decode by setting 9999 and press button  twice. Note that all the settings will be set to factory setting.

00-08 Password Set

| | | | | | | | |
|--------------|-----------------------------------------------------|-------------|------------|--------------|--------------|--------------|--------------------|
| Control Mode | VF | VFPG | SVC | FOCPG | TQCPG | FOCPM | Factory Setting: 0 |
| Settings | 1~9998 · 10000~65535 | | | | | | |
| Display | 0: No password set or successful input in Pr. 00-07 | | | | | | |
| | 1: Password has been set | | | | | | |

- To set a password to protect your parameter settings.
- If the display shows 0, no password is set or password has been correctly entered in Pr.00-07. All parameters can then be changed, including Pr.00-08.
- The first time you can set a password directly. After successful setting of password the display will show 1.

Be sure to record the password for later use.

To cancel the parameter lock, set the parameter to 0 after inputting correct password into Pr. 00-07.

The password consists of min. 2 digits and max. 5 digits.

How to make the password valid again after decoding by Pr.00-07:

Method 1: Re-input original password into Pr.00-08 (Or you can enter a new password if you want to use a changed or new one).

Method 2: After rebooting, password function will be recovered.

Password Decode Flow Chart

Password Setting

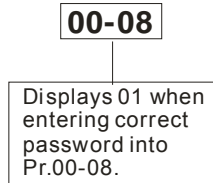

Decoding Flow Chart

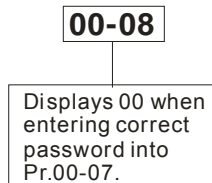

Forgetting Password

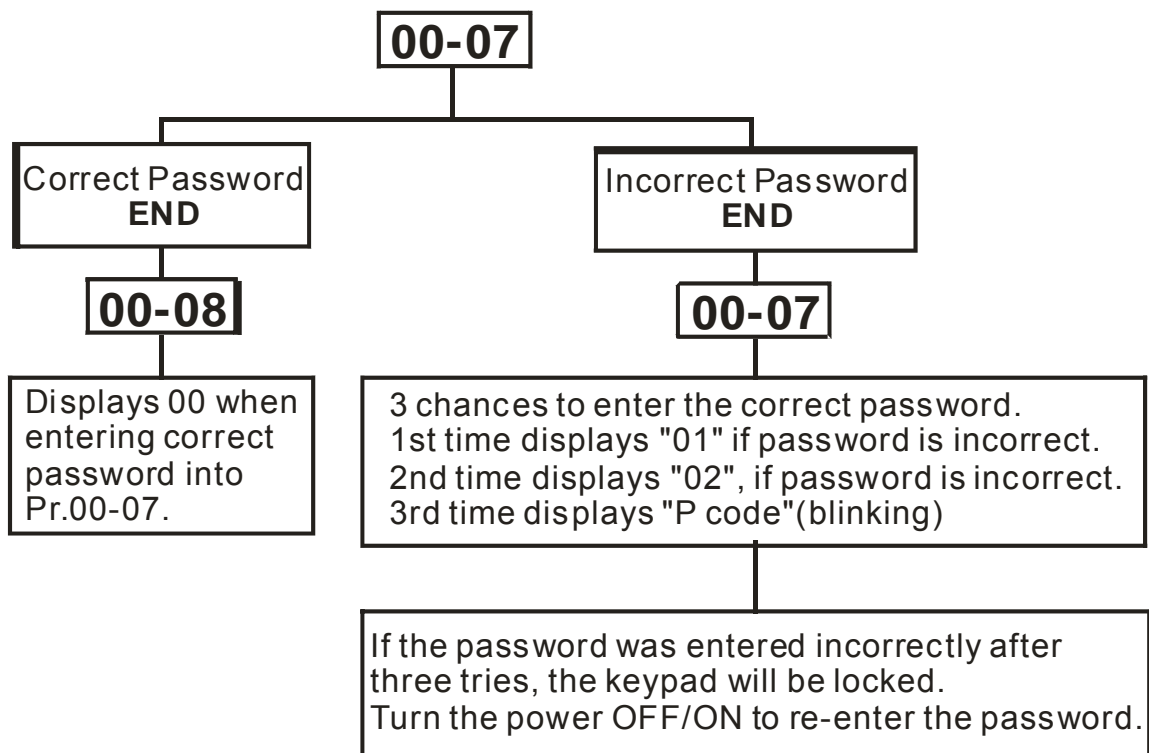
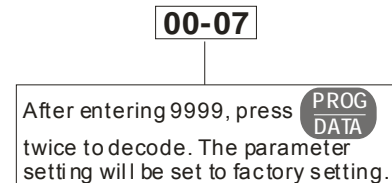

00-09 Control Mode

Control Mode **VF** **VFPG** **SVC** **FOCPG** **TQCPG** **FOCPM** Factory Setting: 0

- Settings
- 0: V/F control
 - 1: V/F control + Encoder (VFPG)
 - 2: Sensorless Vector Control (SVC)
 - 3 : FOC vector control + Encoder (FOCPG)
 - 4: Torque control + Encoder (TQCPG)
 - 8: FOC Permanent Motor Control+ Encoder (FOCPM)

This parameter determines the control method of the AC motor drive:

Setting 0: user can design V/f ratio by requirement and control multiple motors simultaneously.

Setting 1: User can use PG card with Encoder to do close-loop speed control.

Setting 2: To have optimal control characteristic by auto-tuning.

Setting 3: To increase torque and control speed precisely. (1:1000)

Setting 4: To increase accuracy for torque control.

Setting 8: To increase torque and control speed precisely. (1:1000). This setting is only for using with permanent magnet motor and others are for induction motor.

00-10 Speed Unit

Control Mode **VF** **VFPG** **SVC** **FOCPG** **TQCPG** **FOCPM** Factory Setting: 0

Settings 0:Hz
1:m/s
2:ft/s
3:: Direct docking mode only, contact Delta for more information. ◆

00-11 Output Direction Selection

Control Mode **VF** **VFPG** **SVC** **FOCPG** **TQCPG** **FOCPM** Factory Setting: 0

Settings 0: FWD: counterclockwise, REV: clockwise
1: FWD: clockwise, REV: counterclockwise

00-12 Carrier Frequency

Control Mode **VF** **VFPG** **SVC** **FOCPG** **TQCPG** **FOCPM** Factory Setting:12

Settings 2~15kHz

📖 This parameter determinates the PWM carrier frequency of the AC motor drive.

| Models | 3~ 5HP | 7.5-15HP | 20-30HP | 40-60HP | 75-100HP |
|-----------------|----------|----------|---------|---------|----------|
| Settings | 2~ 15kHz | 2~ 15kHz | 2~15kHz | 2~ 9kHz | 2~ 6kHz |
| Factory Setting | 8 kHz | 10kHz | 8kHz | 6kHz | 6kHz |

| Carrier Frequency | Acoustic Noise | Electromagnetic Noise or Leakage Current | Heat Dissipation | Current Wave |
|-------------------|----------------------------------|------------------------------------------|-----------------------|--------------|
| 2kHz | Significant ↑ ↓ Minimal | Minimal | Minimal | |
| 8kHz | | ↑ ↓ Significant | ↑ ↓ Significant | |
| 15kHz | | Significant | Significant | |



📖 From the table, we see that the PWM carrier frequency has a significant influence on the electromagnetic noise, AC motor drive heat dissipation, and motor acoustic noise.

📖 If the carrier frequency is set to be higher than the factory settings in the table above, the motor drive will derate its capacity. See Derating Capacity of Carrier Frequency (Fc) in CH02.

00-13 Auto Voltage Regulation (AVR) Function

Control Mode **VF** **VFPG** **SVC** **FOCPG** **TQCPG** **FOCPM** Factory Setting: 0

Settings 0: Enable AVR
1: Disable AVR
2: Disable AVR when deceleration stop

-  It is used to select the AVR mode. AVR is used to regulate the output voltage to the motor. For example, if V/f curve is set to AC200V/50Hz and the input voltage is from 200 to 264VAC, the output voltage won't excess AC200V/50Hz. If the input voltage is from 180 to 200V, the output voltage to the motor and the input voltage will be in direct proportion.
-  When setting Pr.00-13 to 1 during ramp to stop and used with auto accel. / decel. function, the acceleration will be smoother and faster.

 **00-14** Source of the Master Frequency Command

Control Mode **VF** **VFP** **SVC** **FOCPG** **FOCPM** Factory Setting:1

- Settings 1: RS-485 serial communication or digital keypad (KPC-CC01)
 2: External analog input (Pr. 03-00)
 3: Digital terminals input (Pr.04-00~04-15)
 4: Direct docking mode only, contact Delta for more information. ◆

 This parameter determines the drive's master frequency source.

 **00-15** Source of the Operation Command

Control Mode **VF** **VFP** **SVC** **FOCPG** **TQCPG** **FOCPM** Factory Setting:1

- Settings 1: External terminals
 2: RS-485 serial communication or digital keypad (KPC-CC01)

 ED series is shipped without digital keypad and users can use external terminals or RS-485 to control the operation command.

 When the LED PU is light, the operation command can be controlled by the optional digital keypad (KPC-CC01).

01 Basic Parameters

01-00 Maximum Output Frequency

Control Mode **VF** **VFP** **SVC** **FOCPG** **TQCPG** **FOCPM** Factory
 Setting:60.00/50.00

Settings 10.00~400.00Hz

This parameter determines the AC motor drive's Maximum Output Frequency. All the AC motor drive frequency command sources (analog inputs -10V to +10V) are scaled to correspond to the output frequency range.

01-01 1st Output Frequency Setting (base frequency/ motor's rated frequency)

Control Mode **VF** **VFP** **SVC** **FOCPG** **TQCPG** **FOCPM** Factory Setting:60.00/50.00

Settings 0.00~400.00Hz

This value should be set according to the rated frequency of the motor as indicated on the motor nameplate. If the motor is 60Hz, the setting should be 60Hz. If the motor is 50Hz, it should be set to 50Hz.

01-02 1st Output Voltage Setting(base voltage/ motor's rated voltage)

Control Mode **VF** **VFP** **SVC** **FOCPG** **TQCPG** **FOCPM** Factory
 Setting:220.0/440.0

Settings 230V series 0.1~255.0V
 460V series 0.1~510.0V

This value should be set according to the rated voltage of the motor as indicated on the motor nameplate. If the motor is 220V, the setting should be 220.0. If the motor is 200V, it should be set to 200.0.

There are many motor types in the market and the power system for each country is also difference. The economic and convenience method to solve this problem is to install the AC motor drive. There is no problem to use with the different voltage and frequency and also can amplify the original characteristic and life of the motor.

01-03 2nd Output Frequency Setting

Control Mode **VF** **VFP** Factory Setting:0.50

Settings 0.00~400.00Hz

01-04 2nd Output Voltage Setting

Control Mode **VF** **VFP** Factory Setting:5.0/10.0

Settings 230V series 0.1~255.0V
 460V series 0.1~510.0V

01-05 3rd Output Frequency Setting

Control Mode **VF** **VFP** Factory Setting:0.50

Settings 0.00~400.00Hz

01-06 3rd Output Voltage Setting

Control Mode **VF** **VFP** Factory Setting:5.0/10.0

Settings 230V series 0.1~255.0V
 460V series 0.1~510.0V

01-07 4th Output Frequency Setting

Control Mode **VF** **VFP** **SVC** **FOCPG** **TQCPG** Factory Setting:0.00

Settings 0.00~400.00Hz

01-08 4th Output Voltage Setting

Control Mode **VF** **VFP** Factory Setting:5.0/10.0

Settings 230V series 0.1~255.0V
460V series 0.1~510.0V

- V/f curve setting is usually set by the motor's allowable loading characteristics. Pay special attention to the motor's heat dissipation, dynamic balance, and bearing lubricity, if the loading characteristics exceed the loading limit of the motor.
- For the V/f curve setting, it should be $Pr.01-01 \geq Pr.01-03 \geq Pr.01-05 \geq Pr.01-07$. There is no limit for the voltage setting, but a high voltage at the low frequency may cause motor damage, overheat, stall prevention or over-current protection. Therefore, please use the low voltage at the low frequency to prevent motor damage.

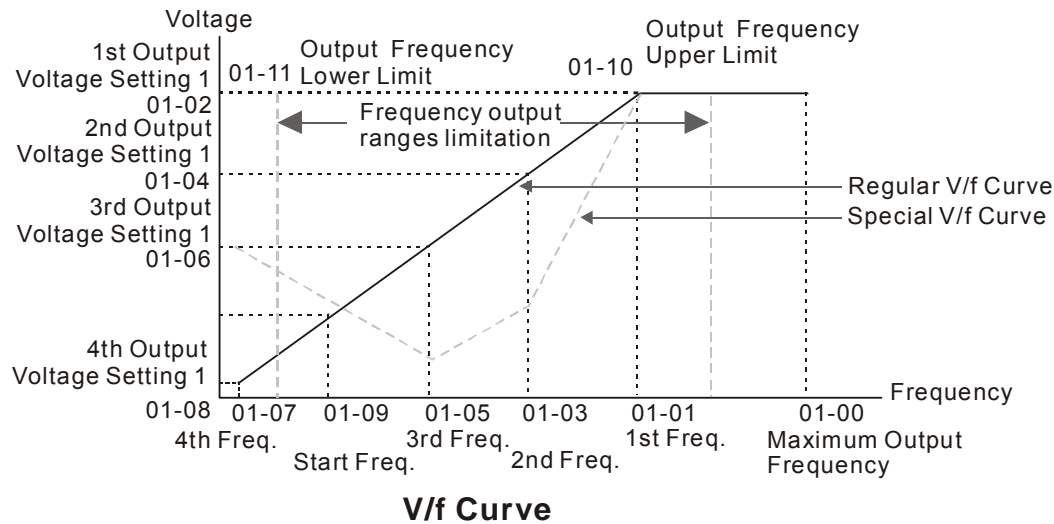

01-09 Starting Frequency

Control Mode **VF** **VFP** **SVC** **FOCP** **FOCPM** Factory Setting:0.50

Settings 0.00~400.00Hz

- When the starting frequency (Pr01-09) is larger than the output frequency (Pr01-11), the frequency output will start when the starting frequency (Pr01-09) reached the F command.

When min. output frequency > start frequency When start frequency > min. output frequency

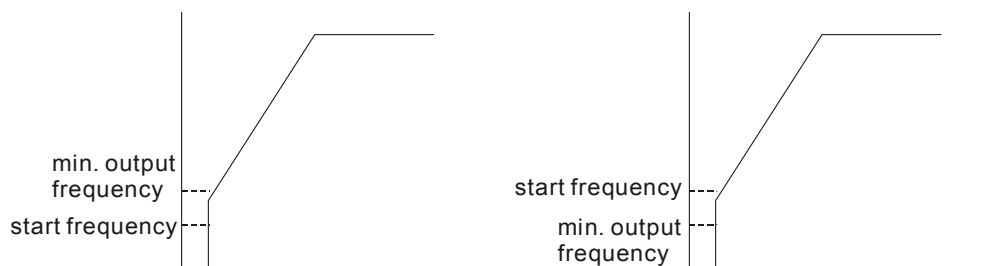

01-10 Output Frequency Upper Limit

Control Mode **VF** **VFP** **SVC** **FOCP** **FOCPM** Factory Setting:120.00

Settings 0.00~400.00Hz





01-11 Output Frequency Lower Limit

Control Mode **VF** **VFP** **SVC** **FOCP** **FOCPM** Factory Setting:0.00

Settings 0.00~400.00Hz

- The upper/lower output frequency setting is used to limit the actual output frequency. If the frequency setting is lower than the start-up frequency, it will run with zero speed. If the frequency setting is higher than the upper limit, it will runs with the upper limit frequency. If output frequency lower limit > output frequency upper limit, this function is invalid.

| | | | | | | | |
|---|--------------|----------------|-------------|------------|--------------|--------------|----------------------|
| ↘ | 01-12 | Accel. Time 1 | | | | | |
| | Control Mode | VF | VFPG | SVC | FOCPG | FOCPM | Factory Setting:3.00 |
| | Settings | 0.00~600.00sec | | | | | |
| ↘ | 01-13 | Decel. Time 1 | | | | | |
| | Control Mode | VF | VFPG | SVC | FOCPG | FOCPM | Factory Setting:2.00 |
| | Settings | 0.00~600.00sec | | | | | |
| ↘ | 01-14 | Accel. Time 2 | | | | | |
| | Control Mode | VF | VFPG | SVC | FOCPG | FOCPM | Factory Setting:3.00 |
| | Settings | 0.00~600.00sec | | | | | |
| ↘ | 01-15 | Decel. Time 2 | | | | | |
| | Control Mode | VF | VFPG | SVC | FOCPG | FOCPM | Factory Setting:2.00 |
| | Settings | 0.00~600.00sec | | | | | |
| ↘ | 01-16 | Accel. Time 3 | | | | | |
| | Control Mode | VF | VFPG | SVC | FOCPG | FOCPM | Factory Setting:3.00 |
| | Settings | 0.00~600.00sec | | | | | |
| ↘ | 01-17 | Decel. Time 3 | | | | | |
| | Control Mode | VF | VFPG | SVC | FOCPG | FOCPM | Factory Setting:2.00 |
| | Settings | 0.00~600.00sec | | | | | |
| ↘ | 01-18 | Accel. Time 4 | | | | | |
| | Control Mode | VF | VFPG | SVC | FOCPG | FOCPM | Factory Setting:3.00 |
| | Settings | 0.00~600.00sec | | | | | |
| ↘ | 01-19 | Decel. Time 4 | | | | | |
| | Control Mode | VF | VFPG | SVC | FOCPG | FOCPM | Factory Setting:2.00 |
| | Settings | 0.00~600.00sec | | | | | |

-  The Acceleration Time is used to determine the time required for the AC motor drive to ramp from 0Hz to Maximum Output Frequency (Pr.01-00).
-  The Deceleration Time is used to determine the time require for the AC motor drive to decelerate from the Maximum Output Frequency (Pr.01-00) down to 0Hz.
-  The Acceleration/Deceleration Time 1, 2, 3, 4 are selected according to the Multi-function Input Terminals settings. The factory settings are acceleration time 1 and deceleration time 1.
-  The larger against torque and inertia torque of the load and the accel./ decel. time setting is less than the necessary value, it will enable torque limit and stall prevention function. When it happens, actual accel./decel. time will be longer than the action above.

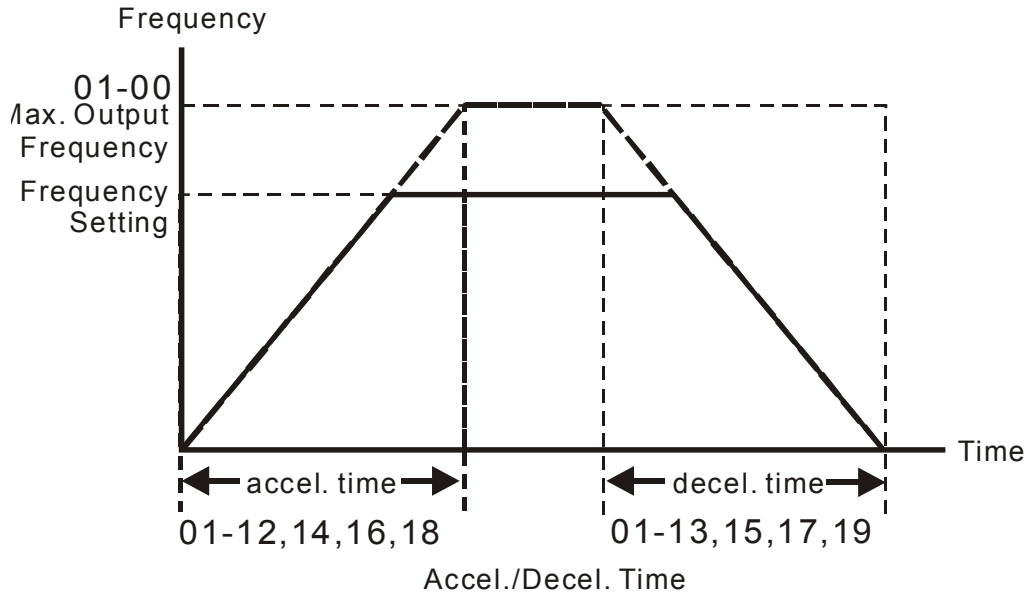

- **01-20** JOG Acceleration Time
- **01-21** JOG Deceleration Time

Control Mode **VF VFPG SVC FOC PG FOC PM** Factory Setting:1.00
 Settings 0.00~600.00sec

- 📖 Both external terminal JOG and key “JOG” on the keypad can be used. When the jog command is ON, the AC motor drive will accelerate from 0Hz (Pr01-07) to jog frequency (Pr.01-22). When the jog command is OFF, the AC motor drive will decelerate from Jog Frequency to zero. The used Accel./ Decel. time is set by the Jog Accel./ Decel. time (Pr.01-20, Pr.01-21).
- 📖 The JOG command can't be executed when the AC motor drive is running. In the same way, when the JOG command is executing, other operation commands are invalid except forward/reverse commands and STOP key on the digital keypad.

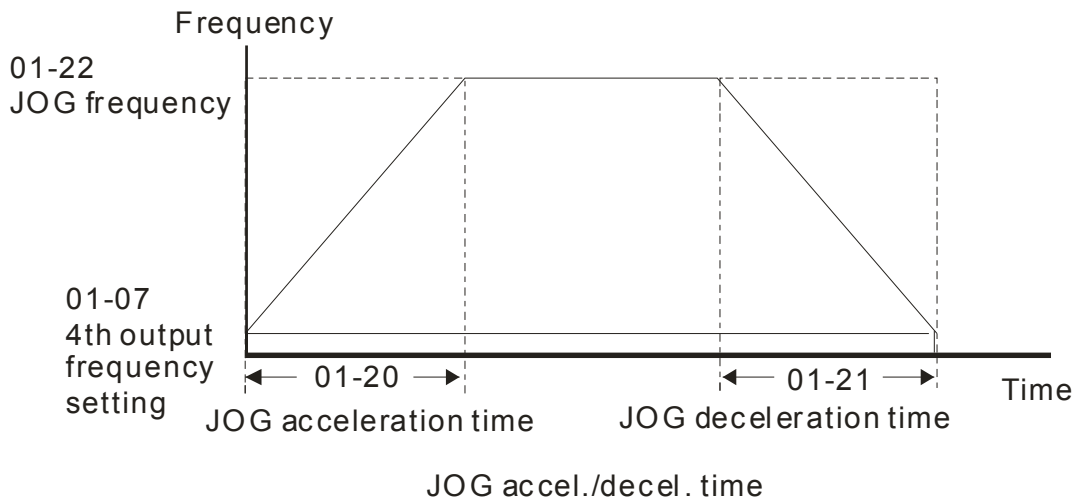

- **01-22** JOG Frequency
- Control Mode **VF VFPG SVC FOC PG TQCPG FOC PM** Factory Setting:6.00
 Settings 0.00~400.00Hz

➤ **01-23** Switch Frequency between 1st/4th Accel/ decel

Control Mode **VF** **VFPG** **SVC** **FOCPG** **FOCPM** Factory Setting:0.00
 Settings 0.00~400.00Hz

- 📖 This parameter selects the frequency point for transition from acceleration/deceleration time 1 to acceleration/deceleration time 4.
- 📖 The transition from acceleration/deceleration time 1 to acceleration/deceleration time 4, may also be enabled by the external terminals (Pr. 02-01 to 02-08). The external terminal has priority over Pr. 01-23.

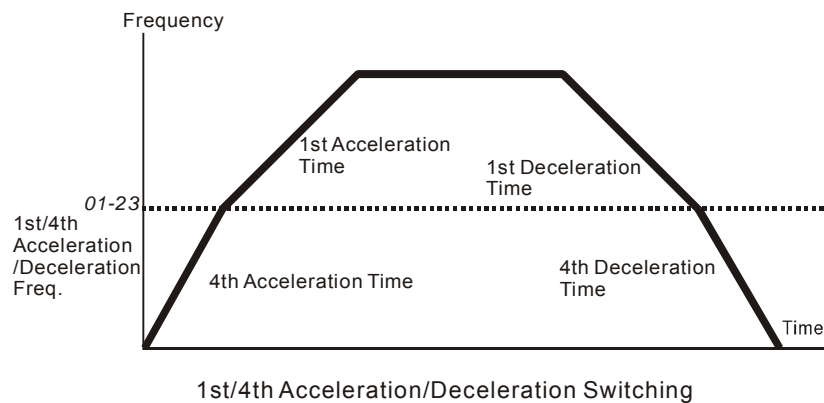

➤ **01-24** S-curve for Acceleration Departure Time S1

➤ **01-25** S-curve for Acceleration Arrival Time S2

➤ **01-26** S-curve for Deceleration Departure Time S3

➤ **01-27** S-curve for Deceleration Arrival Time S4

➤ **01-30** S-curve for Deceleration Arrival Time S5

Control Mode **VF** **VFPG** **SVC** **FOCPG** **FOCPM** Factory Setting:1.00
 Settings 0.00~25.00sec

➤ **01-29** Switch Frequency for S3/S4 Changes to S5

Control Mode **VF** **VFPG** **SVC** **FOCPG** **FOCPM** Factory Setting:0.00
 Settings 0.00~400.00Hz

- 📖 It is used to give the smoothest transition between speed changes. The accel./ decel. curve can adjust the S-curve of the accel./decel. When it is enabled, the drive will have different accel./decel. curve by the accel./ decel. time.
- 📖 The Actual Accel. Time = selected accel. Time + (Pr.01-24 + Pr.01-25)/2
 The Actual Decel. Time = selected decel. Time + (Pr.01-26 + Pr.01-27 + Pr.01-30*2)/2
- 📖 Pr.01-29 is used to set the switch frequency between S4 and S5 for smooth stop.
- 📖 It is recommended to set this parameter to the leveling speed of elevator.

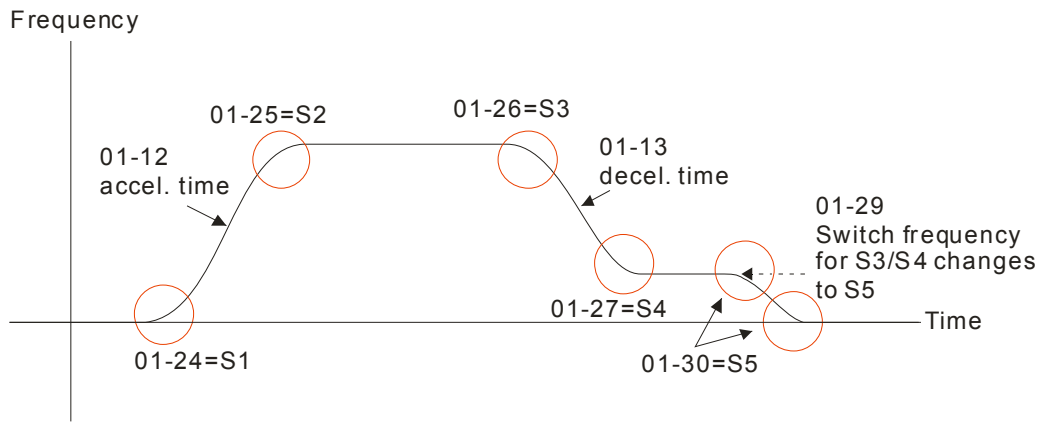

01-28 Mode Selection when Frequency < Fmin

Control Mode **VF** **VFP** **SVC** Factory Setting:1

- Settings 0: Output Waiting
 1: Zero-speed operation
 2: Fmin (4th output frequency setting)

- 📖 When the AC motor drive is at 0Hz, it will operate by this parameter.
- 📖 When it is set to 1 or 2, voltage will be output by Fmin corresponding output voltage (Pr.01-08).

⚡ **01-31** Deceleration Time when Operating without RUN Command

Control Mode **VF** **VFP** **SVC** **FOCP** **FOCPM** Factory Setting:2.00

Settings 0.00~600.00sec

- 📖 The AC motor drive will stop by the setting of this parameter when canceling RUN command. Refer to the figure in Pr.01-29 for details.

⚡ **01-32** Direct docking mode only ◆

Control Mode **VF** **VFP** **SVC** **FOCP** **FOCPM** Factory Setting:

Settings Contact Delta for more information

02 Digital Input/ Output Parameters

02-00

2-wire/3-wire Operation Control

Control Mode **VF** **VFP** **SVC** **FOCP** **TQCP** **FOCP**

Factory Setting: 0

- Settings 0: FWD/STOP, REV/STOP
 1: FWD/STOP, REV/STOP (Line Start Lockout)
 2: RUN/STOP, REV/FWD
 3: RUN/STOP, REV/FWD (Line Start Lockout)
 4: 3-wire
 5: 3-wire (Line Start Lockout)

- Three of the six methods include a "Line Start Lockout" feature. When line start lockout is enabled, the drive will not run once applying the power. The Line Start Lockout feature doesn't guarantee the motor will never start under this condition. It is possible the motor may be set in motion by a malfunctioning switch.
- This parameter is used to control operation from external terminals. There are three different control modes.

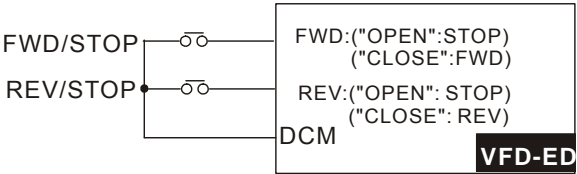
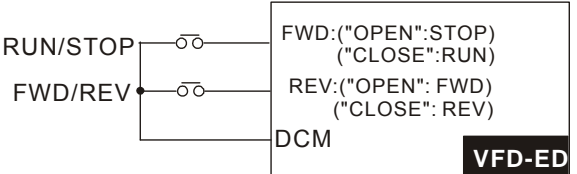
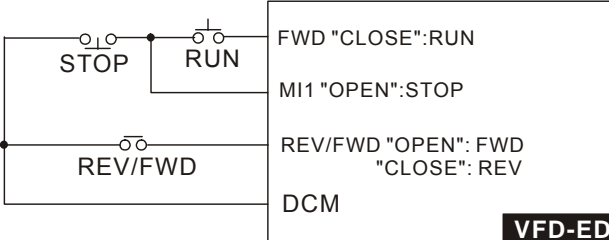
| 02-00 | Control Circuits of the External Terminal |
|--------------------------------------------------------------|--------------------------------------------------------------------------------------|
| 0, 1 2-wire operation control (1) FWD/STOP REV/STOP |  |
| 2, 3 2-wire operation control (2) RUN/STOP REV/FWD |  |
| 4, 5 3-wire operation control |  |

| | | |
|--------------|----------------------------------------------------------------------------------------------------------------------------------------------------------------------------------------------------------------|--------------------|
| 02-01 | Multi-Function Input Command 1 (MI1) (it is Stop terminal for 3-wire operation) | Factory Setting:1 |
| 02-02 | Multi-Function Input Command 2 (MI2) | Factory Setting:2 |
| 02-03 | Multi-Function Input Command 3 (MI3) | Factory Setting:3 |
| 02-04 | Multi-Function Input Command 4 (MI4) | Factory Setting:4 |
| 02-05 | Multi-Function Input Command 5 (MI5) | Factory Setting: 0 |
| 02-06 | Multi-Function Input Command 6 (MI6) | Factory Setting: 0 |
| 02-07 | Multi-Function Input Command 7 (MI7) | Factory Setting: 0 |
| 02-08 | Multi-Function Input Command 8 (MI8) When JP1 on the control board is inserted, MI8 functions acc. to Pr02-08. When JP1 on the control board is removed, MI8 is always "enable", independent of Pr02-08. | Factory Setting:40 |

| Settings | Control Mode | VF | VFPG | SVC | FOCPG | TQCPG | FOCPM |
|----------------------------------------------------------|--------------|-----------------------|-----------------------|-----------------------|-----------------------|-----------------------|-----------------------|
| 0:0: no function | | <input type="radio"/> | <input type="radio"/> | <input type="radio"/> | <input type="radio"/> | <input type="radio"/> | <input type="radio"/> |
| 1: multi-step speed command 1 | | <input type="radio"/> | <input type="radio"/> | <input type="radio"/> | <input type="radio"/> | | <input type="radio"/> |
| 2: multi-step speed command 2 | | <input type="radio"/> | <input type="radio"/> | <input type="radio"/> | <input type="radio"/> | | <input type="radio"/> |
| 3: multi-step speed command 3 | | <input type="radio"/> | <input type="radio"/> | <input type="radio"/> | <input type="radio"/> | | <input type="radio"/> |
| 4: multi-step speed command 4 | | <input type="radio"/> | <input type="radio"/> | <input type="radio"/> | <input type="radio"/> | | <input type="radio"/> |
| 5: Reset | | <input type="radio"/> | <input type="radio"/> | <input type="radio"/> | <input type="radio"/> | <input type="radio"/> | <input type="radio"/> |
| 6: JOG command | | <input type="radio"/> | <input type="radio"/> | <input type="radio"/> | <input type="radio"/> | | <input type="radio"/> |
| 7: acceleration/deceleration speed inhibit | | <input type="radio"/> | <input type="radio"/> | <input type="radio"/> | <input type="radio"/> | | <input type="radio"/> |
| 8: the 1st, 2nd acceleration/deceleration time selection | | <input type="radio"/> | <input type="radio"/> | <input type="radio"/> | <input type="radio"/> | | <input type="radio"/> |
| 9: the 3rd, 4th acceleration/deceleration time selection | | <input type="radio"/> | <input type="radio"/> | <input type="radio"/> | <input type="radio"/> | | <input type="radio"/> |
| 10: EF input (07-28) | | <input type="radio"/> | <input type="radio"/> | <input type="radio"/> | <input type="radio"/> | <input type="radio"/> | <input type="radio"/> |
| 11: Reserved | | | | | | | |
| 12: Stop output | | <input type="radio"/> | <input type="radio"/> | <input type="radio"/> | <input type="radio"/> | <input type="radio"/> | <input type="radio"/> |
| 13~14: Reserved | | | | | | | |
| 15: AUI1 operation speed command form AUI1 | | <input type="radio"/> | <input type="radio"/> | <input type="radio"/> | <input type="radio"/> | | <input type="radio"/> |
| 16: Reserved | | <input type="radio"/> | <input type="radio"/> | <input type="radio"/> | <input type="radio"/> | | <input type="radio"/> |
| 17: AUI2 operation speed command form AUI2 | | <input type="radio"/> | <input type="radio"/> | <input type="radio"/> | <input type="radio"/> | | <input type="radio"/> |
| 18: Emergency Stop (07-28) | | <input type="radio"/> | <input type="radio"/> | <input type="radio"/> | <input type="radio"/> | <input type="radio"/> | <input type="radio"/> |
| 19~23: Reserved | | | | | | | |

| | | | | | | |
|-------------------------------------------------|-----------------------|-----------------------|-----------------------|-----------------------|-----------------------|-----------------------|
| 24: FWD JOG Command | <input type="radio"/> | <input type="radio"/> | <input type="radio"/> | <input type="radio"/> | <input type="radio"/> | <input type="radio"/> |
| 25: REV JOG Command | <input type="radio"/> | <input type="radio"/> | <input type="radio"/> | <input type="radio"/> | <input type="radio"/> | <input type="radio"/> |
| 26: Reserved | | | | | | |
| 27: ASR1/ASR2 selection | <input type="radio"/> | <input type="radio"/> | <input type="radio"/> | <input type="radio"/> | <input type="radio"/> | <input type="radio"/> |
| 28: Emergency stop (EF1) (Motor coasts to stop) | <input type="radio"/> | <input type="radio"/> | <input type="radio"/> | <input type="radio"/> | <input type="radio"/> | <input type="radio"/> |
| 29~30: Reserved | | | | | | |
| 31: High torque bias (by Pr.07-21) | <input type="radio"/> | <input type="radio"/> | <input type="radio"/> | <input type="radio"/> | <input type="radio"/> | <input type="radio"/> |
| 32: Middle torque bias (by Pr.07-22) | <input type="radio"/> | <input type="radio"/> | <input type="radio"/> | <input type="radio"/> | <input type="radio"/> | <input type="radio"/> |
| 33: Low torque bias (by Pr.07-23) | <input type="radio"/> | <input type="radio"/> | <input type="radio"/> | <input type="radio"/> | <input type="radio"/> | <input type="radio"/> |
| 34~37: Reserved | | | | | | |
| 38: Disable write EEPROM function | <input type="radio"/> | <input type="radio"/> | <input type="radio"/> | <input type="radio"/> | <input type="radio"/> | <input type="radio"/> |
| 39: Torque command direction | | | | | <input type="radio"/> | |
| 40: Enable drive function | <input type="radio"/> | <input type="radio"/> | <input type="radio"/> | <input type="radio"/> | <input type="radio"/> | <input type="radio"/> |
| 41: Detection of magnetic contactor | | <input type="radio"/> | <input type="radio"/> | <input type="radio"/> | <input type="radio"/> | <input type="radio"/> |
| 42: Mechanical brake 1 | <input type="radio"/> | <input type="radio"/> | <input type="radio"/> | <input type="radio"/> | <input type="radio"/> | <input type="radio"/> |
| 43: EPS function (Emergency Power System) | <input type="radio"/> | <input type="radio"/> | <input type="radio"/> | <input type="radio"/> | <input type="radio"/> | <input type="radio"/> |
| 44: Mechanical brake 2 | <input type="radio"/> | <input type="radio"/> | <input type="radio"/> | <input type="radio"/> | <input type="radio"/> | <input type="radio"/> |
| 45~51: Direct docking mode only ◆ | | | | | | |

 This parameter selects the functions for each multi-function terminal.

 If Pr.02-00 is set to 3-wire operation control. Terminal MI1 is for STOP terminal. Therefore, MI1 is not allowed for any other operation.

| Settings | Functions | Descriptions |
|----------|-----------------------------------------|----------------------------------------------------------------------------------------------------------------------------------------------------------------------------------------------------------------------------------------------------------------------|
| 0 | No Function | |
| 1 | Multi-step speed command 1 | 15 step speeds could be conducted through the digital statuses of the 4 terminals, and 17 in total if the master speed and JOG are included. (Refer to Pr. 04-00~04-14) When using communication to control the multi-step speed, setting 1 to 4 will be invalid. |
| 2 | Multi-step speed command 2 | |
| 3 | Multi-step speed command 3 | |
| 4 | Multi-step speed command 4 | |
| 5 | Reset | After the error of the drive is eliminated, use this terminal to reset the drive. |
| 6 | JOG Command | JOG operation |
| 7 | Acceleration/deceleration Speed Inhibit | When this function is enabled, acceleration and deceleration is stopped and the AC motor drive starts to accel./decel. from the inhibit point. |

| | | |
|-----------------|-----------------------------------------------------------------------------------|-----------------------------------------------------------------------------------------------------------------------------------------------------------------------------------------------------------------------------------------------------------------------------------------------------------------------------------------------------------------------------------------------------------------------------------------------|
| 8 | The 1 st , 2 nd acceleration or deceleration time selection | The acceleration/deceleration time of the drive could be selected from this function or the digital statuses of the terminals; there are 4 acceleration/deceleration speeds in total for selection. Bit Bit Descriptions 0 1 0 0 First acceleration/deceleration time When output frequency is less than Pr.01-23 (Switch Frequency between 1st/4th Accel/decel), it will output 4 th accel/decel time. |
| 9 | The 3 rd , 4 th acceleration or deceleration time selection | 0 1 2 nd accel./decel. time 1 0 3 rd accel./decel. time 1 1 4 th accel./decel. time If the drive receives STOP command, it will decelerate to stop by Pr.01-31. |
| 10 | EF Input | External fault input terminal and decelerates by Pr.07-28. (EF fault will be recorded) |
| 11: Reserved | | |
| 12 | Stop output | When this function is enabled, the drive output will stop immediately and the motor is free run. When this function is disabled, the drive will accelerate to the frequency setting. |
| 13~14: Reserved | | |
| 15 | Operation speed command form AUI1 | When the source of operation speed command is set to AUI1, ACI and AUI2 at the same time and two or above terminals are ON, the priority is AUI1>ACI>AUI2. When this function is enabled, the source of the frequency will force to be AUI1. |
| 16: Reserved | | |
| 17 | Operation speed command form AUI2 | When this function is enabled, the source of the frequency will force to be AUI2. |
| 18 | Emergency Stop | When this function is enabled, the drive will ramp to stop by Pr.07-28 setting. |
| 19~23: Reserved | | |
| 24 | FWD JOG command | When this function is enabled, the drive will execute forward Jog command. |
| 25 | REV JOG command | When this function is enabled, the drive will execute reverse Jog command. |
| 26: Reserved | | |
| 27 | ASR1/ASR2 selection | ON: speed will be adjusted by ASR 2 setting. OFF: speed will be adjusted by ASR 1 setting. |
| 28 | Emergency stop (EF1) (Motor coasts to stop) | When it is ON, the drive will execute emergency stop. (it will have fault code record) |

| 29~30: Reserved | | | | | | | | | | | | | | | | | | | | | | | | | | | | | | | | | | | | | | |
|-----------------|---------------------------------------|------------------------------------------------------------------------------------------------------------------------------------------------------------------------------------------------------------------------------------------------------------------------------------------------------------------------------------------------------------------------------------------------------------------------------------------------------------------------------------------------------------------------------------------------------------------------------------------------------------------------------------------------------------------------------------------------------------------------------------------------------------------------------------------------------------------------------------------------------------------------------------------------------------------------------------|-------------------|-------------|----|-------------|-----|-----|-----|-----|-----|-----|----|-------|-----|----|-----|-------|-----|----|----|-------------|----|-----|-----|-------|----|-----|----|-------------|----|----|-----|-------------|----|----|----|-------------------|
| 31 | High torque bias | <p>When Pr.07-19 is set to 3:</p> <p>The high torque bias is according to the Pr.07-21 setting.</p> <p>The middle torque bias is according to the Pr.07-22 setting.</p> <p>The low torque bias is according to the Pr.07-23 setting.</p> <table border="1"> <thead> <tr> <th>31</th> <th>32</th> <th>33</th> <th>Torque Bias</th> </tr> </thead> <tbody> <tr> <td>OFF</td> <td>OFF</td> <td>OFF</td> <td>N/A</td> </tr> <tr> <td>OFF</td> <td>OFF</td> <td>ON</td> <td>07-23</td> </tr> <tr> <td>OFF</td> <td>ON</td> <td>OFF</td> <td>07-22</td> </tr> <tr> <td>OFF</td> <td>ON</td> <td>ON</td> <td>07-23+07-22</td> </tr> <tr> <td>ON</td> <td>OFF</td> <td>OFF</td> <td>07-21</td> </tr> <tr> <td>ON</td> <td>OFF</td> <td>ON</td> <td>07-21+07-23</td> </tr> <tr> <td>ON</td> <td>ON</td> <td>OFF</td> <td>07-21+07-22</td> </tr> <tr> <td>ON</td> <td>ON</td> <td>ON</td> <td>07-21+07-22+07-23</td> </tr> </tbody> </table> | 31 | 32 | 33 | Torque Bias | OFF | OFF | OFF | N/A | OFF | OFF | ON | 07-23 | OFF | ON | OFF | 07-22 | OFF | ON | ON | 07-23+07-22 | ON | OFF | OFF | 07-21 | ON | OFF | ON | 07-21+07-23 | ON | ON | OFF | 07-21+07-22 | ON | ON | ON | 07-21+07-22+07-23 |
| 31 | 32 | | 33 | Torque Bias | | | | | | | | | | | | | | | | | | | | | | | | | | | | | | | | | | |
| OFF | OFF | | OFF | N/A | | | | | | | | | | | | | | | | | | | | | | | | | | | | | | | | | | |
| OFF | OFF | ON | 07-23 | | | | | | | | | | | | | | | | | | | | | | | | | | | | | | | | | | | |
| OFF | ON | OFF | 07-22 | | | | | | | | | | | | | | | | | | | | | | | | | | | | | | | | | | | |
| OFF | ON | ON | 07-23+07-22 | | | | | | | | | | | | | | | | | | | | | | | | | | | | | | | | | | | |
| ON | OFF | OFF | 07-21 | | | | | | | | | | | | | | | | | | | | | | | | | | | | | | | | | | | |
| ON | OFF | ON | 07-21+07-23 | | | | | | | | | | | | | | | | | | | | | | | | | | | | | | | | | | | |
| ON | ON | OFF | 07-21+07-22 | | | | | | | | | | | | | | | | | | | | | | | | | | | | | | | | | | | |
| ON | ON | ON | 07-21+07-22+07-23 | | | | | | | | | | | | | | | | | | | | | | | | | | | | | | | | | | | |
| 32 | Middle torque bias | | | | | | | | | | | | | | | | | | | | | | | | | | | | | | | | | | | | | |
| 33 | Low torque bias | | | | | | | | | | | | | | | | | | | | | | | | | | | | | | | | | | | | | |
| 34~37: Reserved | | | | | | | | | | | | | | | | | | | | | | | | | | | | | | | | | | | | | | |
| 38 | Disable write EEPROM function | When this function is enabled, you can't write into EEPROM. | | | | | | | | | | | | | | | | | | | | | | | | | | | | | | | | | | | | |
| 39 | Torque command direction | When this function is enabled, you can't write into EEPROM. | | | | | | | | | | | | | | | | | | | | | | | | | | | | | | | | | | | | |
| 40 | Enable drive function | When Pr.07-13=2 and analog input is ACI or unipolar AUI, torque command direction is decided by this terminal. | | | | | | | | | | | | | | | | | | | | | | | | | | | | | | | | | | | | |
| 41 | Detection of magnetic contactor | When this function is enabled, the drive function can be executed. This function can be used with multi-function output (setting Pr.02-11~Pr.02-14 to 15) and (Pr.02-31 and Pr.02-32). | | | | | | | | | | | | | | | | | | | | | | | | | | | | | | | | | | | | |
| 42 | Mechanical brake 1 | <p>This terminal is used for the feedback signal of magnetic contactor ON/OFF.</p> <p>When drive receives RUN command, the corresponding output terminal (setting 15) will be enabled after Pr.02-31 time. It will check if this function is enabled within the detection time (Pr.02-36). If NOT, the fault of mechanical brake occurs and fault code "MCF" will be displayed.</p> | | | | | | | | | | | | | | | | | | | | | | | | | | | | | | | | | | | | |
| 43 | EPS function (Emergency Power System) | If power is cut during running, the drive will stop when DC bus voltage is less than low voltage level. After power is cut, drive will run by the frequency depend on EPS when EPS is applied and this function is ON. | | | | | | | | | | | | | | | | | | | | | | | | | | | | | | | | | | | | |
| 44 | Mechanical brake 2 | <p>This terminal is used for the feedback signal of magnetic contactor ON/OFF.</p> <p>When drive receives RUN command, the corresponding output terminal (setting 15) will be enabled after Pr.02-31 time. It will check if this function is enabled within the detection time (Pr.02-36). If NOT, the fault of mechanical brake occurs and fault code "MCF" will be displayed.</p> | | | | | | | | | | | | | | | | | | | | | | | | | | | | | | | | | | | | |

| | | |
|-------|-------------------------------|-------------------------------------|
| 45~51 | Direct docking mode only ◆ | Contact Delta for more information. |
|-------|-------------------------------|-------------------------------------|

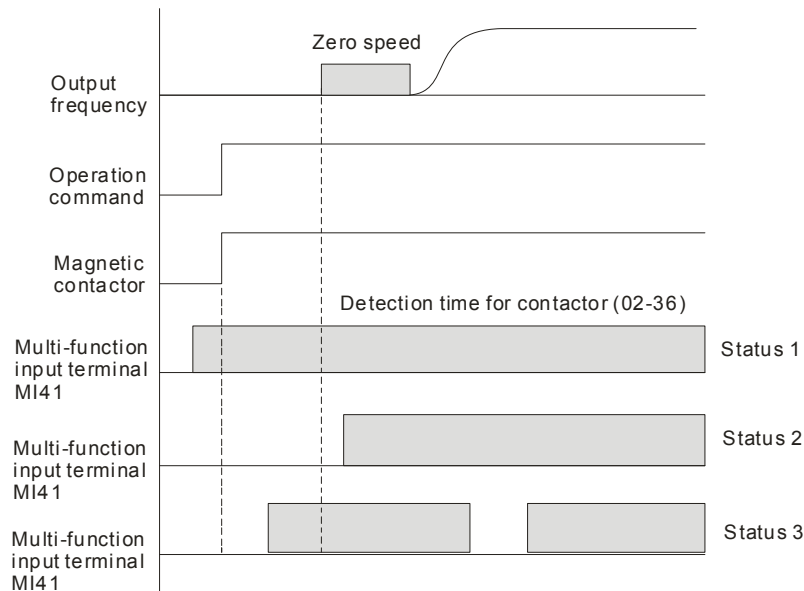
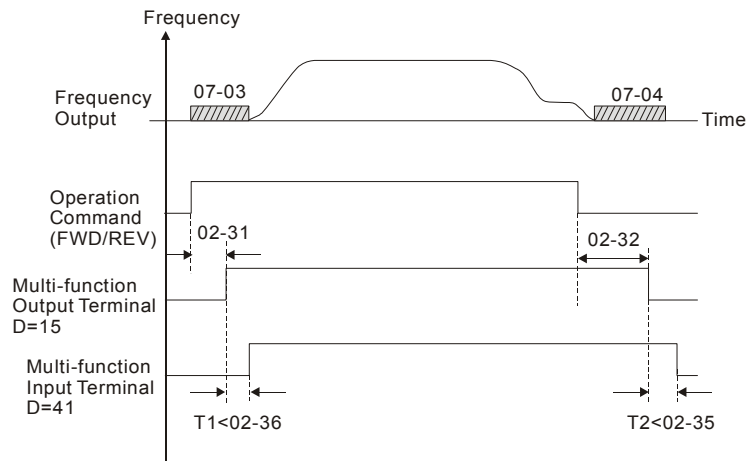

⚡ **02-09** Digital Input Response Time

Control Mode **VF VFPG SVC FOC PG TQCPG FOC PM** Factory Setting: 0.005
 Settings 0.001~30.000sec

📖 This parameter is used for digital input terminal signal delay and confirmation. The delay time is confirmation time to prevent some uncertain interferences that would result in error (except for the counter input) in the input of the digital terminals (FWD, REV and MI1~8). Under this condition, confirmation for this parameter could be improved effectively, but the response time will be somewhat delayed.

⚡ **02-10** Digital Input Operation Direction

Control Mode **VF VFPG SVC FOC PG TQCPG FOC PM** Factory Setting: 0
 Settings 0~65535

- 📖 This parameter is used to set the input signal level and it won't be affected by the SINK/SOURCE status.
- 📖 Bit0 is for FWD terminal, bit1 is for REV terminal and bit2 to bit9 is for MI1 to MI8.

 User can change terminal status by communicating.

For example, MI1 is set to 1 (multi-step speed command 1), MI2 is set to 2 (multi-step speed command 2). Then the forward + 2nd step speed command=1001(binary) =9 (Decimal). Only need to set Pr.02-10=9 by communication and it can forward with 2nd step speed. It doesn't need to wire any multi-function terminal.

| | | | | | | | | | |
|------|------|------|------|------|------|------|------|------|------|
| bit9 | bit8 | bit7 | bit6 | bit5 | bit4 | bit3 | bit2 | bit1 | bit0 |
| MI8 | MI7 | MI6 | MI5 | MI4 | MI3 | MI2 | MI1 | REV | FWD |

| | | | |
|---|--------------|--------------------------------------------------|--------------------|
| ↘ | 02-11 | Multi-function Output 1: RA, RB, RC (Relay 1) | Factory Setting:11 |
| ↘ | 02-12 | Multi-function Output 2: MRA, MRB, MRC (Relay 2) | Factory Setting:1 |
| ↘ | 02-13 | Multi-function Output 3: R1A, R12C (Realy 3) | |
| ↘ | 02-14 | Multi-function Output 4: R2A, R12C (Realy 4) | |
| ↘ | 02-15 | Multi-function Output 5: MO1 | |
| ↘ | 02-16 | Multi-function Output 6: MO2 | |
| ↘ | 02-17 | Reserved | |
| ↘ | 02-18 | Reserved | |
| ↘ | 02-19 | Reserved | |
| ↘ | 02-20 | Reserved | |
| ↘ | 02-21 | Reserved | |
| ↘ | 02-22 | Reserved | |

Factory Setting: 0

| Settings | Control Mode | VF | VFPG | SVC | FOCPG | TQCPG | FOCPM |
|---------------------------------------------------|--------------|-----------------------|-----------------------|-----------------------|-----------------------|-----------------------|-----------------------|
| 0: No function | | <input type="radio"/> | <input type="radio"/> | <input type="radio"/> | <input type="radio"/> | <input type="radio"/> | <input type="radio"/> |
| 1: Operation indication | | <input type="radio"/> | <input type="radio"/> | <input type="radio"/> | <input type="radio"/> | <input type="radio"/> | <input type="radio"/> |
| 2: Operation speed attained | | <input type="radio"/> | <input type="radio"/> | <input type="radio"/> | <input type="radio"/> | <input type="radio"/> | <input type="radio"/> |
| 3: Desired frequency attained 1 (Pr.02-25, 02-26) | | <input type="radio"/> | <input type="radio"/> | <input type="radio"/> | <input type="radio"/> | <input type="radio"/> | <input type="radio"/> |
| 4: Desired frequency attained 2 (Pr.02-27, 02-28) | | <input type="radio"/> | <input type="radio"/> | <input type="radio"/> | <input type="radio"/> | <input type="radio"/> | <input type="radio"/> |
| 5: Zero Speed(frequency command | | <input type="radio"/> | <input type="radio"/> | <input type="radio"/> | <input type="radio"/> | <input type="radio"/> | <input type="radio"/> |
| 6: Zero speed with stop (frequency command) | | <input type="radio"/> | <input type="radio"/> | <input type="radio"/> | <input type="radio"/> | <input type="radio"/> | <input type="radio"/> |
| 7: Over torque (OT1) (Pr.06-05~06-07) | | <input type="radio"/> | <input type="radio"/> | <input type="radio"/> | <input type="radio"/> | <input type="radio"/> | <input type="radio"/> |
| 8: Over torque (OT2) (Pr.06-08~06-10) | | <input type="radio"/> | <input type="radio"/> | <input type="radio"/> | <input type="radio"/> | <input type="radio"/> | <input type="radio"/> |
| 9: Drive ready | | <input type="radio"/> | <input type="radio"/> | <input type="radio"/> | <input type="radio"/> | <input type="radio"/> | <input type="radio"/> |
| 10: User-defined Low-voltage Detection (LV) | | <input type="radio"/> | <input type="radio"/> | <input type="radio"/> | <input type="radio"/> | <input type="radio"/> | <input type="radio"/> |
| 11: Malfunction indication | | <input type="radio"/> | <input type="radio"/> | <input type="radio"/> | <input type="radio"/> | <input type="radio"/> | <input type="radio"/> |
| 12: Mechanical brake release (Pr.02-29, Pr.02-30) | | <input type="radio"/> | <input type="radio"/> | <input type="radio"/> | <input type="radio"/> | <input type="radio"/> | <input type="radio"/> |
| 13: Overheat (Pr.06-14) | | <input type="radio"/> | <input type="radio"/> | <input type="radio"/> | <input type="radio"/> | <input type="radio"/> | <input type="radio"/> |
| 14: Brake chopper signal | | <input type="radio"/> | <input type="radio"/> | <input type="radio"/> | <input type="radio"/> | <input type="radio"/> | <input type="radio"/> |
| 15: Motor-controlled magnetic contactor output | | <input type="radio"/> | <input type="radio"/> | <input type="radio"/> | <input type="radio"/> | <input type="radio"/> | <input type="radio"/> |
| 16: Slip error (oSL) | | <input type="radio"/> | <input type="radio"/> | <input type="radio"/> | <input type="radio"/> | <input type="radio"/> | <input type="radio"/> |
| 17: Malfunction indication 1 | | <input type="radio"/> | <input type="radio"/> | <input type="radio"/> | <input type="radio"/> | <input type="radio"/> | <input type="radio"/> |
| 18: Reserved | | | | | | | |
| 19: Brake chopper output error | | <input type="radio"/> | <input type="radio"/> | <input type="radio"/> | <input type="radio"/> | <input type="radio"/> | <input type="radio"/> |
| 20: Warning output | | <input type="radio"/> | <input type="radio"/> | <input type="radio"/> | <input type="radio"/> | <input type="radio"/> | <input type="radio"/> |
| 21: Over voltage warning | | <input type="radio"/> | <input type="radio"/> | <input type="radio"/> | <input type="radio"/> | <input type="radio"/> | <input type="radio"/> |
| 22: Over-current stall prevention warning | | <input type="radio"/> | <input type="radio"/> | <input type="radio"/> | <input type="radio"/> | <input type="radio"/> | <input type="radio"/> |
| 23: Over-voltage stall prevention warning | | <input type="radio"/> | <input type="radio"/> | <input type="radio"/> | <input type="radio"/> | <input type="radio"/> | <input type="radio"/> |
| 24: Operation mode indication (Pr.00-15≠0) | | <input type="radio"/> | <input type="radio"/> | <input type="radio"/> | <input type="radio"/> | <input type="radio"/> | <input type="radio"/> |

| | | | | | | |
|------------------------------------------------------|-----------------------|-----------------------|-----------------------|-----------------------|-----------------------|-----------------------|
| 25: Forward command | <input type="radio"/> | <input type="radio"/> | <input type="radio"/> | <input type="radio"/> | <input type="radio"/> | <input type="radio"/> |
| 26: Reverse command | <input type="radio"/> | <input type="radio"/> | <input type="radio"/> | <input type="radio"/> | <input type="radio"/> | <input type="radio"/> |
| 27: Output when current \geq Pr.02-33 | <input type="radio"/> | <input type="radio"/> | <input type="radio"/> | <input type="radio"/> | <input type="radio"/> | <input type="radio"/> |
| 28: Output when current $<$ Pr.02-33 | <input type="radio"/> | <input type="radio"/> | <input type="radio"/> | <input type="radio"/> | <input type="radio"/> | <input type="radio"/> |
| 29: Output when frequency \geq Pr.02-34 | <input type="radio"/> | <input type="radio"/> | <input type="radio"/> | <input type="radio"/> | <input type="radio"/> | <input type="radio"/> |
| 30: Output when frequency $<$ Pr.02-34 | <input type="radio"/> | <input type="radio"/> | <input type="radio"/> | <input type="radio"/> | <input type="radio"/> | <input type="radio"/> |
| 31: Power generation direction and status verify | <input type="radio"/> | <input type="radio"/> | <input type="radio"/> | <input type="radio"/> | <input type="radio"/> | <input type="radio"/> |
| 32: Power generation direction | <input type="radio"/> | <input type="radio"/> | <input type="radio"/> | <input type="radio"/> | <input type="radio"/> | <input type="radio"/> |
| 33: Zero speed (actual output frequency) | <input type="radio"/> | <input type="radio"/> | <input type="radio"/> | <input type="radio"/> | | <input type="radio"/> |
| 34: Zero speed with Stop (actual output frequency) | <input type="radio"/> | <input type="radio"/> | <input type="radio"/> | <input type="radio"/> | | <input type="radio"/> |
| 35: Fault output option 1 (Pr.06-22) | <input type="radio"/> | <input type="radio"/> | <input type="radio"/> | <input type="radio"/> | <input type="radio"/> | <input type="radio"/> |
| 36: Fault output option 2 (Pr.06-23) | <input type="radio"/> | <input type="radio"/> | <input type="radio"/> | <input type="radio"/> | <input type="radio"/> | <input type="radio"/> |
| 37: Fault output option 3 (Pr.06-24) | <input type="radio"/> | <input type="radio"/> | <input type="radio"/> | <input type="radio"/> | <input type="radio"/> | <input type="radio"/> |
| 38: Fault output option 4 (Pr.06-25) | <input type="radio"/> | <input type="radio"/> | <input type="radio"/> | <input type="radio"/> | <input type="radio"/> | <input type="radio"/> |
| 39: Reserved | | | | | | |
| 40: Speed attained (including zero speed) | <input type="radio"/> | <input type="radio"/> | <input type="radio"/> | <input type="radio"/> | | <input type="radio"/> |
| 41: Reserved | | | | | | |
| 42: STO Output Error | | | | | | |
| 43~44: Direct Docking Mode only \blacklozenge | | | | | | |
| 45: Reserved | | | | | | |
| 46: Indicator of Retrying while a fault has occurred | | | | | | |
| 47: Direct Docking Mode only \blacklozenge | | | | | | |

| Settings | Functions | Descriptions |
|----------|------------------------------------------------|----------------------------------------------------------------------|
| 0 | No Function | No function |
| 1 | AC Drive Operational | Active when there is an output from the drive or RUN command is ON. |
| 2 | Operation speed attained | Active when the AC motor drive reaches the output frequency setting. |
| 3 | Desired Frequency Attained 1 (Pr.02-25, 02-26) | Active when the desired frequency (Pr.02-25, 02-26) is attained. |
| 4 | Desired Frequency Attained 2 (Pr.02-27, 02-28) | Active when the desired frequency (Pr.02-27, 02-28) is attained. |
| 5 | Zero Speed (frequency command) | Active when frequency command =0. (the drive should be at RUN mode) |
| 6 | Zero Speed with Stop (frequency command) | Active when frequency command =0 or stop. |

| | | |
|---|------------------------------------|---------------------------------------------------------------------------------------------------------------------------------------------------------------------------------------|
| 7 | Over Torque (OT1) (Pr.06-05~06-07) | Active when detecting over-torque. Refer to Pr.06-05 (over-torque detection selection-OT1), Pr.06-06 (over-torque detection level-OT1) and Pr.06-07 (over-torque detection time-OT1). |
|---|------------------------------------|---------------------------------------------------------------------------------------------------------------------------------------------------------------------------------------|

| | | |
|----|--------------------------------------------------|---------------------------------------------------------------------------------------------------------------------------------------------------------------------------------------|
| 8 | Over Torque (OT2) (Pr.06-08~06-10) | Active when detecting over-torque. Refer to Pr.06-08 (over-torque detection selection-OT2), Pr.06-09 (over-torque detection level-OT2) and Pr.06-10 (over-torque detection time-OT2). |
| 9 | Drive Ready | Active when the drive is ON and no abnormality detected. |
| 10 | User-defined Low-voltage Detection | Active when the DC Bus voltage is too low. (refer to Pr.06-00 low voltage level) |
| 11 | Malfunction Indication | Active when fault occurs (except Lv stop). |
| 12 | Mechanical Brake Release (Pr.02-29, Pr.02-30) | When drive runs after Pr.02-29, it will be ON. This function should be used with DC brake and it is recommended to use contact "b" (N.C). |
| 13 | Overheat (Pr.06-14) | Active when IGBT or heat sink overheats to prevent OH turn off the drive. (refer to Pr.06-14) |
| 14 | Brake Chopper Signal | The output will be activated when the drive needs help braking the load. A smooth deceleration is achieved by using this function. (refer to Pr.07-00) |
| 15 | Motor-controlled Magnetic Contactor Output | Active when the setting is set to 15. |
| 16 | Slip Error (oS _L) | Active when the slip error is detected (by Pr.05-14). |
| 17 | Malfunction indication 1 | Activate after 10ms when fault occurs (except Lv stop). |
| 18 | Reserved | |
| 19 | Brake Chopper Output Error | Active when the brake chopper error is detected |
| 20 | Warning Output | Active when the warning is detected. |
| 21 | Over-voltage Warning | Active when the over-voltage is detected. |
| 22 | Over-current Stall Prevention Warning | Active when the over-current stall prevention is detected. |
| 23 | Over-voltage Stall prevention Warning | Active when the over-voltage stall prevention is detected. |
| 24 | Operation Mode Indication | Active when the operation command is controlled by external terminal. (Pr.00-15=1) and PU LED on keypad KPVL-CC01 is OFF. |
| 25 | Forward Command | Active when the operation direction is forward. |
| 26 | Reverse Command | Active when the operation direction is reverse. |
| 27 | Output when Current \geq Pr.02-33 | Active when current is \geq Pr.02-33. |
| 28 | Output when Current $<$ Pr.02-33 | Active when current is $<$ Pr.02-33. |
| 29 | Output when frequency \geq Pr.02-34 | Active when frequency is \geq Pr.02-34. |
| 30 | Output when Frequency $<$ Pr.02-34 | Active when frequency is $<$ Pr.02-34. |
| 31 | Power Generation Direction and Status Verify | Activate when power generation direction is verified. |

| | | | | | | | | | | | | | |
|-------|--------------------------------------------------|-----------------------------------------------------------------------------------------------------------------------------------------------------------------------------------------------------------------------------------------------------------------------------------------------------------------------------------------------------------------------------------------------------------|----------------------|-------------------------|----------------------------------------------|----------------------------------------------|--------|----------------------|-----|----------------------|--|-----------|----------------------|
| 32 | Power Generation Direction | Activate when power generation direction is forward run. | | | | | | | | | | | |
| 33 | Zero Speed (actual output frequency) | Active when the actual output frequency is 0. (the drive should be at RUN mode) | | | | | | | | | | | |
| 34 | Zero Speed with Stop (actual output frequency) | Active when the actual output frequency is 0 or Stop. (the drive should be at RUN mode) | | | | | | | | | | | |
| 35 | Fault output option 1 | Active when Pr.06-22 is ON. | | | | | | | | | | | |
| 36 | Fault output option 2 | Active when Pr.06-23 is ON. | | | | | | | | | | | |
| 37 | Fault output option 3 | Active when Pr.06-24 is ON. | | | | | | | | | | | |
| 38 | Fault output option 4 | Active when Pr.06-25 is ON. | | | | | | | | | | | |
| 39 | Reserved | | | | | | | | | | | | |
| 40 | Speed Attained (including zero speed) | Active when the output frequency reaches frequency setting. | | | | | | | | | | | |
| 41 | Reserved | | | | | | | | | | | | |
| 42 | STO Output Error | <table border="1"> <tr> <td rowspan="2">Status of Drive</td> <td>Status of Safety Output</td> <td rowspan="4">Setting of Logic Output B is on page 16-6</td> </tr> <tr> <td>Status A (MO=42)</td> </tr> <tr> <td>Normal</td> <td>Broken Circuit(Open)</td> </tr> <tr> <td>STO</td> <td>Short Circuit(Close)</td> </tr> <tr> <td></td> <td>STL1~STL3</td> <td>Short Circuit(Close)</td> </tr> </table> | Status of Drive | Status of Safety Output | Setting of Logic Output B is on page 16-6 | Status A (MO=42) | Normal | Broken Circuit(Open) | STO | Short Circuit(Close) | | STL1~STL3 | Short Circuit(Close) |
| | | Status of Drive | | Status of Safety Output | | Setting of Logic Output B is on page 16-6 | | | | | | | |
| | | | Status A (MO=42) | | | | | | | | | | |
| | | Normal | Broken Circuit(Open) | | | | | | | | | | |
| STO | Short Circuit(Close) | | | | | | | | | | | | |
| | STL1~STL3 | Short Circuit(Close) | | | | | | | | | | | |
| 43~44 | Direct Docking Mode only ◆ | Contact Delta for more information | | | | | | | | | | | |
| 45 | Reserved | | | | | | | | | | | | |
| 46 | Indicator of Retrying while a fault has occurred | Re-attempt to do multiple output while an error has occurred. When finish re-attempting, MO will stop. | | | | | | | | | | | |
| 47 | Direct Docking Mode only ◆` | Contact Delta for more information | | | | | | | | | | | |

02-23 Multi-output Direction

Control Mode **VF VFPG SVC FOCPG TQCPG FOCPM** Factory Setting: 0
 Settings 0~65535

This parameter is bit setting. If the bit is 1, the multi-function output terminal will be act with opposite direction. For example, if Pr.02-11 is set to 1 and forward bit is 0, Relay 1 will be ON when the drive is running and OFF when the drive is stop.

| | | | | | | | | | | | |
|--------|--------|-------|-------|-------|-------|-------|-------|--------------|--------------|--------------|--------------|
| Bit 11 | Bit 10 | Bit 9 | Bit 8 | Bit 7 | Bit 6 | Bit 5 | Bit 4 | Bit 3 | Bit 2 | Bit 1 | Bit 0 |
| - | - | - | - | - | - | MO2 | MO1 | R2A | R1A | MRA | RA |

02-24 Serial Start Signal Selection

Control Mode **VF VFPG SVC FOCPG FOCPM** Factory Setting: 0
 Settings 0: By FWD/REV signal
 1: By Enable signal

- This parameter is used to select serial start method of electromagnetic valve.
- When choose 0: by FWD/REV signal, the motor will start to run after the signal of enabling MI=40 is ON.
- When choose 1: by Enable signal, the electromagnetic valve, mechanical brake and DC brake will follow parameters' setting to run after FWD/REV and Enable are ON.

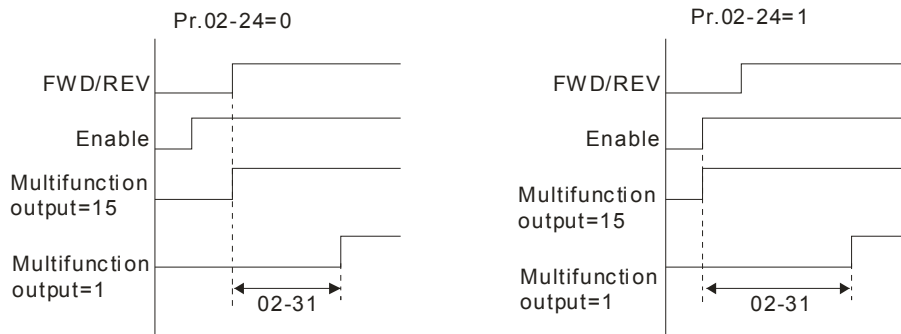
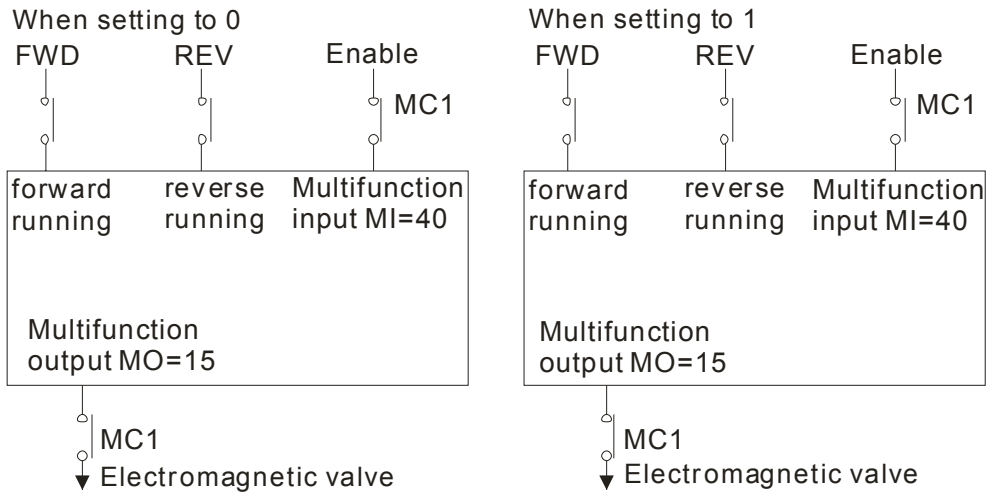

02-25 Desired Frequency Attained 1

Control Mode **VF VFPG SVC FOCPG FOCPM** Factory
 Setting:60.00/50.00
 Settings 0.00~400.00Hz

02-26 The Width of the Desired Frequency Attained 1

Control Mode **VF VFPG SVC FOCPG FOCPM** Factory Setting:2.00
 Settings 0.00~400.00Hz

02-27 Desired Frequency Attained 2

Control Mode **VF VFPG SVC FOCPG FOCPM** Factory
 Setting:60.00/50.00
 Settings 0.00~400.00Hz

02-28 The Width of the Desired Frequency Attained 2

Control Mode **VF VFPG SVC FOCPG FOCPM** Factory Setting:2.00
 Settings 0.00~400.00Hz

Once the output frequency reaches desired frequency and the corresponding multi-function output terminal is set to 3 or 4 (Pr.02-11~Pr.02-22), this multi-function output terminal will be ON.

02-29 Brake Release Delay Time when Elevator Starts

Control Mode **VF VFPG SVC FOCPG TQCPG FOCPM** Factory Setting:0.250
 Settings 0.000~65.000sec

02-30 Brake Engage Delay Time when Elevator Stops

Control Mode **VF VFPG SVC FOCPG TQCPG FOCPM** Factory Setting:0.250
 Settings 0.000~65.000sec

When the AC motor drive runs after the delay time set at Pr02-29, the corresponding multi-function output

terminal (12: mechanical brake release) will be ON.

When the AC motor drive stops and after Pr.02-30 delay time, the corresponding multi-function output terminal (12: mechanical brake release) will be OFF.

This function needs to co-work with DC brake function.

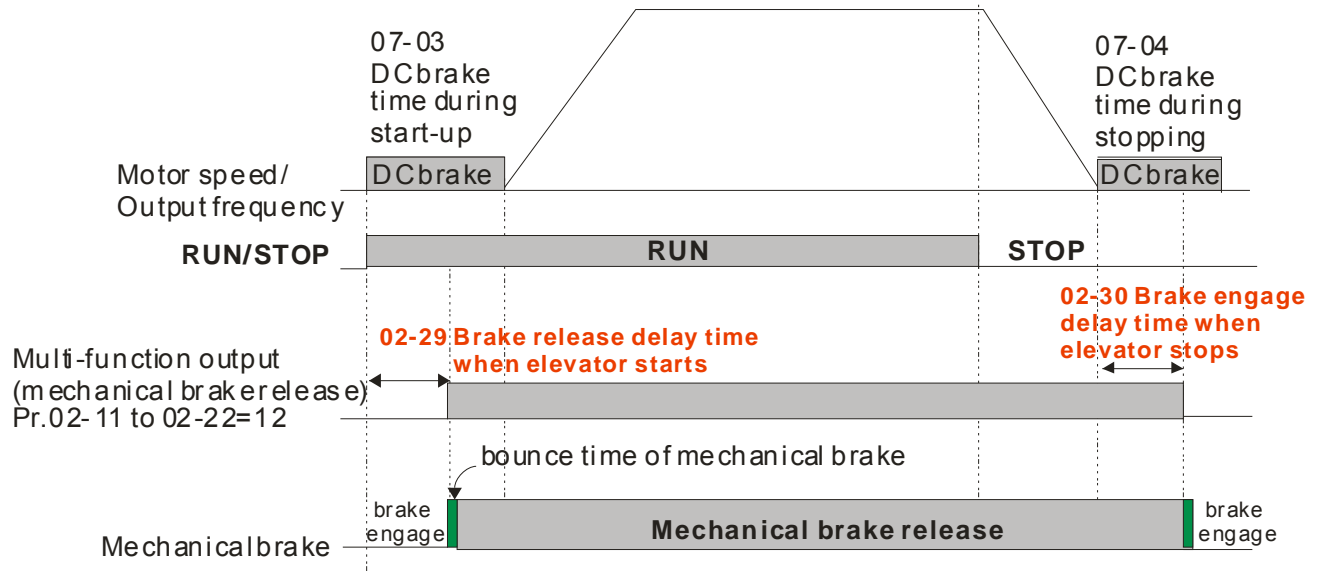

➤ **02-31** Turn On Delay of Magnetic Contact between Drive and Motor

➤ **02-32** Turn Off Delay of Magnetic Contact between Drive and Motor

Control Mode **VF** **VFP** **SVC** **FOCP** **TQCP** **FOCP** Factory Setting:0.20
 Settings 0.010~65.000 sec.

After running, it is used with setting 40 of multifunction input terminal and settings 15 of multifunction output terminals. When multifunction output terminals is ON, the drive starts output after Pr.02-31 delay time. When drive stops output, multifunction output terminals will release after Pr.02-32 delay time.

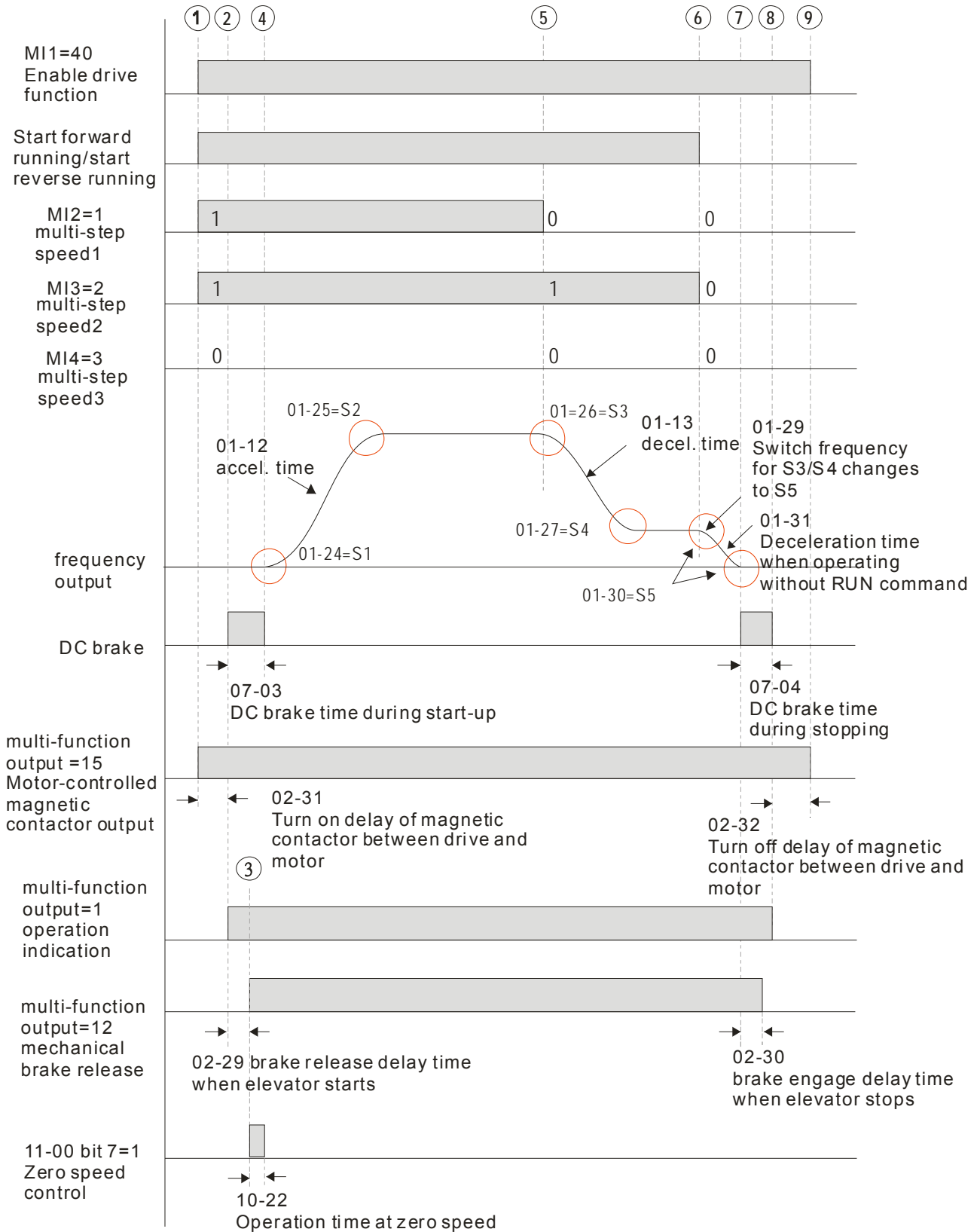

- ① elevator starts running ⑤ start deceleration ⑨ motor release
- ② electromagnetic valve is ON ⑥ the end of creep
- ③ brake release ⑦ start DC brake time during stopping
- ④ the end of DC brake time at start-up ⑧ the end of DC brake time during stopping

02-33 Output Current Level Setting for External Terminals
 Control Mode **VF VFPG SVC FOC PG TQCPG FOC PM** Factory Setting: 0
 Settings 0~100%

- When output current is \geq Pr.02-33, it will activate multi-function output terminal (Pr.02-11 to Pr.02-22 is set to 27).
- When output current is $<$ Pr.02-33, it will activate multi-function output terminal (Pr.02-11 to Pr.02-22 is set to 28).

02-34 Output Boundary for External Terminals
 Control Mode **VF VFPG SVC FOC PG TQCPG FOC PM** Factory Setting:0.00
 Settings 0.00~ \pm 400.00Hz

- When output frequency is \geq 02-34, it will activate the multi-function terminal (Pr.02-11 to Pr.02-22 is set to 29).
- When output frequency is $<$ 02-34, it will activate the multi-function terminal (Pr.02-11 to Pr.02-22 is set to 30).

02-35 Detection Time of Mechanical Brake
 Control Mode **VF VFPG SVC FOC PG TQCPG FOC PM** Factory Setting:0.00
 Settings 0.00~10.00sec

- When mechanical brake function (setting 42 of Pr.02-01~02-08) is not enabled within this setting time, it will display fault code 64 (MBF) mechanical brake error.

02-36 Detection Time of Magnetic Contactor
 Control Mode **VF VFPG SVC FOC PG TQCPG FOC PM** Factory Setting:0.00
 Settings 0.00~10.00sec

- When mechanical brake function (setting 41 of Pr.02-01~02-08) is not enabled within this setting time, it will display fault code 66 (MCF) mechanical brake error.

02-37 Check Torque Output Function
 Control Mode **VF VFPG SVC FOC PG TQCPG FOC PM** Factory Setting: 0
 Settings 0: Enable
 1: Disable

- When the drive receives the operation signal, the drive will check if there is torque output. When this function is enabled, it will release mechanical brake after confirming that there is torque output.

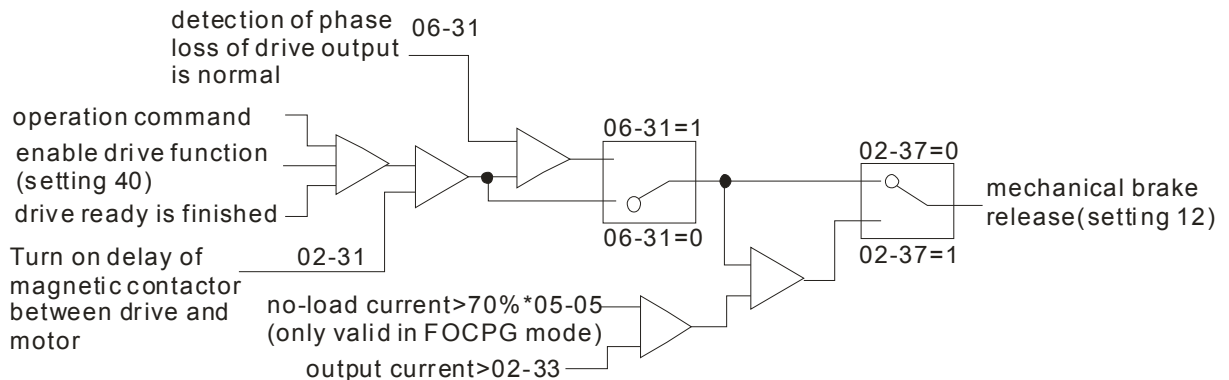

03 Analog Input/ Output Parameters

↗ **03-00** Analog Input 1 (AUI1) Factory Setting:1

↗ **03-01** Reserved

↗ **03-02** Analog Input 2 (AUI2) Factory Setting: 0

| Settings | Control Mode | VF | VFPG | SVC | FOCPG | TQCPG | FOCPM |
|------------------------------------------------------------|--------------|-----------------------|-----------------------|-----------------------|-----------------------|-----------------------|-----------------------|
| 0: No function | | <input type="radio"/> | <input type="radio"/> | <input type="radio"/> | <input type="radio"/> | <input type="radio"/> | <input type="radio"/> |
| 1: Frequency command (torque limit under TQR control mode) | | <input type="radio"/> | <input type="radio"/> | <input type="radio"/> | <input type="radio"/> | <input type="radio"/> | <input type="radio"/> |
| 2: Torque command (torque limit under speed mode) | | | | | | <input type="radio"/> | |
| 3: Preload input | | <input type="radio"/> | <input type="radio"/> | <input type="radio"/> | <input type="radio"/> | <input type="radio"/> | <input type="radio"/> |
| 4~5: Reserved | | | | | | | |
| 6: P.T.C. thermistor input value | | <input type="radio"/> | <input type="radio"/> | <input type="radio"/> | <input type="radio"/> | <input type="radio"/> | <input type="radio"/> |
| 7: Positive torque limit | | | | | <input type="radio"/> | | <input type="radio"/> |
| 8: Negative torque limit | | | | | <input type="radio"/> | | <input type="radio"/> |
| 9: Regenerative torque limit | | | | | <input type="radio"/> | | <input type="radio"/> |
| 10: Positive/negative torque limit | | | | | <input type="radio"/> | | <input type="radio"/> |

- When it is frequency command or TQR speed limit, the corresponding value for 0~±10V/4~20mA is 0 – max. output frequency(Pr.01-00)
- When it is torque command or torque limit, the corresponding value for 0~±10V/4~20mA is 0 – max. output torque (Pr.07-14).
- When it is torque compensation, the corresponding value for 0~±10V/4~20mA is 0 – rated torque.

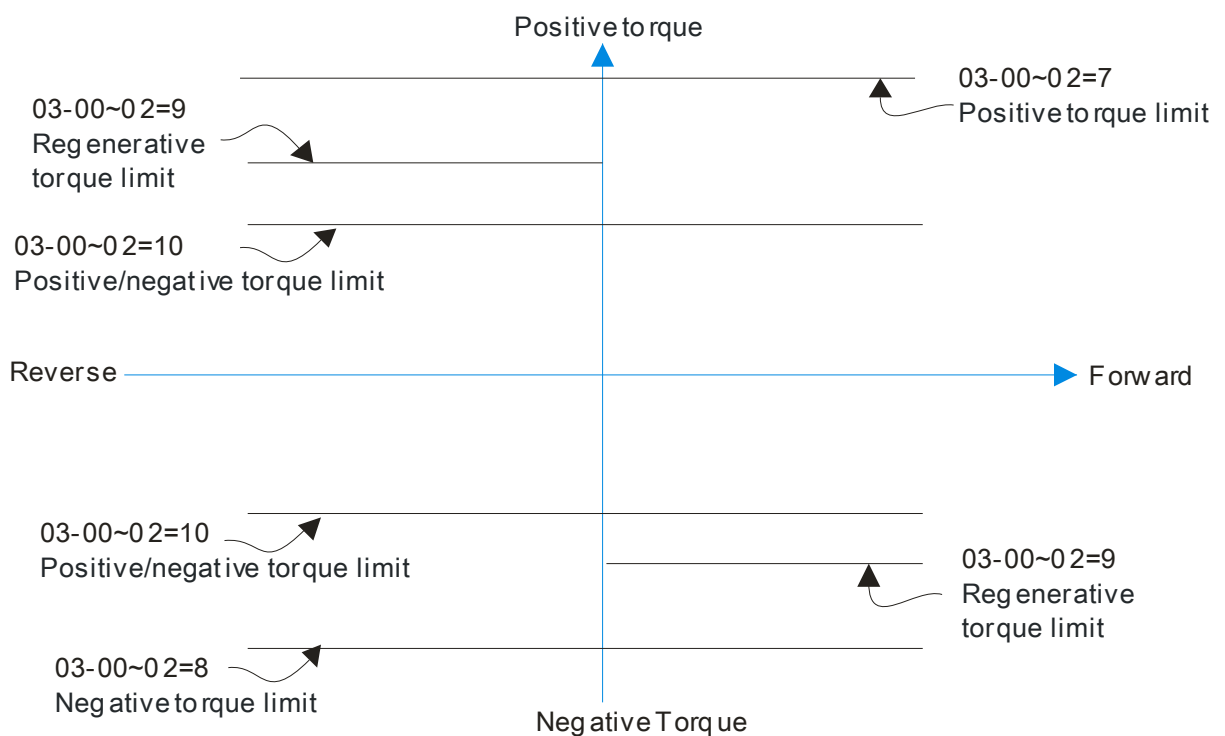

07-19: Source of torque offset
 03-00~02: Analog input selections (AUI1/ACI/AUI2)
 03-03~05: Analog input bias (AUI1/ACI/AUI2)
 03-06~08: AUI1/ACI/AUI2 bias mode

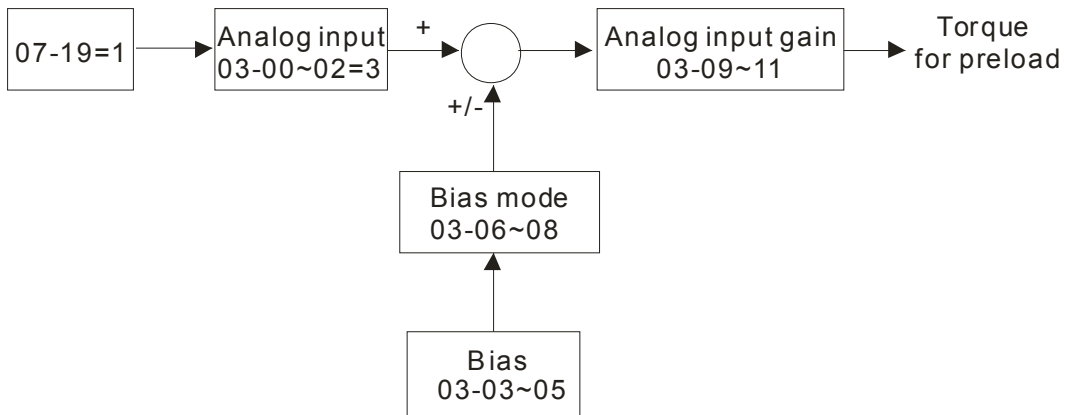

⚡ **03-03** Analog Input Bias 1 (AUI1)

Control Mode **VF** **VFPG** **SVC** **FOCPG** **TQCPG** **FOCPM** Factory Setting:0.0

Settings -100.0~100.0%

📖 It is used to set the corresponding AUI1 voltage of the external analog input 0.

03-04 Reserved

⚡ **03-05** Analog Input Bias 1 (AUI2)

Control Mode **VF** **VFPG** **SVC** **FOCPG** **TQCPG** **FOCPM** Factory Setting:0.0

Settings -100.0~100.0%

📖 It is used to set the corresponding AUI2 voltage of the external analog input 0.

📖 The relation between external input voltage/current and setting frequency is equal to -10~+10V (4-20mA) corresponds to 0-60Hz.

⚡ **03-06** AUI1 Positive/negative Bias Mode (AUI1)

Control Mode **VF** **VFPG** **SVC** **FOCPG** **TQCPG** **FOCPM** Factory Setting: 0

03-07 Reserved

⚡ **03-08** Positive/negative Bias Mode (AUI2)

Control Mode **VF** **VFPG** **SVC** **FOCPG** **TQCPG** **FOCPM** Factory Setting: 0

Settings 0: Zero bias

1: Serve bias as the center, lower than bias=bias

2: Serve bias as the center, greater than bias=bias

3: The absolute value of the bias voltage while serving as the center (unipolar)

4: Serve bias as the center (unipolar)

📖 In a noisy environment, it is advantageous to use negative bias to provide a noise margin. It is recommended NOT to use less than 1V to set the operating frequency.

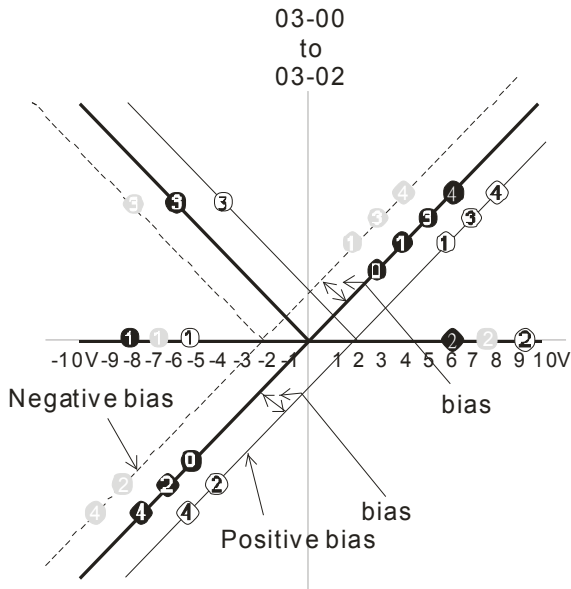

03-09~03-11 gain is positive

- 0 Zero bias
- 1 Serve bias as the center, lower than bias = bias
- 2 Serve bias as the center, greater than bias = bias
- 3 The absolute value of the bias voltage while serving as the center (unipolar)
- 4 Serve bias as the center (unipolar)

✦ **03-09** Analog Input Gain 1 (AUI1)
 Control Mode **VF VFBG SVC FOC PG TQCPG FOC PM** Factory Setting:100.0
 Settings 0.0~500.0%

03-10 Reserved

✦ **03-11** Analog Input Gain 1 (AUI2)
 Control Mode **VF VFBG SVC FOC PG TQCPG FOC PM** Factory Setting:100.0
 Settings 0.0~500.0%

📖 Parameters 03-03 to 03-11 are used when the source of frequency command is the analog voltage/current signal.

✦ **03-12** Analog Input Delay Time (AUI1)
 Control Mode **VF VFBG SVC FOC PG TQCPG FOC PM** Factory Setting:0.01
 Settings 0.00~2.00sec

03-13 Reserved

✦ **03-14** analog Input Delay Time (AUI2)
 Control Mode **VF VFBG SVC FOC PG TQCPG FOC PM** Factory Setting:0.01
 Settings 0.00~2.00sec

📖 Interferences commonly exist with analog signals, such as those entering AUI, ACI and AUI2. These interferences constantly affect the stability of analog control and using the Input Noise Filter will create a more stable system.

📖 If Pr03-14 is large, the control will be stable, yet the response to the input will be slow. If Pr. 03-14 is small, the control may be unstable, yet the response to the input will fast.

03-15 Reserved

03-16 Reserved

↗ **03-17** Analog Output Selection 1

↗ **03-20** Analog Output Selection 2

Control Mode **VF** **VFP** **SVC** **FOCPG** **TQCPG** **FOCPM** Factory Setting: 0

- Settings
- 0: Output frequency (Hz)
 - 1: Frequency command (Hz)
 - 2: Motor speed (RPM)
 - 3: Output current (rms)
 - 4: Output voltage
 - 5: DC Bus Voltage
 - 6: Power factor angle
 - 7: Power factor
 - 8: Output torque
 - 9 : AUI1
 - 10: Reserved
 - 11: AUI2
 - 12: q-axis current
 - 13: q-axis feedback value
 - 14: d-axis voltage
 - 15: d-axis feedback value
 - 16: q-axis voltage
 - 17: d-axis voltage
 - 18: Torque command
 - 19~20: Reserved
 - 21: Power output
-

↗ **03-18** Analog Output Gain 1

↗ **03-21** Analog Output Gain 2

Control Mode **VF** **VFP** **SVC** **FOCPG** **TQCPG** **FOCPM** Factory Setting: 100.0

Settings 0~200.0%

 This parameter is set the corresponding voltage of the analog output 0.

↗ **03-19** Analog Output Value in REV Direction 1

↗ **03-22** Analog Output Value in REV Direction 2

Control Mode **VF** **VFP** **SVC** **FOCPG** **TQCPG** **FOCPM** Factory Setting: 0

- Settings
- 0: Absolute value in REV direction
 - 1: Output 0V in REV direction
 - 2: Enable output voltage in REV direction
-

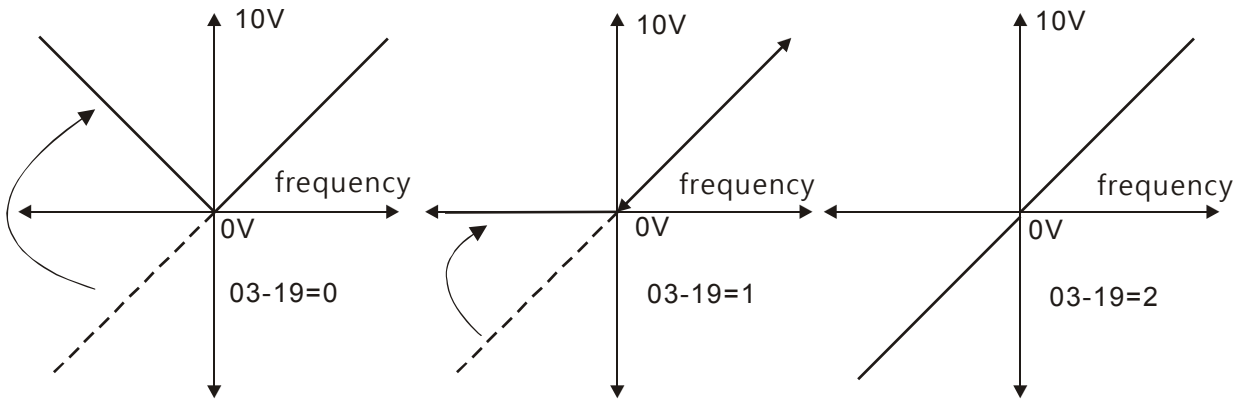

Selection for the analog output direction

03-23 Analog Input Type (AUI1)

03-24 Analog Input Type (AUI2)

Control Mode **VF VFBG SVC FOC PG TQCPG FOC PM** Factory Setting: 0

Settings 0: Bipolar ($\pm 10V$)

1: Unipolar (0~10V)

- When setting to 0 and Pr.03-00=1 or 2, AUI can decide the operation direction.
- When setting to 1 and Pr.03-00=1, the operation direction can be set by FWD/REV terminal.
- When setting to 1 and Pr.03-00=2, the operation direction can be set by setting 39 of Pr.02-01 to Pr.02-08.

04 Multi-Step Speed Parameters

- ↘ **04-00** Zero Step Speed Frequency
- ↘ **04-01** 1st Step Speed Frequency
- ↘ **04-02** 2nd Step Speed Frequency
- ↘ **04-03** 3rd Step Speed Frequency
- ↘ **04-04** 4th Step Speed Frequency
- ↘ **04-05** 5th Step Speed Frequency
- ↘ **04-06** 6th Step Speed Frequency
- ↘ **04-07** 7th Step Speed Frequency
- ↘ **04-08** 8th Step Speed Frequency
- ↘ **04-09** 9th Step Speed Frequency
- ↘ **04-10** 10th Step Speed Frequency
- ↘ **04-11** 11th Step Speed Frequency
- ↘ **04-12** 12th Step Speed Frequency
- ↘ **04-13** 13th Step Speed Frequency
- ↘ **04-14** 14th Step Speed Frequency

Control Mode **VF** **VFPG** **SVC** **FOCPG** **FOCPM** Factory Setting:0.00
 Settings 0.00~120.00Hz

- ↘ **04-15** 15th Step Speed Frequency

Control Mode **VF** **VFPG** **SVC** **FOCPG** **FOCPM** Factory Setting:0.00
 Settings 0.00~400.00Hz

 The Multi-Function Input Terminals (refer to Pr.02-01 to 02-08) are used to select one of the AC motor drive Multi-step speeds (including the main speed, in total 16 speeds). The speeds (frequencies) are determined by Pr.04-00 to 04-15 as shown above.

04-16 Direct docking mode only

~
04-99

Control Mode **VF** **VFPG** **SVC** **FOCPG** **FOCPM** Factory Setting:
 Settings Contact Delta for more information

05 IM Parameters

05-00 Motor Auto Tuning

Control Mode **VF**

Factory Setting: 0

- Settings
- 0: No function
 - 1: Rolling test (Rs, Rr, Lm, Lx, no-load current)
 - 2: Static Test

📖 Starting auto tuning by pressing RUN key and it will write the measure value into Pr.05-05 to Pr.05-09 (Rs, Rr, Lm, Lx, no-load current).

📖 The steps to AUTO-Tuning are: (when setting to 1)

1. Make sure that all the parameters are set to factory settings and the motor wiring is correct.
2. Make sure the motor has no-load before executing auto-tuning and the shaft is not connected to any belt or gear motor. It is recommended to set to 2 if the motor can't separate from the load.
3. Fill in Pr.01-02, Pr.01-01, Pr.05-01, Pr.05-02, Pr.05-03 and Pr.05-04 with correct values. Refer to motor capacity to set accel./decel. time.
4. When Pr.05-00 is set to 1, the AC motor drive will execute auto-tuning immediately after receiving a "RUN" command. (NOTE: the motor will run!)
5. After executing, please check if all values are filled in Pr.05-05 to Pr.05-09.
6. Equivalent circuit

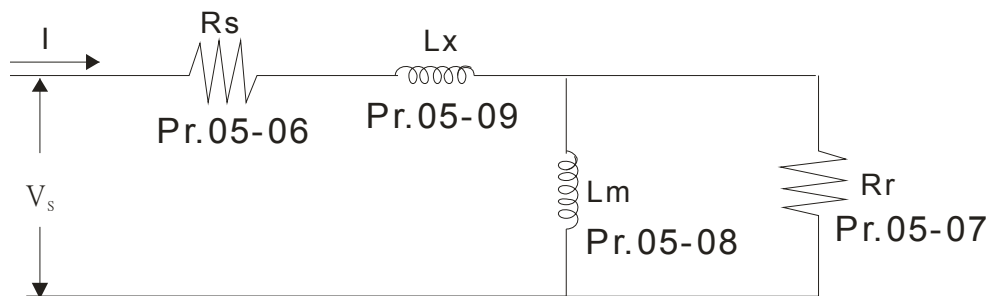

Equivalent circuit for VFD-ED Series

※ If Pr05-00 is set to <2: Static Test>, the input of Pr05-05 is required.

NOTE

1. In torque/vector control mode, it is not recommended to have motors run in parallel.
2. It is not recommended to use torque/vector control mode if motor rated power exceeds the rated power of the AC motor drive.
3. The no-load current is usually 20~50% X rated current.
4. The rated speed can't be larger or equal to $120f/p$. (f: output frequency Pr.01-01, p: Number of Motor Poles Pr.05-04)
5. After the tuning, user needs to activate the drive again to make it operate if the source command of Auto-tuning comes from external terminal,

05-01 Full-load Current of MotorControl Mode **VF VFPG SVC FOC PG TQCPG**

Unit: Amp

Factory Setting:###

Settings (40~120%) *00-01 Amps

- This value should be set according to the rated frequency of the motor as indicated on the motor nameplate. The factory setting is 90% X rated current.
Example: if the rated current for 7.5hp (5.5kW) models is 25A and the factory setting is 22.5A. In this way, the current range will be from 10A (25*40%) to 30A (25*120%).
- As shown in the table below, the factory settings vary according to the different output in HP and in KW of motor drives.

| | Motor drive's output (HP) | 5 | 7.5 | 10 | 15 | 20 | 25 | 30 | 40 | 50 | 60 | 75 | 100 |
|------|---------------------------------------------------|--------|-------|-------|-------|-------|------|-------|-------|--------|----|----|-----|
| | Motor drive's output (KW) | 4 | 5.5 | 7.5 | 11 | 15 | 18.5 | 22 | 30 | 37 | 45 | 55 | 75 |
| 230V | Full Load Current of Motor (A) Factory Setting | 16..36 | 19.64 | 24.54 | 36.82 | 47.46 | 63 | 71.18 | 108 | 131.72 | / | | |
| 460V | Full Load Current of Motor(A) Factory Setting | 9.41 | 10.64 | 13.91 | 18.82 | 24.54 | 31.1 | 36.82 | 47.46 | 65.46 | | | |

05-02 Rated Power of MotorControl Mode **SVC FOC PG TQCPG**

Factory Setting: ###

Settings 0.00~655.35 kW

- It is used to set rated power of the motor. The factory setting is the power of the drive.

05-03 Rated Speed of Motor (rpm)Control Mode **VFPG SVC FOC PG TQCPG**

Factory Setting:1710

Settings 0~65535

- It is used to set the rated speed of the motor and need to set according to the value indicated on the motor nameplate.

05-04 Number of Motor PolesControl Mode **VF VFPG SVC FOC PG TQCPG**

Factory Setting:4

Settings 2~48

- It is used to set the number of motor poles (must be an even number).

05-05 No-load Current of MotorControl Mode **VFPG SVC FOC PG TQCPG**

Unit: Amp

Factory Setting:###

Settings 0~100%

- The factory setting is 40% X rated current.
- As shown in the table below, the factory settings vary according to the different output in HP and in KW of motor drives.

| | | | | | | | | | | | | | |
|------|--------------------------------------------------|------|------|------|-------|-------|-------|-------|-------|-------|----|----|-----|
| | Motor drive's output (HP) | 5 | 7.5 | 10 | 15 | 20 | 25 | 30 | 40 | 50 | 60 | 75 | 100 |
| | Motor drive's output (KW) | 4 | 5.5 | 7.5 | 11 | 15 | 18.5 | 22 | 30 | 37 | 45 | 55 | 75 |
| 230V | Current of Motor w/o load (A) Factory Setting | 5.73 | 6.85 | 8.5 | 12.56 | 15.97 | 20.78 | 23.22 | 33.51 | 39.52 | | | |
| 460V | Current of Motor w/o load (A) Factory Setting | 3.29 | 3.71 | 4.81 | 6.43 | 8.26 | 10.28 | 11.99 | 15 | 19.64 | | | |

05-06 Rs of Motor

05-07 Rr of Motor

Control Mode **SVC FOC PG TQCPG** Factory Setting:0.000
Settings 0.000~65.535Ω

05-08 Lm of Motor

05-09 Lx of Motor

Control Mode **SVC FOC PG TQCPG** Factory Setting:0.0
Settings 0.0~6553.5mH

↗ **05-10** Torque Compensation Time Constant

Control Mode **SVC** Factory Setting:0.020
Settings 0.001~10.000sec

↗ **05-11** Slip Compensation Time Constant

Control Mode **SVC** Factory Setting:0.100
Settings 0.001~10.000sec

📖 Setting Pr.05-10 and Pr.05-11 change the response time for the compensation.

📖 When Pr.05-10 and Pr.05-11 are set to 10 seconds, its response time for the compensation will be the longest. But if the settings are too short, unstable system may occur.

↗ **05-12** Torque Compensation Gain

Control Mode **VF VFPG** Factory Setting: 0
Settings 0~10

📖 This parameter may be set so that the AC motor drive will increase its voltage output to obtain a higher torque.

↗ **05-13** Slip Compensation Gain

Control Mode **VF VFPG SVC** Factory Setting:0.00
Settings 0.00~10.00

📖 When the asynchronous motor is driven by the drive, the load and slip will be increased. This parameter can be used to correct frequency and lower the slip to make the motor can run near the synchronous speed under rated current. When the output current is larger than the motor no-load current, the drive will compensate the frequency by Pr.05-13 setting. If the actual speed is slower than expectation, please increase the setting and vice versa.

📖 It is only valid in SVC mode.

| | | | | | | | | | |
|---|--------------|----------------------|------------|--------------|--|--|--|--|--------------------|
| ↗ | 05-14 | Slip Deviation Level | | | | | | | |
| | Control Mode | VFPG | SVC | FOCPG | | | | | Factory Setting: 0 |
| | Settings | 0~1000% | | | | | | | |
| | | 0: Disable | | | | | | | |

| | | | | | | | | | |
|---|--------------|----------------------------------|------------|--------------|--|--|--|--|---------------------|
| ↗ | 05-15 | Detection time of Slip Deviation | | | | | | | |
| | Control Mode | VFPG | SVC | FOCPG | | | | | Factory Setting:1.0 |
| | Settings | 0.0~10.0sec | | | | | | | |

| | | | | | | | | | |
|---|--------------|----------------------------|------------|--------------|--|--|--|--|--------------------|
| ↗ | 05-16 | Over Slip Treatment | | | | | | | |
| | Control Mode | VFPG | SVC | FOCPG | | | | | Factory Setting: 0 |
| | Settings | 0: Warn and keep operation | | | | | | | |
| | | 1: Fault and ramp to stop | | | | | | | |
| | | 2: Fault and coast to stop | | | | | | | |

📖 Pr.05-14 to Pr.05-16 are used to set allowable slip level/time and over slip treatment when the drive is running.

| | | | | | | | | | |
|---|--------------|--------------|-------------|------------|--|--|--|--|----------------------|
| ↗ | 05-17 | Hunting Gain | | | | | | | |
| | Control Mode | VF | VFPG | SVC | | | | | Factory Setting:2000 |
| | Settings | 0~10000 | | | | | | | |
| | | 0: Disable | | | | | | | |

📖 The motor will have current wave motion in some specific area. It can improve this situation by setting this parameter. (When it is high frequency or run with PG, Pr.05-17 can be set to 0. when the current wave motion happens in the low frequency, please increase Pr.05-17.)

| | | | | | | | | | |
|--|--------------|------------------------------------------|-------------|------------|--------------|--------------|--------------|--|--------------------|
| | 05-18 | Accumulative Motor Operation Time (Min.) | | | | | | | |
| | Control Mode | VF | VFPG | SVC | FOCPG | TQCPG | FOCPM | | Factory Setting:00 |
| | Settings | 00~1439 minutes | | | | | | | |

| | | | | | | | | | |
|--|--------------|-----------------------------------------|-------------|------------|--------------|--------------|--------------|--|--------------------|
| | 05-19 | Accumulative Motor Operation Time (Day) | | | | | | | |
| | Control Mode | VF | VFPG | SVC | FOCPG | TQCPG | FOCPM | | Factory Setting:00 |
| | Settings | 00~65535 days | | | | | | | |

📖 Pr. 05-18 and Pr.05-19 are used to record the motor operation time. They can be cleared by setting to 00 and time which is less than 60 seconds will not be recorded.

| | | | | | | | | | |
|---|--------------|------------------------|--|--|--|--|--|--|--------------------|
| ↗ | 05-20 | Core Loss Compensation | | | | | | | |
| | Control Mode | SVC | | | | | | | Factory Setting:10 |
| | Settings | 0~250% | | | | | | | |

05-21 Accumulative Drive Power-on Time (Min.)

Control Mode **VF** **VFP** **SVC** **FOCPG** **TQCPG** **FOCPM** Factory Setting:00
 Settings 00~1439 minutes

05-22 Accumulative Drive Power-on Time (day)



Control Mode **VF** **VFP** **SVC** **FOCPG** **TQCPG** **FOCPM** Factory Setting:00
 Settings 00~65535 days

05-23 Slip compensation gain % (electricity generating mode)

Control Mode **VF** **SVC** Factory Setting: 0.0
 Settings 0.0~100.0%

05-24 Slip compensation gain % (electric mode)

Control Mode **VF** **SVC** Factory Setting: 0.0
 Settings 0.0~100.0%

-  When in VF mode, it is NOT required to set Pr05-13. To satisfy the end user's demand on different compensation gain of electricity generating mode and electric mode, simply set up Pr05-23 and Pr05-24.
-  When in SVC mode, it is required to set Pr05-13. Then to satisfy the end user's demand on different compensation gain of electricity generating mode and electric mode, simply set up Pr05-23 and Pr05-24.

06 Protection Parameters

06-00 Low Voltage Level

Control Mode **VF** **VFP** **SVC** **FOCP** **TQCP** **FOCP** Factory Setting:180.0/360.0
 Settings 230V series: 160.0~220.0V
 460V series: 320.0~440.0V

It is used to set the Lv level.

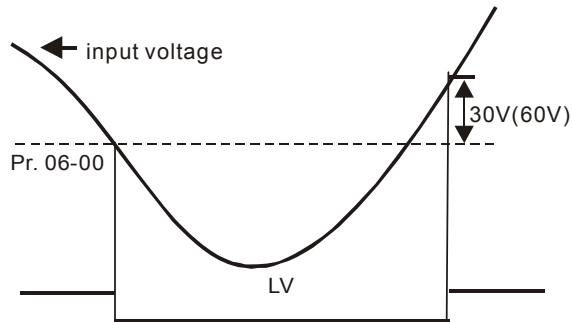

06-01 Phase-loss Protection

Control Mode **VF** **VFP** **SVC** **FOCP** **TQCP** **FOCP** Factory Setting:2
 Settings 0: Warn and keep operation
 1: Fault and ramp to stop
 2: Fault and coast to stop

It is used to set the phase-loss treatment. The phase-loss will effect driver's control characteristic and life

06-02 Over-Current Stall Prevention during Acceleration

Control Mode **VF** **VFP** **SVC** Factory Setting:00
 Settings 00: Disable
 00~250% (rated current of the motor drive)

During acceleration, the AC drive output current may increase abruptly and exceed the value specified by Pr.06-02 due to rapid acceleration or excessive load on the motor. When this function is enabled, the AC drive will stop accelerating and keep the output frequency constant until the current drops below the maximum value.

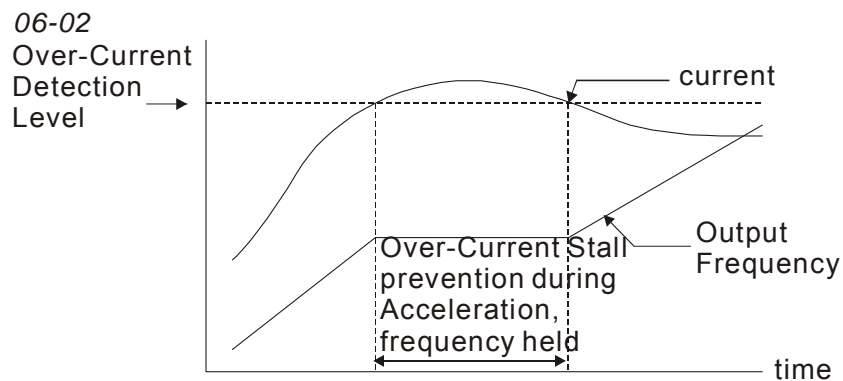

actual acceleration time when over-current stall prevention is enabled

06-03 Over-current Stall Prevention during Operation

Control Mode **VF** **VFPG** **SVC**

Factory Setting: 00

Settings 00: Disable

00~250% (rated current of the motor drive)

If the output current exceeds the setting specified in Pr.06-03 when the drive is operating, the drive will decrease its output frequency by Pr.06-04 setting to prevent the motor stall. If the output current is lower than the setting specified in Pr.06-03, the drive will accelerate (by Pr.06-04) again to catch up with the set frequency command value.

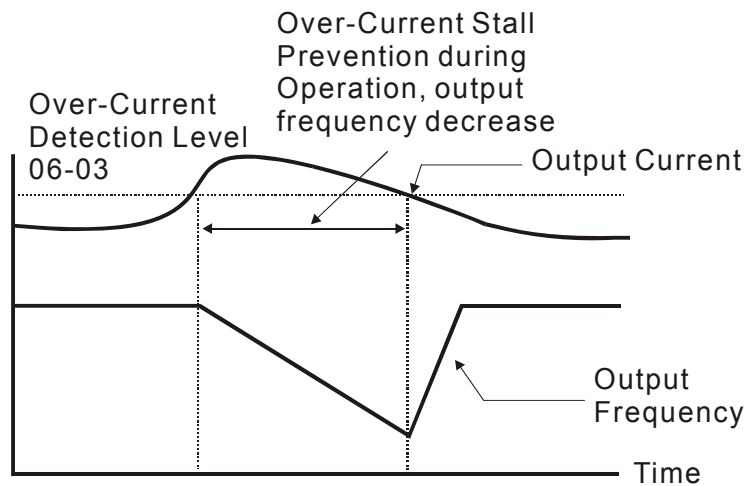

over-current stall prevention during operation

06-04 Accel. /Decel. Time Selection of Stall Prevention at constant speed

Control Mode **VF** **VFPG** **SVC**

Factory Setting: 0

Settings 0: current accel/decel time

1: the 1st accel/decel time

2: the 2nd accel/decel time

3: the 3rd accel/decel time

4: the 4th accel/decel time

5: auto accel/decel time

It is used to set the accel. /decel. time selection when stall prevention occurs at constant speed.

06-05 Over-torque Detection Selection (OT1)

Control Mode **VF** **VFPG** **SVC** **FOCPG** **TQCPG** **FOCPM**

Factory Setting: 0

Settings 0: Over-Torque detection disabled.

1: Over-torque detection during constant speed operation, continue to operate after detection

2: Over-torque detection during constant speed operation, stop operation after detection

3: Over-torque detection during operation, continue to operate after detection

4: Over-torque detection during operation, stop operation after detection

| | | | | | | | | |
|---|--------------|------------------------------------------------------------------------------------------------------------------------------------------------------------------------------------------------------------------------------------------------------------------------------------------------------------------------------------------------------------------------------------------------|-------------|------------|--------------|--------------|--------------|---------------------|
| ↗ | 06-06 | Over-torque Detection Level (OT1) | | | | | | |
| | Control Mode | VF | VFPG | SVC | FOCPG | TQCPG | FOCPM | Factory Setting:150 |
| | Settings | 10~250% (rated current of the motor drive) | | | | | | |
| ↗ | 06-07 | Over-torque Detection Time (OT1) | | | | | | Factory Setting:0.1 |
| | Control Mode | VF | VFPG | SVC | FOCPG | TQCPG | FOCPM | Factory Setting:0.1 |
| | Settings | 0.1~60.0sec | | | | | | |
| ↗ | 06-08 | Over-torque Detection Selection (OT2) | | | | | | Factory Setting: 0 |
| | Control Mode | VF | VFPG | SVC | FOCPG | TQCPG | FOCPM | Factory Setting: 0 |
| | Settings | 0: Over-Torque detection disabled. 1: Over-torque detection during constant speed operation, continue to operate after detection 2: Over-torque detection during constant speed operation, stop operation after detection 3: Over-torque detection during operation, continue to operate after detection 4: Over-torque detection during operation, stop operation after detection | | | | | | |
| ↗ | 06-09 | Over-torque Detection Level (OT2) | | | | | | Factory Setting:150 |
| | Control Mode | VF | VFPG | SVC | FOCPG | TQCPG | FOCPM | Factory Setting:150 |
| | Settings | 10~250% (rated current of the motor drive) | | | | | | |
| ↗ | 06-10 | Over-torque Detection Time (OT2) | | | | | | Factory Setting:0.1 |
| | Control Mode | VF | VFPG | SVC | FOCPG | TQCPG | FOCPM | Factory Setting:0.1 |
| | Settings | 0.1~60.0sec | | | | | | |

📖 Pr.06-05 and Pr.06-08 determine the operation mode of the drive after the over-torque is detected via the following method: if the output current exceeds the over-torque detection level (Pr.06-06) and also exceeds the Pr.06-07 Over-Torque Detection Time, the fault code “OT1/OT2” is displayed. If a Multi-Functional Output Terminal is to over-torque detection, the output is on. Please refer to Pr.02-11~02-22 for details.

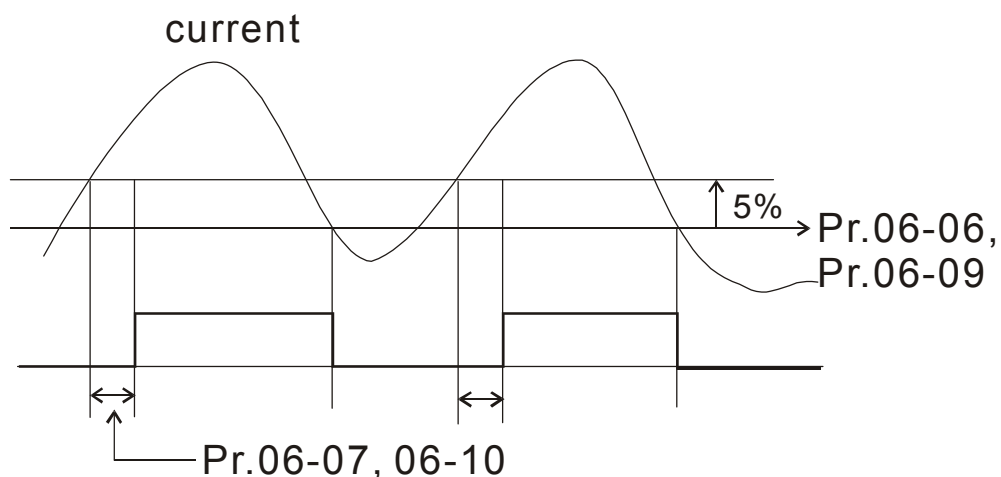

| | | | | | | | | |
|---|--------------|-------------------------------------------|--------------|--------------|--------------|--|--|---------------------|
| ↗ | 06-11 | Current Limit | | | | | | Factory Setting:200 |
| | Control Mode | | FOCPG | TQCPG | FOCPM | | | Factory Setting:200 |
| | Settings | 0~250% (rated current of the motor drive) | | | | | | |

📖 It is used to set the current limit.

06-12 Electronic Thermal Relay Selection

Control Mode **VF VFPG SVC FOC PG TQCPG FOC PM** Factory Setting:2

- Settings 0: Inverter motor
 1: Standard motor
 2: Disabled

It is used to prevent self-cooled motor overheats under low speed. User can use electrical thermal relay to limit driver's output power.

06-13 Electronic Thermal Characteristic

Control Mode **VF VFPG SVC FOC PG TQCPG FOC PM** Factory Setting:60.0

Settings 30.0~600.0sec

The parameter is set by the output frequency, current and operation time of the drive for activating the I²t electronic thermal protection function. The function will be activated for the 150% * setting current for the setting of Pr.06-13.

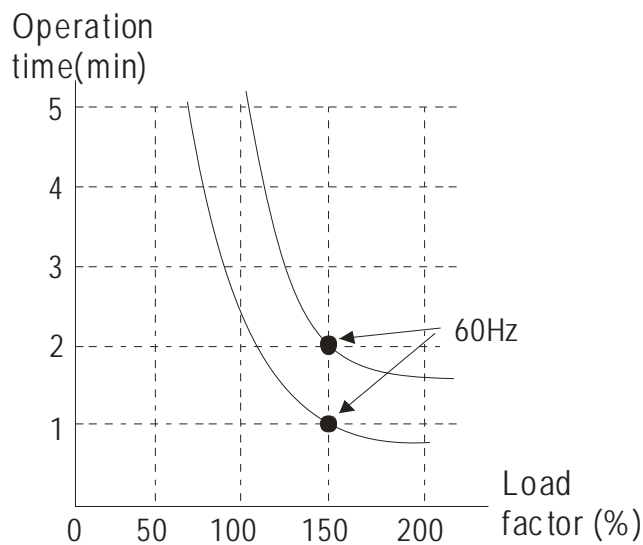

06-14 Heat Sink Over-heat (OH) Warning

Control Mode **VF VFPG SVC FOC PG TQCPG FOC PM** Factory Setting:90.0

Settings 0.0~110.0°C

06-15 Stall Prevention Limit Level

Control Mode **VF VFPG SVC** Factory Setting:50

Settings 0~100% (Refer to Pr06-02, Pr06-03)

When the operating frequency is larger than Pr.01-01, Pr06-02=150%, Pr. 06-03=100% and Pr. 06-15=80%:

Stall Prevention Level during acceleration = 06-02x06-15=150x80%=120%.

Stall Prevention Level at constant speed= 06-03x06-15=100x80%=80%.

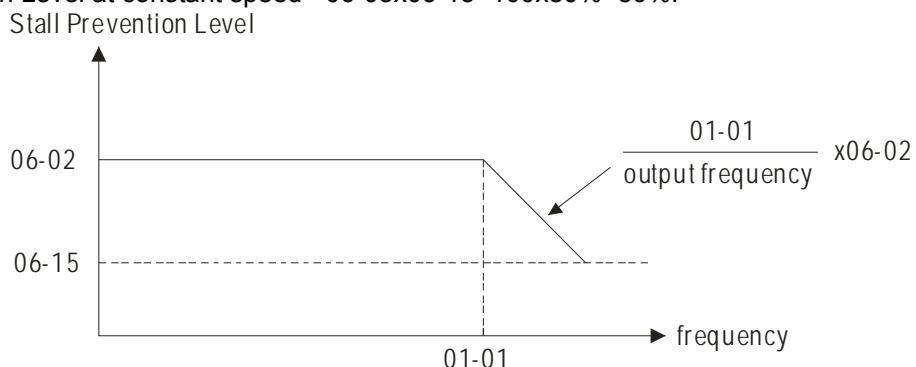

| | |
|--------------|---------------------------------|
| 06-16 | Present Fault Record |
| 06-17 | Second Most Recent Fault Record |
| 06-18 | Third Most Recent Fault Record |
| 06-19 | Fourth Recent Fault Record |
| 06-20 | Fifth Most Recent Fault Record |
| 06-21 | Sixth Most Recent Fault Record |

| Control mode | VF | VFPG | SVC | FOCPG | TQCPG | FOCPM | Factory setting: |
|--------------|----------|------|---------------------------------------------------------|-------|-------|-------|------------------|
| | Readings | 0 | No fault | | | | 0 |
| | | 1 | Over-current during acceleration (ocA) | | | | |
| | | 2 | Over-current during deceleration (ocd) | | | | |
| | | 3 | Over-current during constant speed (ocn) | | | | |
| | | 4 | Ground fault (GFF) | | | | |
| | | 5 | IGBT short-circuit (occ) | | | | |
| | | 6 | Over-current at stop (ocS) | | | | |
| | | 7 | Over-voltage during acceleration (ovA) | | | | |
| | | 8 | Over-voltage during deceleration (ovd) | | | | |
| | | 9 | Over-voltage during constant speed (ovn) | | | | |
| | | 10 | Over-voltage at stop (ovS) | | | | |
| | | 11 | Low-voltage during acceleration (LvA) | | | | |
| | | 12 | Low-voltage during deceleration (Lvd) | | | | |
| | | 13 | Low-voltage during constant speed (Lvn) | | | | |
| | | 14 | Low-voltage at stop (LvS) | | | | |
| | | 15 | Input phase loss (PHL) | | | | |
| | | 16 | IGBT over-heat (oH1) | | | | |
| | | 17 | Bulk capacitor over-heat (oH2) | | | | |
| | | 18 | Abnormal IGBT temperature detected (tH1o) | | | | |
| | | 19 | Abnormal bulk capacitor temperature detected (tH2o) | | | | |
| | | 20 | Unusual cooling fan operation (FAn) | | | | |
| | | 21 | Over-load (oL) (150%; 1 minute, motor drive overloaded) | | | | |
| | | 22 | Motor over-loaded (EoL1) | | | | |
| | | 23 | Reserved | | | | |
| | | 24 | Motor PTC overheat (oH3) | | | | |
| | | 25 | Reserved | | | | |
| | | 26 | Over-torque 1 (ot1) | | | | |
| | | 27 | Over-torque 1 (ot2) | | | | |
| | | 28 | Reserved | | | | |
| | | 29 | Reserved | | | | |
| | | 30 | Memory write-in error (cF1) | | | | |
| | | 31 | Memory read-out error (cF2) | | | | |
| | | 32 | Isum current detection error (cd0) | | | | |
| | | 33 | U-phase current detection error (cd1) | | | | |
| | | 34 | V-phase current detection error (cd2) | | | | |
| | | 35 | W-phase current detection error (cd3) | | | | |
| | | 36 | cc current clamp hardware error (Hd0) | | | | |

| | |
|-------|-----------------------------------------------------------|
| 37 | oc (over-current) hardware error (Hd1) |
| 38 | ov (over-voltage) hardware error (Hd2) |
| 39 | GFF (ground fault) hardware error (Hd3) |
| 40 | Auto tuning error on motor's parameter (AuE) |
| 41 | Reserved |
| 42 | PG feedback error (PGF1) |
| 43 | PG feedback loss (PGF2) |
| 44 | PG feedback stall (PGF3) |
| 45 | PG slip error (PGF4) |
| 46 | Reserved |
| 47 | Reserved |
| 48 | Reserved |
| 49 | External fault input (EF) |
| 50 | Emergency stop by external terminals (EF1) |
| 51 | Reserved |
| 52 | Password error after three attempts (Pcod) |
| 53 | Reserved |
| 54 | Illegal communication command (cE01) |
| 55 | Illegal communication address (cE02) |
| 56 | Communication data length error (cE03) |
| 57 | Communication being written to a read-only address (cE04) |
| 58 | Modbus transmission time-out (cE10) |
| 59 | Keypad transmission time-out (cP10) |
| 60 | Brake chopper error (BF) |
| 61-63 | Reserved |
| 64 | Mechanical brake feedback error (MBF) |
| 65 | PGF5 hardware error |
| 66 | Magnetic contactor error (MCF) |
| 67 | Output phase loss (MPHL) |
| 68 | CAN Bus disconnected |
| 69 | Reserved |
| 70 | Reserved |
| 71 | Reserved |
| 72 | Safety torque loss (STL1) |
| 73 | PGcd hardware error |
| 74 | PG absolute signal error (PGHL) |
| 75 | PG Z phase signal loss (PGAF) |
| 76 | Safety torque output stops(STO) |
| 77 | Safety torque loss 2 (STL2) |
| 78 | Safety torque loss 3 (STL3) |

 It will record when the fault occurs and force stopping. For the Lv, it will record when it is operation, or it will warn without record.

 The definition of codes #69~#71 have been modified in v1.04. See Ch14 for more information

06-30 Setting Method of Fault Output

Control Mode **VF VFBG SVC FOC PG TQCPG FOC PM** Factory Setting: 0

Settings 0: By settings of Pr.06-22~06-25

1: By the binary setting

It is used with the settings 35~38 of Pr.02-11~02-22 (Multi-function Output). The fault output selection 1~4 corresponds to Bit 0~3.

This parameter provides two setting methods for the fault output. Setting 0: it is set by the settings of Pr.06-22~Pr.06-25. Setting 1: it is set by the binary setting. Refer to the following example for details.

Example:

Assume that

Pr.02-13 (Multi-function Output 3 R1A (Relay3)) is set to 35 Fault output option 1 (Pr.06-22).

Pr.02-14 (Multi-function Output 4 R2A (Relay4)) is set to 36 Fault output option 2 (Pr.06-23).

Pr.02-15 (Multi-function Output 5 (MO1)) is set to 37 Fault output option 3 (Pr.06-24).

Pr.02-16 (Multi-function Output 6 (MO2)) is set to 38 Fault output option 4 (Pr.06-25).

Assume that external faults output with the following signal: R1A=1, R2A=1, MO1=0 and MO2=1. The corresponding Bit 3~0 is 1011.

| Bit 3 | Bit 2 | Bit 1 | Bit 0 | Fault code |
|-------|-------|-------|-------|------------------------------------------------------------|
| - | - | - | - | 0: No fault |
| 0 | 0 | 0 | 1 | 1: Over-current during acceleration (ocA) |
| | | | | 2: Over-current during deceleration (ocd) |
| | | | | 3: Over-current during constant speed (ocn) |
| | | | | 4: Ground fault (GFF) |
| | | | | 5: IGBT short-circuit (occ) |
| | | | | 6: Over-current at stop (ocS) |
| 0 | 0 | 1 | 0 | 7: Over-voltage during acceleration (ovA) |
| | | | | 8: Over-voltage during deceleration (ovd) |
| | | | | 9: Over-voltage during constant speed (ovn) |
| | | | | 10: Over-voltage at stop (ovS) |
| 0 | 0 | 1 | 1 | 11: Low-voltage during acceleration (LvA) |
| | | | | 12: Low-voltage during deceleration (Lvd) |
| | | | | 13: Low-voltage during constant speed (Lvn) |
| | | | | 14: Low-voltage at stop (LvS) |
| | | | | 15: Input phase loss (PHL) |
| 0 | 1 | 0 | 0 | 16: IGBT over-heat (oH1) |
| | | | | 17: Bulk capacitor over-heat (oH2) |
| | | | | 18: Abnormal IGBT temperature detected (tH1o) |
| | | | | 19: Abnormal bulk capacitor temperature detected (tH2o) |
| 1 | 0 | 0 | 0 | 20: Unusual cooling fan operation (FAn) |
| 0 | 1 | 0 | 1 | 21: Over-load (oL) (150% 1 minute, motor drive overloaded) |
| 0 | 1 | 1 | 0 | 22: Motor over-load (EoL1) |
| | | | | 24: Motor PTC overheat (oH3) |
| 0 | 1 | 1 | 1 | 26: Over-torque 1 (ot1) |
| | | | | 27: Over-torque 1 (ot2) |
| 1 | 0 | 0 | 0 | 30: Memory write-in error (cF1) |
| | | | | 31: Memory read-out error (cF2) |
| | | | | 32: Isum current detection error (cd0) |
| | | | | 33: U-phase current detection error (cd1) |
| | | | | 34: V-phase current detection error (cd2) |
| | | | | 35: W-phase current detection error (cd3) |
| | | | | 36: cc (current clamp) hardware error (Hd0) |
| | | | | 37: oc (over-current) hardware error (Hd1) |
| | | | | 38: ov (over-voltage) hardware error (Hd2) |
| | | | | 39: GFF (ground fault) hardware error (Hd3) |
| 1 | 0 | 0 | 1 | 40: Auto tuning error on motor's parameter (AUE) |

| Bit 3 | Bit 2 | Bit 1 | Bit 0 | Fault code |
|-------|-------|-------|-------|---------------------------------------------------------------|
| 1 | 0 | 1 | 0 | 41: Reserved |
| | | | | 42: PG feedback error (PGF1) |
| | | | | 43: PG feedback loss (PGF2) |
| 0 | 1 | 1 | 1 | 44: PG feedback stall (PGF3) |
| 1 | 0 | 1 | 0 | 45: PG slip error (PGF4) |
| | | | | 46: Reserved |
| | | | | 47: Reserved |
| 1 | 0 | 1 | 1 | 48: Reserved |
| 1 | 0 | 1 | 1 | 49: External fault input (EF) |
| 1 | 0 | 0 | 1 | 50: Emergency stop by external terminals(EF1) |
| 1 | 0 | 0 | 1 | 52: Password error after three attempts (Pcod) |
| 1 | 1 | 0 | 0 | 54: Illegal communication command (cE01) |
| | | | | 55: Illegal communication address (cE02) |
| | | | | 56: Communication data length error (cE03) |
| | | | | 57: Communication being written to a read-only address (cE04) |
| | | | | 58: Modbus transmission time-out (cE10) |
| 1 | 0 | 0 | 0 | 59: Keypad transmission time-out (cP10) |
| 1 | 0 | 0 | 0 | 60: Brake chopper error (BF) |
| 1 | 0 | 1 | 1 | 63: Reserved |
| | | | | 64: Mechanical brake feedback error (MBF) |
| 1 | 0 | 0 | 0 | 65: PGF5 hardware error |
| 1 | 0 | 1 | 1 | 66: Magnetic contactor error (MCF) |
| 1 | 0 | 1 | 1 | 67: Output phase loss (MPHL) |
| 1 | 1 | 0 | 1 | 68: CAN Bus disconnected (CANF) |
| 1 | 1 | 1 | 0 | 69: Reserved |
| 1 | 1 | 1 | 0 | 70: Reserved |
| 1 | 1 | 1 | 0 | 71: Reserved |
| 1 | 1 | 1 | 0 | 72: Safety torque loss (STL1) |

- ↗ **06-22** Fault Output Option 1
- ↗ **06-23** Fault Output Option 2
- ↗ **06-24** Fault Output Option 3
- ↗ **06-25** Fault Output Option 4

Control Mode **VF VFPG SVC FOC PG TQCPG FOC PM**

Factory Setting: 0

Settings 0~6553 sec (refer to bit table for fault code)

📖 These parameters can be used with multi-function output (set Pr.02-11 to Pr.02-22 to 35-38) for the specific requirement. When a fault occurs, the corresponding terminals will be activated (It needs to convert binary value to decimal value to fill in Pr.06-22 to Pr.06-25).

| Fault code | Bit0 | Bit1 | Bit2 | Bit3 | Bit4 | Bit5 | Bit6 |
|------------------------------------------------------------|---------|-------|------|------|------|------|------|
| | current | Volt. | OL | SYS | FBK | EXI | CE |
| 0: No fault | | | | | | | |
| 1: Over-current during acceleration (ocA) | ● | | | | | | |
| 2: Over-current during deceleration (ocd) | ● | | | | | | |
| 3: Over-current during constant speed (ocn) | ● | | | | | | |
| 4: Ground fault (GFF) | | | | | | ● | |
| 5: IGBT short-circuit (occ) | ● | | | | | | |
| 6: Over-current at stop (ocS) | ● | | | | | | |
| 7: Over-voltage during acceleration (ovA) | | ● | | | | | |
| 8: Over-voltage during deceleration (ovd) | | ● | | | | | |
| 9: Over-voltage during constant speed (ovn) | | ● | | | | | |
| 10: Over-voltage at stop (ovS) | | ● | | | | | |
| 11: Low-voltage during acceleration (LvA) | | ● | | | | | |
| 12: Low-voltage during deceleration (Lvd) | | ● | | | | | |
| 13: Low-voltage during constant speed (Lvn) | | ● | | | | | |
| 14: Low-voltage at stop (LvS) | | ● | | | | | |
| 15: Input phase loss (PHL) | | | | | | ● | |
| 16: IGBT over-heat (oH1) | | | ● | | | | |
| 17: Bulk capacitor over-heat (oH2) | | | ● | | | | |
| 18: Abnormal IGBT temperature detected (tH1o) | | | ● | | | | |
| 19: Abnormal bulk capacitor temperature detected (tH2o) | | | ● | | | | |
| 20: Unusual cooling fan operation (FAn) | | | | | | ● | |
| 21: Over-load (oL) (150% 1 minute, motor drive overloaded) | | | ● | | | | |
| 22: Motor over-load (EoL1) | | | ● | | | | |
| 23: Reserved | | | | | | | |
| 24: Motor PTC overheat (oH3) | | | ● | | | | |
| 25: Reserved | | | | | | | |

| Fault code | Bit0 | Bit1 | Bit2 | Bit3 | Bit4 | Bit5 | Bit6 |
|---------------------------------------------------------------|---------|-------|------|------|------|------|------|
| | current | Volt. | OL | SYS | FBK | EXI | CE |
| 26: Over-torque 1 (ot1) | | | ● | | | | |
| 27: Over-torque 1 (ot2) | | | ● | | | | |
| 28: Reserved | | | | | | | |
| 29: Reserved | | | | | | | |
| 30: Memory write-in error (cF1) | | | | ● | | | |
| 31: Memory read-out error (cF2) | | | | ● | | | |
| 32: Isum current detection error (cd0) | | | | ● | | | |
| 33: U-phase current detection error (cd1) | | | | ● | | | |
| 34: V-phase current detection error (cd2) | | | | ● | | | |
| 35: W-phase current detection error (cd3) | | | | ● | | | |
| 36: cc (current clamp) hardware error (Hd0) | | | | ● | | | |
| 37: oc (over-current) hardware error (Hd1) | | | | ● | | | |
| 38: ov (over-voltage) hardware error (Hd2) | | | | ● | | | |
| 39: GFF (ground fault) hardware error (Hd3) | | | | ● | | | |
| 40: Auto tuning error on motor's parameter (AUE) | | | | ● | | | |
| 41: Reserved | | | | | ● | | |
| 42: PG feedback error (PGF1) | | | | | ● | | |
| 43: PG feedback loss (PGF2) | | | | | ● | | |
| 44: PG feedback stall (PGF3) | | | | | ● | | |
| 45: PG slip error (PGF4) | | | | | ● | | |
| 46: Reserved | | | | | ● | | |
| 47: Reserved | | | | | | ● | |
| 48: Reserved | | | | | | ● | |
| 49: External fault input (EF) | | | | | | ● | |
| 50: Emergency stop by external terminals(EF1) | | | | | | ● | |
| 51: Reserved | | | | | | | |
| 52: Password error after three attempts (Pcod) | | | | ● | | | |
| 53: Reserved | | | | | | | |
| 54: Illegal communication command (cE01) | | | | | | | ● |
| 55: Illegal communication address (cE02) | | | | | | | ● |
| 56: Communication data length error (cE03) | | | | | | | ● |
| 57: Communication being written to a read-only address (cE04) | | | | | | | ● |
| 58: Modbus transmission time-out (cE10) | | | | | | | ● |
| 59: Keypad transmission time-out (cP10) | | | | | | | ● |
| 60: Brake chopper error (BF) | | | | | | ● | |
| 61-62: Reserved | | | | | | | |
| 63: Reserved | | | | ● | | | |

| Fault code | Bit0 | Bit1 | Bit2 | Bit3 | Bit4 | Bit5 | Bit6 |
|-------------------------------------------|---------|-------|------|------|------|------|------|
| | current | Volt. | OL | SYS | FBK | EXI | CE |
| 64: Mechanical brake feedback error (MBF) | | | | | | ● | |
| 65: PGF5 hardware error | | | | ● | | | |
| 66: Magnetic contactor error (MCF) | | | | | | ● | |
| 67: Output phase loss (MPHL) | | | | | | ● | |
| 68: CAN Bus disconnected (CANF) | | | | | | | ● |
| 69: Reserved | | | | ● | | | |
| 70: Reserved | | | | ● | | | |
| 71: Reserved | | | | ● | | | |
| 72: Safety torque loss (STL1) | | | | ● | | | |

 **06-26** PTC (Positive Temperature Coefficient) Detection Selection
 Control Mode **VF VFPG SVC FOC PG TQCPG FOC PM** Factory Setting: 0
 Settings 0: Warn and keep operating
 1: Fault and ramp to stop

 This parameter is to set the treatment after detecting PTC.

 **06-27** PTC Level
 Control Mode **VF VFPG SVC FOC PG TQCPG FOC PM** Factory Setting:50.0
 Settings 0.0~100.0%

 This parameter is to set the PTC level. The corresponding value of 100% PTC level is the max. analog input value.

 **06-28** PTC Filter Time for PTC Detection
 Control Mode **VF VFPG SVC FOC PG TQCPG FOC PM** Factory Setting:0.20
 Settings 0.00~10.00sec

06-29 Voltage of Emergency Power
 Control Mode **VF VFPG SVC FOC PG TQCPG FOC PM** Factory Setting:24.0/48.0
 Settings 24.0~375.0Vdc
 48.0~750.0Vdc

 This parameter needs to work with setting #43 <EPS function> of Pr02-01 ~ Pr02-08<Multi-function input command>.

06-31 Phase Loss Detection of Drive Output at Start-Up(MPHL)
 Control Mode **VF VFPG SVC FOC PG TQCPG FOC PM** Factory Setting: 0
 Settings 0: Disable
 1: Enable

 When it is set to 1, it will auto detect if the connection between the drive and motor is normal whenever the drive runs. If errors occur to the connection between the drive and the motor, the drive will display fault code "67" to indicate motor output phase loss.

06-32 Accumulative Drive Power-on Time at the First Fault (min.)

06-34 Accumulative Drive Power-on Time at the Second Fault (min.)

06-36 Accumulative Drive Power-on Time at the Third Fault (min.)

06-38 Accumulative Drive Power-on Time at the Fourth Fault (min.)

06-40 Accumulative Drive Power-on Time at the Fifth Fault (min.)

06-42 Accumulative Drive Power-on Time at the Sixth Fault (min.)

Control Mode **VF VFPG SVC FOC PG TQCPG** Factory Setting:00
 Settings 00~1439 min

| | |
|--------------|------------------------------------------------------------|
| 06-33 | Accumulative Drive Power-on Time at the First Fault (day) |
| 06-35 | Accumulative Drive Power-on Time at the Second Fault (day) |
| 06-37 | Accumulative Drive Power-on Time at the Third Fault (day) |
| 06-39 | Accumulative Drive Power-on Time at the Fourth Fault (day) |
| 06-41 | Accumulative Drive Power-on Time at the Fifth Fault (day) |
| 06-43 | Accumulative Drive Power-on Time at the Sixth Fault (day) |

Control Mode **VF VFPG SVC FOC PG TQCPG** Factory Setting:00
 Settings 00~65535 day

↗ **06-44** Operation Speed of Emergency Power (EPS) Mode

Control Mode **VF VFPG SVC FOC PG TQCPG FOC PM** Factory Setting: Read Only
 Settings 0.00~400.00Hz

↗ **06-45** Fault and Warning handling methods

Control Mode **VF VFPG SVC FOC PG TQCPG FOC PM** Factory Setting: 0
 Settings Bit0 = 0: Display Lv fault and coast to stop
 Nit0 = 1: Display Lv warn and coast to stop
 Bit1= 0 : Fan lock, fault and coast to stop
 Bit1 = 1: Fan lock, warn and coast to stop
 Bit2 = 0: software GFF protection enabled
 Bit2 = 1: software GFF protection disabled

↗ **06-46** Operation Direction for Emergency Power (EPS) ON

Control Mode **VF VFPG SVC FOC PG TQCPG FOC PM** Factory Setting: 0
 Settings 0 Operate by current command
 1 Operate by the direction of power generating mode
 2 After determining the direction of power generating, the host computer sends the operating direction command. (When at STOP mode determine the direction of power generating mode (MO =32) but do not retain the direction of the power generating.)
 3 After determining the direction of power generating, the host computer send the operating direction command. (When at STOP mode, determine the direction of power generating mode (MO =32) and retain the direction of the power generating.)

📖 Pr.06-46 is enabled when the external terminal is detecting for the emergency power (EPS).

📖 When Pr.06-46 is set to 1 and a forward/reverse run command is given, the drive will begin to detect for the elevator loading and operates in the power regeneration direction (the motor is in power generating status). The drive will use and operate in the direction that was detected as its power regeneration direction. The drive will not operate in user command direction for safety purpose, to prevent voltage drop of emergency power (EPS).

VF and SVC control mode: within the time setting of Pr.06-47, the drive detects the elevator loading status by performing forward/reverse run. Then the elevator operates in power regeneration direction (the motor id in power generating status). Refer to the diagram below for the Auto-Detection Time Graph.

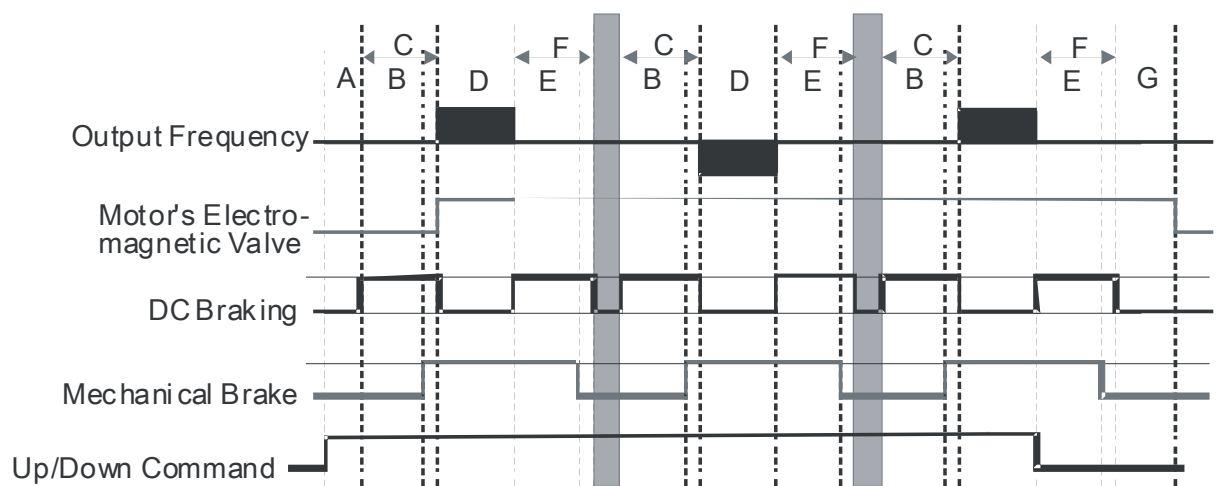
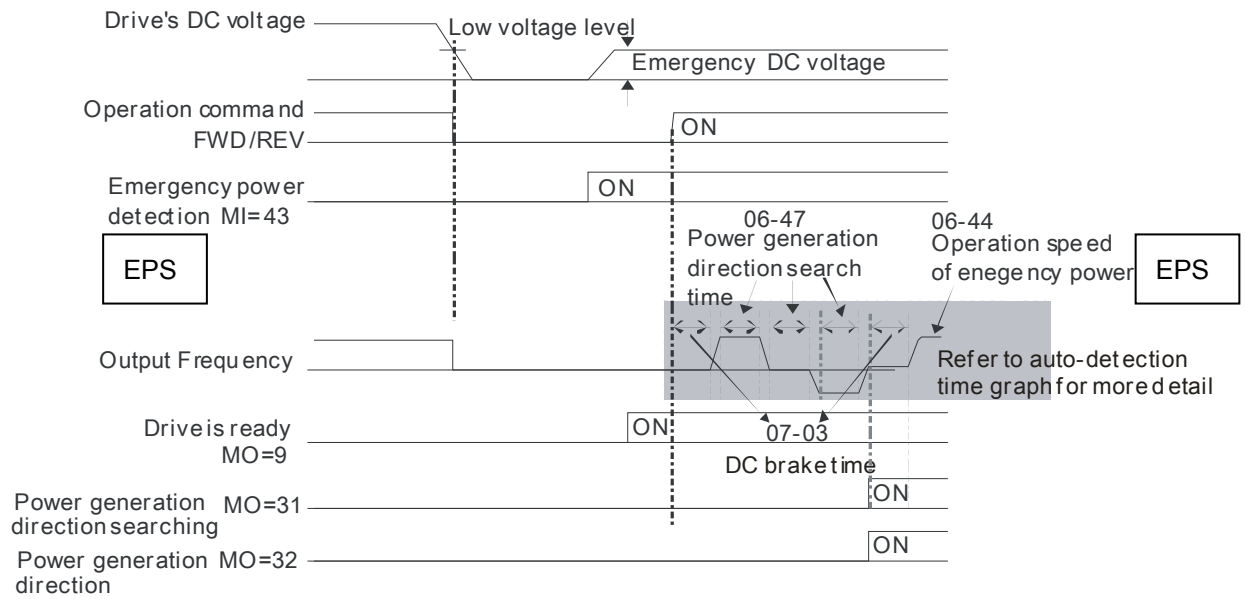

- | | |
|----------------------------------------------------------------------|-----------------------------------------------------------------------|
| A 02-31: Turn On Delay of Magnetic Contactor between Drive and Motor | E 02-30: Brake Engage Delay Time when Elevator Stops |
| B 02-29: Brake Release Delay Time when Elevator Starts | F 07-04: Require DC Brake Time to Stop |
| C 07-03: DC Brake Activation Time | G 02-32: Turn Off Delay of Magnetic Contactor between Drive and Motor |
| D 06-47: Power Generation Direction Searching Time | |

Auto-detection Time Graph

FOCPG/PM Control Mode: within the time setting of Pr.06-47, the drive maintains at zero-speed and it is able to determine the elevator loading without performing forward/reverse run. Then the elevator operates in power regeneration direction (the motor is in power generating status). Refer to the diagram below for the Auto-Detection Time Graph.

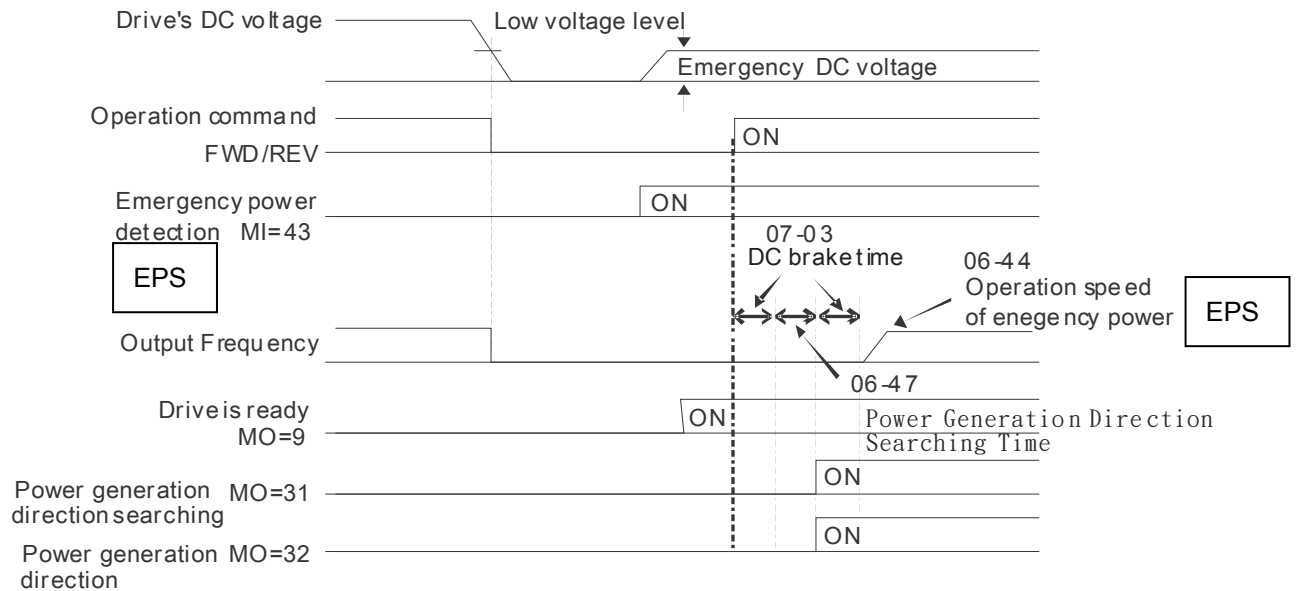

⚡ **06-47** Power Generation Direction Searching Time
 Control Mode **VF VFPG SVC FOC PG TQCPG FOC PM** Factory Setting: 1.0
 Settings 0.0 ~ 5.0sec

06-48 Power Capacity of Emergency Power (EPS)
 Control Mode **VF VFPG SVC FOC PG TQCPG FOC PM** Factory Setting: 0.0
 Settings 0.0 ~ 100.0 kVA

📖 When using emergency power (EPS), user must input the required power capacity for the emergency power and then the AC drive will calculate the acceptable elevator speed (Pr.06-44) by following equation.



$$V_{eps_max} = \frac{06-48 \times 0.5}{\sqrt{3} \times I_{motor_rated}}$$

$$f_{eps_limit} = \frac{V_{eps_max}}{01-02} \times 01-01 \times 0.5$$

$$I_{motor_rated} = 05-01 \text{ (Induction Motor)} / 08-01 \text{ (PM Motor)}$$

- 📖 When Frequency Command f_{EPS} , the operation speed of emergency power (EPS) is f_{EPS} .
- 📖 When Frequency Command $\leq f_{EPS}$, the operation speed of emergency power (EPS) is set by current frequency command.

06-49 STO Latch Selection
 Control Mode **VF VFPG SVC FOC PG TQCPG FOC PM** Factory Setting: 0
 Settings 0: STO alarm Latch

- 1: STO alarm no Latch
- 2: STO Latch (Warn and record running commands when stop)
- 3: STO No Latch (Warn and record running commands when stop)

- 📖 When Pr06-49=0, STO alarm is latched which means once the cause of the alarm is cleared, a Reset command is required to clear the STO alarm.
- 📖 When Pr06-49=1, STO alarm is NOT latched which means once the cause of the alarm is cleared, the STO alarm will stop automatically.
- 📖 When in STL1~STL3 mode, STO alarm is latched and Pr06-49 cannot be set.

06-50 Selection of MO's action when retrying after fault

| | | |
|--------------|-------------------------------------------------------------------------|--------------------|
| Control Mode | VF VFPG SVC FOCPG TQCPG FOCPM | Factory Setting: 0 |
| Settings | 0: Output 1: NO output | |

To determine if to display fault indication when the following faults have occurred:

- 7: Over-voltage during acceleration (ovA)
- 8: Over-voltage during deceleration (ovd)
- 9: Over-voltage during constant speed (ovn)
- 10: Over-voltage at stop (ovS)
- 11: Low-voltage during acceleration (LvA)
- 12: Low-voltage during deceleration (Lvd)
- 13: Low-voltage during constant speed (Lvn)
- 14: Low-voltage at stop (LvS)
- 15: Input Phase loss (PHL)

Two MO terminals are affected by this parameters and should be set up as

MO= 10: Low voltage waning (LV)

MO= 11: Fault Indication

06-51 Number of times of retrying after fault

| | | |
|--------------|-------------------------------------------------------------------------|--------------------|
| Control Mode | VF VFPG SVC FOCPG TQCPG FOCPM | Factory Setting: 0 |
| Settings | 0~10 times | |

To determine number of times to retry when the following faults have occurred:

- 7: Over-voltage during acceleration (ovA)
- 8: Over-voltage during deceleration (ovd)
- 9: Over-voltage during constant speed (ovn)
- 10: Over-voltage at stop (ovS)
- 11: Low-voltage during acceleration (LvA)
- 12: Low-voltage during deceleration (Lvd)
- 13: Low-voltage during constant speed (Lvn)
- 14: Low-voltage at stop (LvS)
- 15: Input Phase loss (PHL)

After every reattempt, the available number of times to retry will automatically be deducted as displayed on the keypad

About number of time to reset

1. Reset the fault manually
2. After running normally for 10 minutes, the motor drive will be back to the prior setting.
3. The motor drive will be powered-down and powered-up again.

06-52 Time interval between retrying

| | | |
|--------------|-------------------------------------------------------------------------|--------------------|
| Control Mode | VF VFPG SVC FOCPG TQCPG FOCPM | Factory Setting: 0 |
| Settings | 0.5~600.0 sec. | |

To determine time interval between retrying when the following faults have occurred:

- 7: Over-voltage during acceleration (ovA)
- 8: Over-voltage during deceleration (ovd)
- 9: Over-voltage during constant speed (ovn)
- 10: Over-voltage at stop (ovS)
- 11: Low-voltage during acceleration (LvA)
- 12: Low-voltage during deceleration (Lvd)
- 13: Low-voltage during constant speed (Lvn)
- 14: Low-voltage at stop (LvS)
- 15: Input Phase loss (PHL)

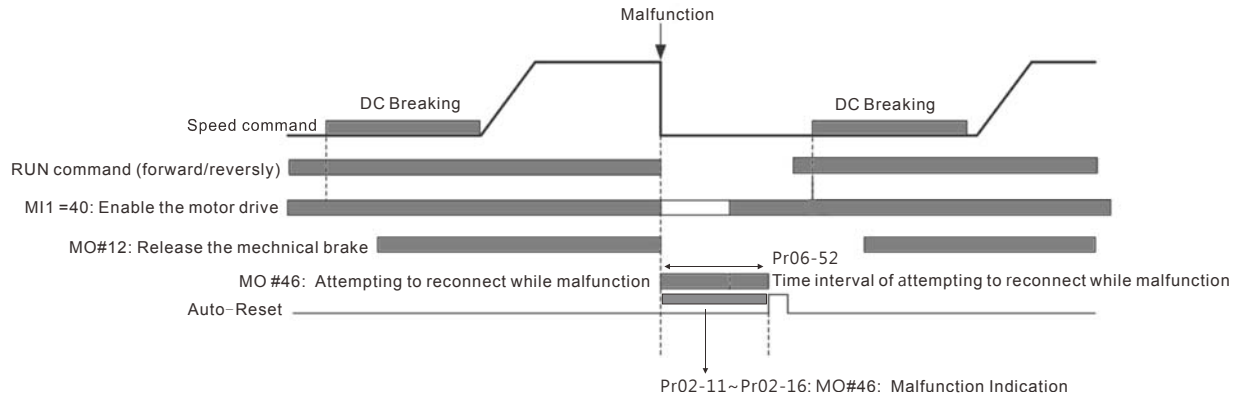

- 06-53 Frequency command when the most recent fault has occurred
 Control Mode **VF** **VFPG** **SVC** **FOCPG** **TQCPG** **FOCPM** Factory Setting: 0.00
 Settings 0.00~655.35Hz
- 06-54 Output frequency when the most recent fault has occurred
 Control Mode **VF** **VFPG** **SVC** **FOCPG** **TQCPG** **FOCPM** Factory Setting: 0.00
 Settings 0.00~655.35Hz
- 06-55 Output current when the most recent fault has occurred
 Control Mode **VF** **VFPG** **SVC** **FOCPG** **TQCPG** **FOCPM** Factory Setting : 0.00
 Settings 0.00~655.35Amps
- 06-56 Output current when the most recent fault has occurred
 Control Mode **VF** **VFPG** **SVC** **FOCPG** **TQCPG** **FOCPM** Factory Setting : 0.00
 Settings 0.00~655.35Hz
- 06-57 Output voltage when the most recent fault has occurred
 Control Mode **VF** **VFPG** **SVC** **FOCPG** **TQCPG** **FOCPM** Factory Setting: 0.0
 Settings 0.00~6553.5V
- 06-58 DC bus voltage when the most recent fault has occurred
 Control Mode **VF** **VFPG** **SVC** **FOCPG** **TQCPG** **FOCPM** Factory Setting : 0.0
 Settings 0.00~6553.5V
- 06-59 Output power when the most recent fault has occurred
 Control Mode **VF** **VFPG** **SVC** **FOCPG** **TQCPG** **FOCPM** Factory Setting : 0.0
 Settings 0.00~6553.5kW
- 06-60 Output torque when the most recent fault has occurred
 Control Mode **VF** **VFPG** **SVC** **FOCPG** **TQCPG** **FOCPM** Factory Setting:0.00
 Settings 0.00~655.35%

| | | |
|--------------|----------------------------------------|------------------------------------------------------------------------|
| ↗ | 06-61 | IGBT's temperature when the most recent fault has occurred |
| Control Mode | VF VFPG SVC FOC PG TQCPG FOC PM | Factory Setting: 0.0 |
| Settings | -3276.8~3276.7°C | |
| ↗ | 06-62 | Multi-input terminals' status when the most recent fault has occurred |
| Control Mode | VF VFPG SVC FOC PG TQCPG FOC PM | Factory Setting: 0000h |
| Settings | 0000h~FFFFh | |
| ↗ | 06-63 | Multi-output terminals' status when the most recent fault has occurred |
| Control Mode | VF VFPG SVC FOC PG TQCPG FOC PM | Factory Setting: 0000h |
| Settings | 0000h~FFFFh | |
| ↗ | 06-64 | Motor drive's status when the most recent fault has occurred |
| Control Mode | VF VFPG SVC FOC PG TQCPG FOC PM | Factory Setting: 0000h |
| Settings | 0000h~FFFFh | |

07 Special Parameters

07-00 Brake Chopper Level

Control Mode **VF** **VFPG** **SVC** **FOCPG** **TQCPG** **FOCPM**

Factory Setting: 380.0/760.0

Settings 230V series: 350.0~450.0Vdc
460V series: 700.0~900.0Vdc

This parameter sets the DC-bus voltage at which the brake chopper is activated.

07-01 Reserved

07-02 DC Brake Current Level

Control Mode **VF** **VFPG** **SVC**

Factory Setting: 0

Settings 0~100% (rated current of the motor drive)

This parameter sets the level of DC Brake Current output to the motor during start-up and stopping. When setting DC Brake Current, the Rated Current (Pr.00-01) is regarded as 100%. It is recommended to start with a low DC Brake Current Level and then increase until proper holding torque has been attained.

When it is in FOCPG/TQCPG/FOCPM mode, it can enable DC brake function by setting to any value.

07-03 DC Brake Activation Time

Control Mode **VF** **VFPG** **SVC** **FOCPG** **FOCPM**

Factory Setting: 0.7

Settings 0.0~60.0sec

This parameter sets the duration of DC Brake current is supplied to motor when activating the drive.

07-04 DC Brake Stopping Time

Control Mode **VF** **VFPG** **SVC** **FOCPG** **FOCPM**

Factory Setting: 0.7

Settings 0.0~60.0sec

This parameter sets the duration of DC Brake current is supplied to motor when stopping the drive.

07-05 Start-Point for DC Brake

Control Mode **VF** **VFPG** **SVC** **FOCPG**

Factory Setting: 0.00

Settings 0.00~400.00Hz

This parameter determines the frequency when DC Brake will begin during deceleration. When the setting is less than start frequency (Pr.01-09), start-point for DC brake will begin from the min. frequency.

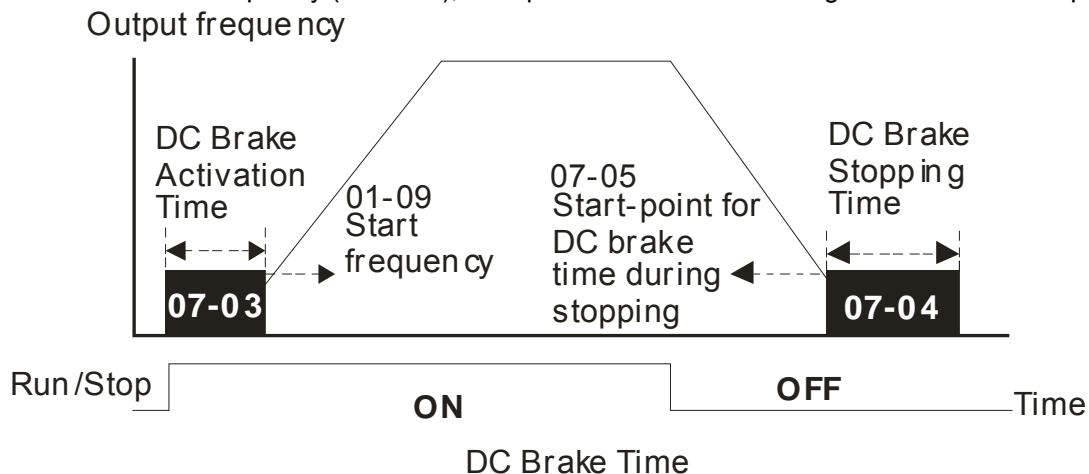

↗ **07-06** DC Brake Proportional Gain
 Control Mode **VF VFPG SVC** Factory Setting:50
 Settings 1~500

📖 It is used to set the output voltage gain when DC brakes.

↗ **07-07** Dwell Time at Accel.
 Control Mode **VF VFPG SVC FOC PG FOC PM** Factory Setting:0.00
 Settings 0.00~600.00sec

↗ **07-09** Dwell Time at Decel.
 Control Mode **VF VFPG SVC FOC PG FOC PM** Factory Setting:0.00
 Settings 0.00~600.00sec

↗ **07-08** Dwell Frequency at Accel.
 Control Mode **VF VFPG SVC FOC PG FOC PM** Factory Setting:0.00
 Settings 0.00~400.00Hz

↗ **07-10** Dwell Frequency at Decel.
 Control Mode **VF VFPG SVC FOC PG FOC PM** Factory Setting:0.00
 Settings 0.00~400.00 Hz

📖 In the heavy load situation, Dwell can make stable output frequency temporarily.

📖 Pr.07-07 to Pr.07-10 are for heavy load to prevent OV or OC occurs.

Frequency

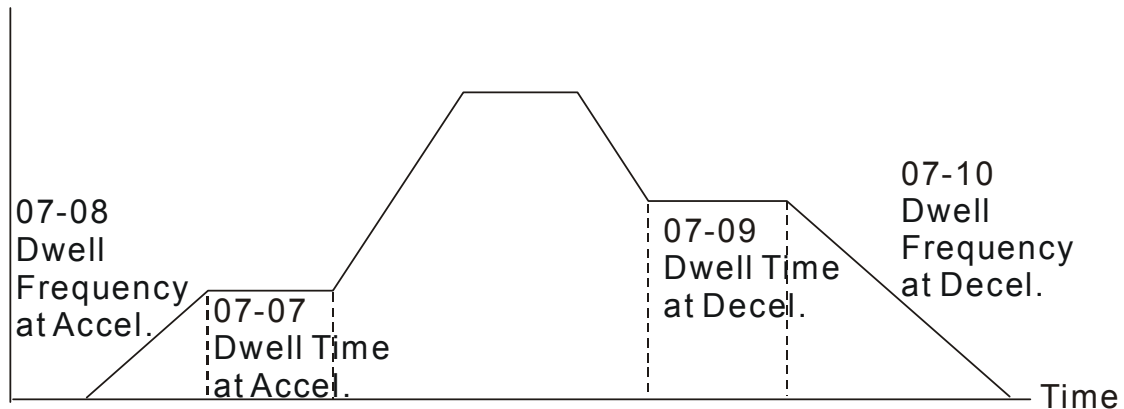

Dwell at accel./decel.

↗ **07-11** Cooling Fan Control
 Control Mode **VF VFPG SVC FOC PG TQCPG FOC PM** Factory Setting:2
 Settings 0: Fan always ON

- 1: 1 minute after AC motor drive stops, cooling fan will be OFF
- 2: AC motor drive runs and fan ON, AC motor drive stops and cooling fan OFF
- 3: Cooling fan ON to run when preliminary heat sink temperature attained
- 4: Cooling fan always OFF

📖 This parameter is used for the fan control.

📖 When setting to 3, fan will start to run until temperature is less than 40°C if temperature exceeds 40°C.

➤ **07-12** Torque Command

Control Mode **TQCPG** Factory Setting:0.0
 Settings -150.0 to 150.0% (Pr. 07-14 setting=100%)

📖 This parameter is torque command. When Pr.07-14 is 250% and Pr.07-12 is 100%, the actual torque command = 250X100% X motor rated torque.

➤ **07-13** Source of Torque Command

Control Mode **TQCPG** Factory Setting:2
 Settings 0: KPC-CC01 Digital keypad
 1: RS485 serial communication
 2: Analog signal (Pr.03-00)

📖 This parameter is torque command source and the torque command is in Pr.07-12

➤ **07-14** Maximum Torque Command

Control Mode **VF VFBG SVC FOC PG TQCPG FOC PM** Factory Setting:100
 Settings 0~300% (rated torque of the motor drive)

📖 This parameter is for the max. torque command (motor rated torque is 100%).

➤ **07-15** Filter Time of Torque Command

Control Mode **TQCPG** Factory Setting:0.000
 Settings 0.000~1.000sec

📖 When the setting is too long, the control will be stable but the control response will be delay. When the setting is too short, the response will be quickly but the control maybe unstable. User can adjust the setting by the control and response situation.

07-16 Speed Limit Selection

Control Mode **TQCPG** Factory Setting: 0
 Settings 0: By Pr.07-17 and Pr.07-18
 1: Frequency command source (Pr.00-14)

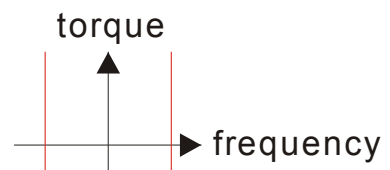

07-18 07-17
 Pr.07-16=0
 Running/opposite running direction are limited by Pr.07-17 and Pr.07-18.

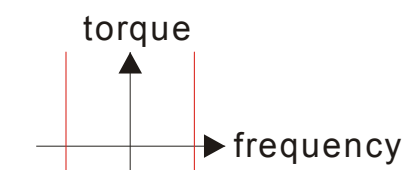

07-18 00-14
 07-16=1
 When it is forward running, running direction is limited by Pr.00-14
 opposite running direction is limited by Pr.07-18.

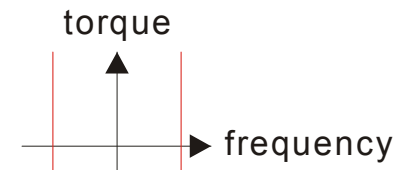

00-14 07-17
 07-16=1
 When it is reverse running, running direction is limited by Pr.07-17
 opposite running direction is limited by Pr.00-14.

↗ **07-17** Torque Mode + Speed Limit
 Control Mode **TQCPG** Factory Setting:10
 Settings 0~120%

↗ **07-18** Torque Mode - Speed Limit
 Control Mode **TQCPG** Factory Setting:10
 Settings 0~120%

📖 These parameters are used in the torque mode to limit the running direction and opposite direction. (Pr.01-00 max. output frequency=100%)

↗ **07-19** Source of Torque Offset
 Control Mode **SVC FOC PG TQCPG FOC PM** Factory Setting: 0
 Settings 0: Disable
 1: Analog input (Pr.03-00)
 2: Torque offset setting (Pr.07-20)
 3: Control by external terminal (by Pr.07-21 to Pr.07-23)

📖 This parameter is the source of torque offset.

📖 When it is set to 3, the source of torque offset will decide to Pr.07-21, Pr.07-22 and Pr.07-23 by the multi-function input terminals setting (31, 32 or 33).

| 02-01~02-08 is set to31 | 02-01~02-08 is set to32 | 02-01~02-08 is set to 33 | Torque offset |
|-------------------------|-------------------------|--------------------------|-------------------|
| OFF | OFF | OFF | N/A |
| OFF | OFF | ON | 07-23 |
| OFF | ON | OFF | 07-22 |
| OFF | ON | ON | 07-23+07-22 |
| ON | OFF | OFF | 07-21 |
| ON | OFF | ON | 07-21+07-23 |
| ON | ON | OFF | 07-21+07-22 |
| ON | ON | ON | 07-21+07-22+07-23 |

↗ **07-20** Torque Offset Setting
 Control Mode **SVC FOC PG TQCPG FOC PM** Factory Setting:0.0
 Settings 0.0~100.0% (rated torque of the motor drive)

📖 This parameter is torque offset. The motor rated torque is 100%.

↗ **07-21** High Torque Offset
 Control Mode **SVC FOC PG TQCPG FOC PM** Factory Setting:30.0
 Settings 0.0~100.0% (rated torque of the motor drive)

↗ **07-22** Middle Torque Offset
 Control Mode **SVC FOC PG TQCPG FOC PM** Factory Setting:20.0
 Settings 0.0~100.0% (rated torque of the motor drive)

↗ **07-23** Low Torque Offset
 Control Mode **SVC FOC PG TQCPG FOC PM** Factory Setting:10.0
 Settings 0.0~100.0% (rated torque of the motor drive)

📖 When it is set to 3, the source of torque offset will decide to Pr.07-21, Pr.07-22 and Pr.07-23 by the multi-function input terminals setting (19, 20 or 21). The motor rated torque is 100%.

- ↗ **07-24** Forward Motor Torque Limit
- ↗ **07-25** Forward Regenerative Torque Limit
- ↗ **07-26** Reverse Motor Torque Limit
- ↗ **07-27** Reverse Regenerative Torque Limit

Control Mode

FOCPG TQCPG FOCPM

Factory Setting:200

Settings 0~300% (rated torque of the motor drive)

- 📖 The motor rated torque is 100%. The settings for Pr.07-24 to Pr.07-27 will compare with Pr.03-00=5, 6, 7, 8. The minimum of the comparison result will be torque limit.
- 📖 The motor rated torque is 100%. The settings for Pr.07-24 to Pr.07-27 will compare with Pr.03-00=5, 6, 7, 8. The minimum of the comparison result will be torque limit.

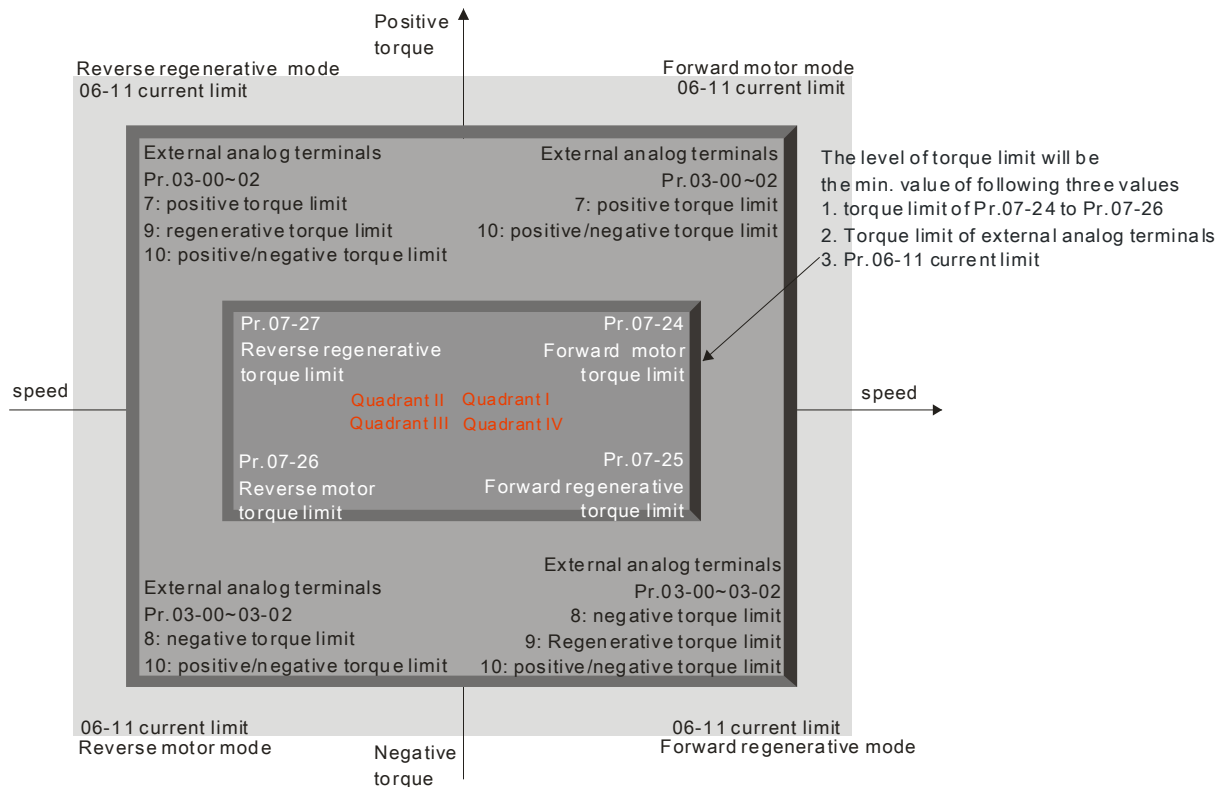

↗ **07-28** Emergency Stop (EF) & Forced Stop Selection

Control Mode

VF VFPG SVC FOCPG TQCPG FOCPM

Factory Setting: 0

- Settings 0: Coast to stop
- 1 : By deceleration Time 1
 - 2 : By deceleration Time 2
 - 3 : By deceleration Time 3
 - 4 : By deceleration Time 4
 - 5 : By Pr.01-31

- 📖 When the multi-function input terminal is set to 10 or 14 and it is ON, the AC motor drive will be operated by Pr.07-28.

↗ **07-29** Time for Decreasing Torque at Stop

Control Mode

FOCPG TQCP FOCM

Factory Setting:0.000

G M

Settings 0.000~1.000sec

- 📖 When the elevator is stop and the mechanical brake is engaged, the drive will stop output. At the same time, it will produce the noise from the reacting force between the motor and the mechanical brake. This parameter can be used to decrease this reacting force and lower the noise.
- 📖 It is used to set the time for decreasing torque to 0%.

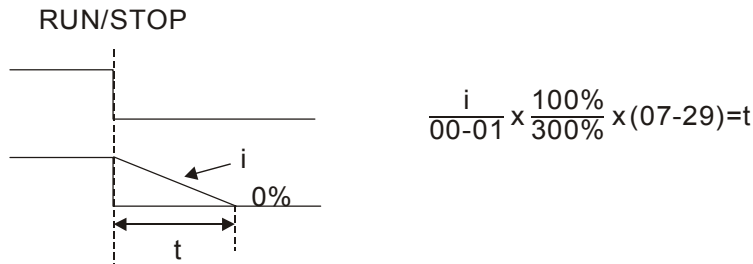

↘ **07-30** DC Braking Current Level

Control Mode **VF** **VFP** **SVC**

Factory Setting: 0

Settings; 0~100% (rated current of the motor drive)

- 📖 This parameter determines the amount of DC Braking Current applied to the motor during starting and stopping. When setting the DC Braking Current, note that 100% corresponds to the rated current of the AC drive. It is recommended to start with a low DC Braking Current level and then increase it slowly until proper holding torque has been attained. The amount of DC Braking Current cannot be higher than the rated current to avoid burning out the motor. So do not use DC brake of the motor drive as the mechanical latching to prevent accidents.
- 📖 When in FOCPG/TQCPG/FOCPM control mode, DC brake can be enabled without setting up Pr07-30.

08 PM Parameters

08-00

Motor Auto Tuning

Control Mode

FOCPM

Factory Setting: 0

Settings 0: No function

1: Only for the unloaded motor, auto measure the angle between magnetic pole and PG origin (08-09)

2: For PM parameters (brake locked)

3: Auto measure the angle between magnetic pole and PG origin (08-09)



For setting 1: It can auto measure the angle between magnetic pole and PG origin. Follow the steps below when measuring:

1. Unload before tuning
2. If brake is controlled by drive, the drive will act by the normal operation to finish tuning after wiring and setting brake control parameter
3. brake is controlled by drive, the drive will act by the normal operation to finish tuning after wiring and setting brake control parameter



For setting 3: It can auto measure the angle between magnetic pole and PG origin. Follow the steps below when measuring:

1. It can be loaded motor or unloaded motor before tuning
2. If brake is controlled by drive, the drive will act by the normal operation to finish tuning after wiring and setting brake control parameters
3. If brake is controlled by the host controller, it needs to make sure that brake is in release state before tuning
4. Make sure the setting of Pr.10-02 is correct. Because the wrong setting of Pr.10-02 will cause wrong position of magnetic pole and also the wrong angle between magnetic pole and PG origin



For setting 2: Starting auto tuning by pressing RUN key and it will write the measure value into Pr.08-05, Pr.08-07 (Rs, Lq) and Pr.08-08 (back EMF).

The steps to AUTO-Tuning are: (Static measure)

1. Make sure that all the parameters are set to factory settings and the motor wiring is correct
2. Motor: Fill in Pr.08-01, Pr.08-02, Pr.08-03 and Pr.08-04 with correct values. Refer to motor capacity to set accel. /decel. time
3. When Pr.08-00 is set to 2, the AC motor drive will execute auto-tuning immediately after receiving a "RUN" command. (NOTE: the motor will run! The shaft needs to be locked with external force)
4. After executing, Check if all values are filled in Pr.08-05 and Pr.08-07

 **NOTE**

- The rated speed can't be larger or equal to 120f/p.
- Note that if the electromagnetic valve and brake is not controlled by the AC motor drive, release it manually
- It is recommended to set Pr.08-00 to 1 (unloaded motor) for the accurate calculation. If it needs to execute this function with loaded motor, balance the carriage before execution.
- If it doesn't allow balancing the carriage in the measured environment, it can set Pr.08-00=3 for executing this function. It can execute this function with loaded motor by setting Pr.08-00=3. It will have a difference of 15~30° by the different encoder type. Also refer to the reference table for tuning in Pr10-00 <PG Signal Type>.
- It will display the warning message "Auto tuning" on the digital keypad during measuring until the measure is finished. Then, the result will be saved into Pr.08-09.
- It will display "Auto Tuning Err" on the keypad when stopping by the fault of the AC motor drive or human factor to show the failed detection. At this moment, please check the connections of the wirings of the AC motor drives. If it displays "PG Fbk Error" on the digital keypad, please change the setting of Pr.10-02 (if it is set to 1, please change it to 2). If it displays "PG Fbk Loss" on the digital keypad, please check the feedback of Z-phase pulse.

08-01 Full-load Current of Motor

| | | |
|--------------------------------|--------------|----------------------|
| Control Mode | FOCPM | Unit: Amp |
| | | Factory Setting: ### |
| Settings (40~120%) *00-01 Amps | | |

 This value should be set according to the rated frequency of the motor as indicated on the motor nameplate. The factory setting is 90% X rated current.
Example: if the rated current for 7.5hp (5.5kW) models is 25A and the factory setting is 22.5A. In this way, the current range will be from 10A (25*40%) to 30A (25*120%).

 **08-02** Rated Power of Motor

| | | |
|-------------------------|--------------|----------------------|
| Control Mode | FOCPM | Factory Setting: ### |
| Settings 0.00~655.35 kW | | |

 It is used to set rated power of the motor. The factory setting is the power of the drive.

 **08-03** Rated Speed of Motor (rpm)

| | | |
|----------------------|--------------|-----------------------|
| Control Mode | FOCPM | Factory Setting: 1710 |
| Settings 0~65535 rpm | | |

 It is used to set the rated speed of the motor and need to set according to the value indicated on the motor nameplate.

08-04 Number of Motor Poles

| | | |
|--------------|--------------|-------------------|
| Control Mode | FOCPM | Factory Setting:4 |
| Settings | 2~96 | |

 It is used to set the number of motor poles (must be an even number).

08-05 Rs of Motor

| | | |
|--------------|---------------|-----------------------|
| Control Mode | FOCPM | Factory Setting:0.000 |
| Settings | 0.000~65.535Ω | |

08-06 Ld of Motor**08-07** Lq of Motor

| | | |
|--------------|--------------|---------------------|
| Control Mode | FOCPM | Factory Setting:0.0 |
| Settings | 0.0~6553.5mH | |

08-08 Back Electromotive Force

| | | |
|--------------|----------------|---------------------|
| Control Mode | FOCPM | Factory Setting:0.0 |
| Settings | 0.0~6553.5Vrms | |

 This parameter is used to set back electromotive force (phase-phase RMS value) when the motor is operated in the rated speed.

 It can get RMS value by Pr.08-00=2 (Motor Auto Tuning).

08-09 Angle between Magnetic Pole and PG Origin

| | | |
|--------------|--------------|-----------------------|
| Control Mode | FOCPM | Factory Setting:360.0 |
| Settings | 0.0~360.0° | |

 This function is used to measure the angle between magnetic pole and PG origin.

08-10 Magnetic Pole Re-orientation

| | | |
|--------------|-------------------------|--------------------|
| Control Mode | FOCPM | Factory Setting: 0 |
| Settings | 0: Disable 1: Enable | |

 Use with Pr.11-00 bit15=1.

 This function is used for searching magnetic pole position and only for permanent magnet motor.

 When it doesn't have origin-adjustment for encoder (Pr.08-09 is 360.0), it can only ensure that the motor operation efficiency can be up to 86% of the best efficiency. In this situation, when the operation efficiency needs to be improved, user can re-power on or set Pr.08-10 to 1 to get the magnetic pole orientation

09 Communication Parameters

When using communication devices, connects AC drive with PC by using Delta IFD6530 or IFD6500.

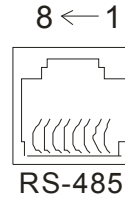

Modbus RS-485

Pin 1~2,7,8: Reserved

Pin 3, 6: GND

Pin 4: SG-

Pin 5: SG+

09-00 Communication Address

Factory Setting:1

Settings 1~254

If the AC motor drive is controlled by RS-485 serial communication, the communication address for this drive must be set via this parameter. And the communication address for each AC motor drive must be different and unique.

09-01 Transmission Speed

Control Mode **VF** **VFP** **SVC** **FOCP** **TQCP** **FOCP**

Factory Setting:19.2

Settings 4.8~115.2kbts/s

This parameter is used to set the transmission speed between the RS485 master (PLC, PC, etc.) and AC motor drive.

09-02 Transmission Fault Treatment

Control Mode **VF** **VFP** **SVC** **FOCP** **TQCP** **FOCP**

Factory Setting:3

Settings 0: Warn and keep operating

1: Warn and RAMP to stop

2: Reserved

3: No action and no display

This parameter is set to how to react if transmission errors occur.

09-03 Time-out Detection

Control Mode **VF** **VFP** **SVC** **FOCP** **TQCP** **FOCP**

Factory Setting:0.0

Settings 0.0~100.0sec

0.0: disable

It is used to set the communication time-out time.

Control Mode **VF VFPG SVC FOCPG TQCPG FOCPM** Factory Setting:13

- Settings
- 0 : 7 · N · 1 for ASCII
 - 1 : 7 · N · 2 for ASCII
 - 2 : 7 · E · 1 for ASCII
 - 3 : 7 · O · 1 for ASCII
 - 4 : 7 · E · 2 for ASCII
 - 5 : 7 · O · 2 for ASCII
 - 6 : 8 · N · 1 for ASCII
 - 7 : 8 · N · 2 for ASCII
 - 8 : 8 · E · 1 for ASCII
 - 9 : 8 · O · 1 for ASCII
 - 10 : 8 · E · 2 for ASCII
 - 11 : 8 · O · 2 for ASCII
 - 12 : 8 · N · 1 for RTU
 - 13 : 8 · N · 2 for RTU
 - 14 : 8 · E · 1 for RTU
 - 15 : 8 · O · 1 for RTU
 - 16 : 8 · E · 2 for RTU
 - 17 : 8 · O · 2 for RTU

 Control by PC or PLC (Computer Link)

Users can select the desired mode along with the RS-485 serial port communication protocol in Pr.09-00.

 MODBUS ASCII(American Standard Code for Information Interchange): Each byte data is the combination of two ASCII characters. For example, a 1-byte data: 64 Hex, shown as '64' in ASCII, consists of '6' (36Hex) and '4' (34Hex).

1. Code Description:

Communication protocol is in hexadecimal, ASCII: "0", "9", "A", "F", every 16 hexadecimal represents ASCII code. For example:

| | | | | | | | | |
|------------|-----|-----|-----|-----|-----|-----|-----|-----|
| Character | '0' | '1' | '2' | '3' | '4' | '5' | '6' | '7' |
| ASCII code | 30H | 31H | 32H | 33H | 34H | 35H | 36H | 37H |

| | | | | | | | | |
|------------|-----|-----|-----|-----|-----|-----|-----|-----|
| Character | '8' | '9' | 'A' | 'B' | 'C' | 'D' | 'E' | 'F' |
| ASCII code | 38H | 39H | 41H | 42H | 43H | 44H | 45H | 46H |

2. Data Format

10-bit character frame (For ASCII):

(Format: 7, N, 2)

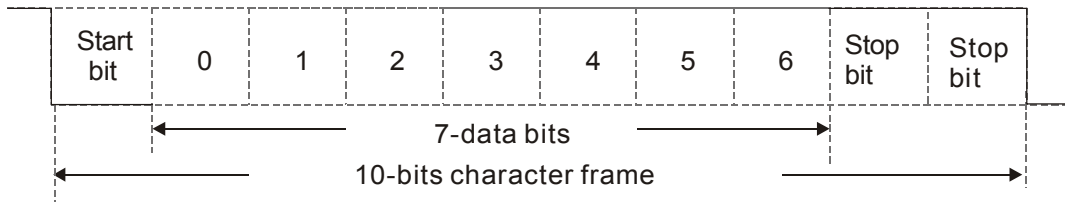

(Format: 7, E, 1)

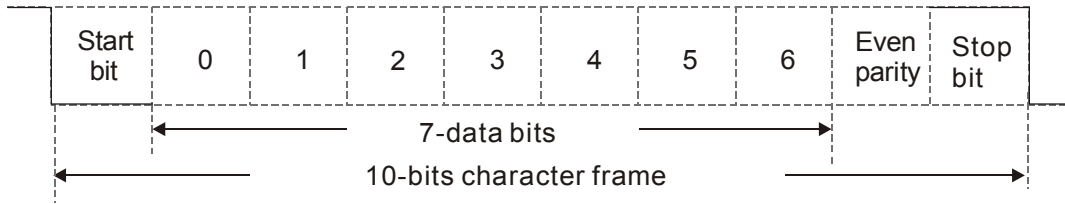

(Format: 7, O, 1)

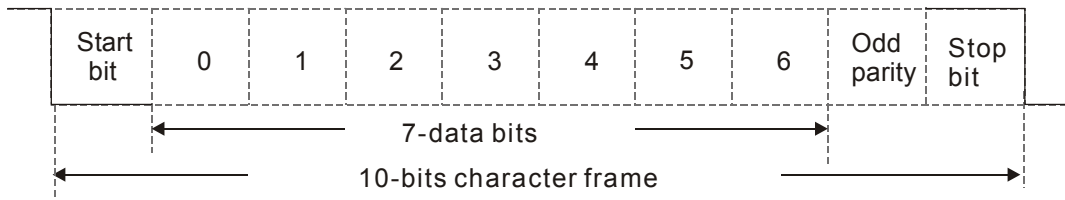

11-bit character frame (For RTU)

(Format: 8, N, 2)

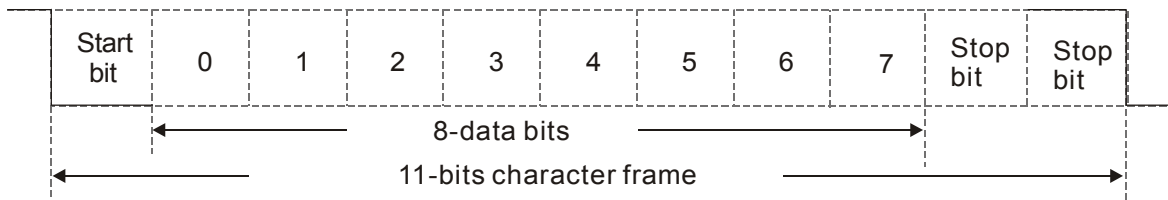

(Format: 8, E, 1)

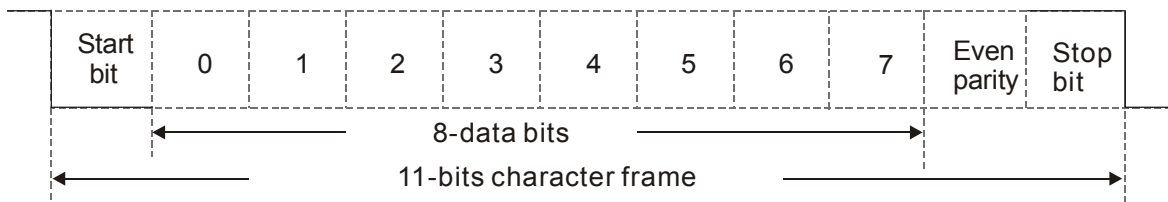

(Format 8, O, 1)

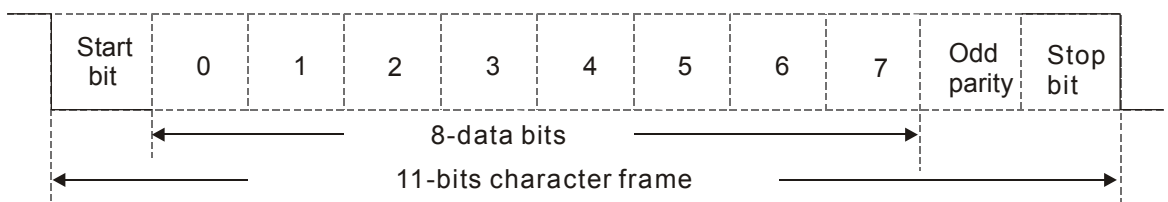

3. Communication Protocol

3.1 Communication Data Frame

ASCII mode

| | |
|----------------------------|-------------------------------------------------------------------------------------------------|
| STX | Start character ‘:’ (3AH) |
| Address Hi | Communication address: 8-bit address consists of 2 ASCII codes |
| Address Lo | |
| Function Hi | Command code: 8-bit command consists of 2 ASCII codes |
| Function Lo | |
| DATA (n-1) to DATA 0 | Contents of data: Nx8-bit data consist of 2n ASCII codes n<=16, maximum of 32 ASCII codes |
| LRC CHK Hi | LRC check sum: 8-bit check sum consists of 2 ASCII codes |
| LRC CHK Lo | |
| END Hi | End characters: END1= CR (0DH), END0= LF(0AH) |
| END Lo | |

RTU mode:

| | |
|----------------------------|-------------------------------------------------------------------|
| START | A silent interval of more than 10 ms |
| Address | Communication address: 8-bit address |
| Function | Command code: 8-bit command |
| DATA (n-1) to DATA 0 | Contents of data: n×8-bit data, n<=16 |
| CRC CHK Low | CRC check sum: 16-bit check sum consists of 2 8-bit characters |
| CRC CHK High | |
| END | A silent interval of more than 10 ms |

3.2 Address (Communication Address)

Valid communication addresses are in the range of 0 to 254. A communication address equal to 0 means broadcast to all AC drives (AMD). In this case, the AMD will not reply any message to the master device.

00H: broadcast to all AC drives

01H: AC drive of address 01

0FH: AC drive of address 15

10H: AC drive of address 16

:

FEH: AC drive of address 254

3.3 Function (Function code) and DATA (data characters)

The format of data characters depends on the function code.

(1) 03H: read data from register

Example: reading continuous 2 data from register address 2102H, AMD address is 01H.

ASCII mode:

| Command Message: | | Response Message: | |
|-----------------------------------|-----|--------------------------------------|-----|
| STX | '.' | STX | '.' |
| Address | '0' | Address | '0' |
| | '1' | | '1' |
| Function | '0' | Function | '0' |
| | '3' | | '3' |
| Starting address | '2' | Number of data (count by byte) | '0' |
| | '1' | | '4' |
| | '0' | Content of starting address 2102H | '1' |
| | '2' | | '7' |
| Number of data (count by word) | '0' | Content of address 2103H | '7' |
| | '0' | | '0' |
| | '0' | | '0' |
| | '2' | | '0' |
| LRC Check | 'D' | LRC Check | '0' |
| | '7' | | '0' |
| END | CR | END | '7' |
| | LF | | '1' |
| | | | CR |
| | | | LF |

RTU mode:

| Command & Message: | | Response Message: | |
|------------------------------------|-----|-----------------------------------|----------------------------------|
| Address | 01H | Address | 01H |
| Function | 03H | Function | 03H |
| Starting data address | 21H | Number of data (count by byte) | 04H |
| | 02H | | Content of data address 2102H |
| Number of data (count by world) | 00H | | 17H |
| | 02H | Content of data address 2103H | 70H |
| CRC CHK Low | 6FH | | 00H |
| CRC CHK High | F7H | | 00H |
| | | CRC CHK Low | FEH |
| | | CRC CHK High | 5CH |

(2) 06H: single write, write single data to register.

Example: writing data 6000(1770H) to register 0100H. AMD address is 01H.

ASCII mode:

| Command & Message: | | Response Message: | |
|--------------------|-----|-------------------|-----|
| STX | '.' | STX | '.' |
| Address | '0' | Address | '0' |
| | '1' | | '1' |
| Function | '0' | Function | '0' |
| | '6' | | '6' |
| Data address | '0' | Data address | '0' |
| | '1' | | '1' |
| | '0' | | '0' |
| | '0' | | '0' |
| Data content | '1' | Data content | '1' |
| | '7' | | '7' |
| | '7' | | '7' |
| | '0' | | '0' |
| LRC Check | '7' | LRC Check | '7' |
| | '1' | | '1' |
| END | CR | END | CR |
| | LF | | LF |

RTU mode:

| Command & Message: | | Response Message: | |
|--------------------|-----|-------------------|-----|
| Address | 01H | Address | 01H |
| Function | 06H | Function | 06H |
| Data address | 01H | Data address | 01H |
| | 00H | | 00H |
| Data content | 17H | Data content | 17H |
| | 70H | | 70H |
| CRC CHK Low | 86H | CRC CHK Low | 86H |
| CRC CHK High | 22H | CRC CHK High | 22H |

(3) 10H: write multiple registers (write multiple data to registers) (at most 20 sets of data can be written simultaneously)

Example: Set the multi-step speed,

Pr.04-00=50.00 (1388H), Pr.04-01=40.00 (0FA0H). AC drive address is 01H.

ASCII mode

| Command Message: | | Response Message: | |
|---------------------------------------|-----|---------------------------------------|-----|
| STX | ':' | STX | ':' |
| ADR 1 | '0' | ADR 1 | '0' |
| ADR 0 | '1' | ADR 0 | '1' |
| CMD 1 | '1' | CMD 1 | '1' |
| CMD 0 | '0' | CMD 0 | '0' |
| Target Register | '0' | Target Register | '0' |
| | '5' | | '5' |
| | '0' | | '0' |
| | '0' | | '0' |
| Number of Register (Count by word) | '0' | Number of Register (Count by word) | '0' |
| | '0' | | '0' |
| | '0' | | '0' |
| | '2' | | '2' |
| Number of Register (Count by byte) | '0' | LRC Check | 'E' |
| | '4' | | '8' |
| The first data content | '1' | END | CR |
| | '3' | | LF |
| | '8' | | |
| | '8' | | |
| The second data content | '0' | | |
| | 'F' | | |
| | 'A' | | |
| | '0' | | |
| LRC Check | '9' | | |
| | 'A' | | |
| END | CR | | |
| | LF | | |

RTU mode

| Command Message: | | Response: | |
|------------------------------------|-----|------------------------------------|-----|
| ADR | 01H | ADR | 01H |
| CMD | 10H | CMD 1 | 10H |
| Target Register | 05H | Target Register | 05H |
| | 00H | | 00H |
| Number of Register (Count by word) | 00H | Number of Register (Count by word) | 00H |
| | 02H | | 02H |
| Number of Register(Byte) | 04 | CRC Check Low | 41H |
| The first Data content | 13H | CRC Check High | 04H |
| | 88H | | |
| The second Data content | 0FH | | |
| | A0H | | |
| CRC Check Low | '9' | | |
| CRC Check High | 'A' | | |

3.4 Check Sum**ASCII mode (LRC Check)**

LRC (Longitudinal Redundancy Check) is calculated by summing up the values of the bytes from ADR1 to the last data character then calculating the hexadecimal representation of the 2's-complement negation of the sum.

For example,

$01H+03H+21H+02H+00H+02H=29H$, the 2's-complement negation of 29H is **D7H**.

RTU mode (CRC check)

CRC (Cyclical Redundancy Check) is calculated by the following steps:

Step 1: Load a 16-bit register (called CRC register) with FFFFH.

Step 2: Exclusive OR the first 8-bit byte of the command message with the low order byte of the 16-bit CRC register, putting the result in the CRC register.

Step 3: Examine the LSB of CRC register.

Step 4: If the LSB of CRC register is 0, shift the CRC register one bit to the right with MSB zero filling, then repeat step 3. If the LSB of CRC register is 1, shift the CRC register one bit to the right with MSB zero filling, Exclusive OR the CRC register with the polynomial value A001H, then repeat step 3.

Step 5: Repeat step 3 and 4 until eight shifts have been performed. When this is done, a complete 8-bit byte will have been processed.

Step 6: Repeat step 2 to 5 for the next 8-bit byte of the command message. Continue doing this until all bytes have been processed. The final contents of the CRC register are the CRC value. When transmitting the CRC value in the message, the upper and lower bytes of the CRC value must be swapped, i.e. the lower order byte will be transmitted first.

The following is an example of CRC generation using C language. The function takes two arguments:

```
unsigned char* data    ← // a pointer to the message buffer
unsigned char length  ← // the quantity of bytes in the message buffer
unsigned int crc_chk(unsigned char* data, unsigned char length)
{
    int j;
    unsigned int reg_crc=0xffff;
    while(length--){
        reg_crc ^= *data++;
        for(j=0;j<8;j++){
            if(reg_crc & 0x01){ /* LSB(b0)=1 */
                reg_crc=(reg_crc>>1) ^ 0xa001;
            }else{
                reg_crc=reg_crc >>1;
            }
        }
    }
}

return reg_crc;                // return register to CRC
```

3.5 Address List

The contents of available addresses are shown as below:

| Content | Address | Function | |
|--------------------------|------------------------------------------------------------|---------------------------------------------------------------------------------------------------------------------------------------------------------------------------------------------------------------------------------------------------------|----------------------------------------------------------------------------------------------|
| AC drive Parameters | GGnnH | GG means parameter group, nn means parameter number, for example, the address of Pr 4-01 is 0401H. Referencing to chapter 5 for the function of each parameter. When reading parameter by command code 03H, only one parameter can be read at one time. | |
| Command Write only | 2000H | Bit 0-3 | 0: No function 1: Stop 2: Run 3: Jog + Run |
| Status monitor Read only | 2001H | Bit 4-5 | 00B: No function 01B: FWD 10B: REV 11B: Change direction |
| | | Bit 6-7 | 00B: 1st accel/decel 01B: 2nd accel/decel 10B: 3rd accel/decel 11B: 4th accel/decel |
| | | Bit 8-11 | Represented 16 step speeds. |
| | | Bit 12 | 1: Enable bit 06-11 |
| | | Bit 13~14 | 00B: No function |
| | | | 01B: operated by digital keypad |
| | | | 02B: operated by Pr.00-15 setting |
| | Bit 15 | Reserved | |
| | 2002H | Frequency command | |
| | 2002H | Bit 0 | 1: EF (external fault) on |
| | | Bit 1 | 1: Reset |
| | | Bit 2 | 1: B.B. ON |
| | | Bit 3-15 | Reserved |
| | 2100H | Fault code: refer to Pr.06-16 to Pr.06-21 | |
| | 2119H | Bit 0-Bit 1 | 00: Stop |
| | | | 01: deceleration |
| | | | 10: Ready for operation |
| | | | 11: operation |
| | | Bit 2 | 1:JOG command |
| | | Bit 3-Bit 4 | 00: FWD command, FWD output |
| | | | 01: FWD command, REV output |
| | | | 10: REV command, FWD output |
| | | | 11: Reserved |
| Bit 5 | | Reserved | |
| Bit 6 | | Reserved | |
| Bit 7 | | Reserved | |
| Bit 8 | | 1: Master frequency Controlled by communication interface | |
| Bit 9 | | 1: Master frequency controlled by analog/external terminals signal | |
| Bit 10 | 1: Operation command controlled by communication interface | | |
| Bit 11 | 1: Parameters have been locked | | |
| Bit 12 | 1: enable to copy parameter from keypad | | |
| Bit 13-15 | Reserved | | |
| 2102H | Frequency command (F) | | |
| 2103H | Output frequency (H) | | |
| 2104H | Output current (Axxx.X) | | |
| 2105H | DC-BUS Voltage (Uxxx.X) | | |
| 2106H | Output voltage (Exxx.X) | | |
| 2107H | Current step number of Multi-Step Speed Operation | | |
| 2116H | Multi-function display (Pr.00-04) | | |
| 2201H | Pr.00-05 user-defined setting | | |
| 2203H | AUI1 analog input (xxx.xx %) | | |
| 2204H | ACI analog input (xxx.xx %) | | |

| Content | Address | Function |
|---------|---------|----------------------------------------------------------------------|
| | 2205H | AUI2 analog input (XXX.XX %) |
| | 2206H | Display temperature of IGBT (°C) |
| | 2207H | Display temperature of heatsink (°C) (only for model 40HP and above) |
| | 2208H | Digital input state |
| | 2209H | Digital output state |

3.6 Exception Response

The AC motor drive is expected to return a normal response after receiving command messages from the master device. The following depicts the conditions when no normal response is replied to the master device.

The AC motor drive does not receive the messages due to a communication error; thus, the AC motor drive has no response. The master device will eventually process a timeout condition.

The AC motor drive receives the messages without a communication error, but cannot handle them. An exception response will be returned to the master device and an error message “CExx” will be displayed on the keypad of AC motor drive. The xx of “CExx” is a decimal code equal to the exception code that is described below.

In the exception response, the most significant bit (bit7) of the original command code is set to 1 (function code and 80H), and an exception code which explains the condition that caused the exception is returned.

Example:

| ASCII mode: | | RTU mode | |
|----------------|-----|----------------|-----|
| STX | ‘.’ | Address | 01H |
| Address | ‘0’ | Function | 86H |
| | ‘1’ | Exception code | 02H |
| Function | ‘8’ | CRC CHK Low | C3H |
| | ‘6’ | CRC CHK High | A1H |
| Exception code | ‘0’ | | |
| | ‘2’ | | |
| LRC CHK | ‘7’ | | |
| | ‘7’ | | |
| END | CR | | |
| | LF | | |

Description of Exception Codes:

| Exception Code | Description |
|----------------|----------------------------------------------------------------------------------------------------------------------------------------------------------------------------------------------------------------|
| 1 | Illegal function code: The function code received in the command message is not available for the AC motor drive. |
| 2 | Illegal data address: The data address received in the command message is not available for the AC motor drive. |
| 3 | Illegal data value: The data value received in the command message is not available for the AC drive. |
| 4 | Slave device failure: The AC motor drive is unable to perform the requested action. |
| 10 | Communication time-out: If Pr.09-03 is not equal to 0.0, Pr.09-02=0~1, and there is no communication on the bus during the Time Out detection period (set by Pr.09-03), “cE10” will be shown on the keypad. |

↗ **09-05** Response Delay Time

Control Mode **VF VFPG SVC FOCPG TQCPG FOCPM** Factory Setting:2.0
 Settings 0.0~200.0ms

📖 In case if the host computer didn't finish the transmitting/receiving process, this parameter is the response delay time after AC drive receives communication command as shown in the following.

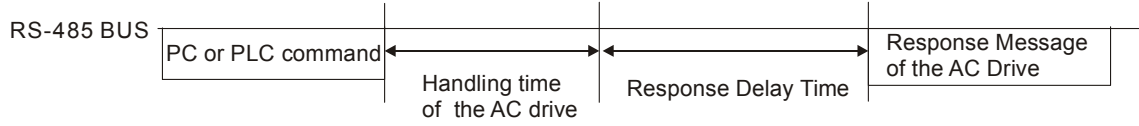

↗ **09-06** Direct docking mode only ◆

~
09-13

Control Mode **VF VFPG SVC FOCPG FOCPM** Factory Setting:
 Settings Contact Delta for more information

10 Speed Feedback Control Parameters

In this parameter group, ASR is the abbreviation for Adjust Speed Regulator and PG is the abbreviation for Pulse Generator.

10-00

Selection of Encoder

Control Mode **VFPG** **FOCPG TQCPG FOCPM** Factory Setting: 0

Settings 0: Disable
 1: ABZ
 2: ABZ+Hall
 3: SIN/COS + Sinusoidal
 4: SIN/COS + Endat
 5: SIN/COS
 6: SIN/COS + Hiperface

When Pr.10-00 is set to 3, encoder will have one sine and one cosine signal for each revolution. The signal must be: 0.75 to 1.2Vpp for the amplitude with phase angle $90^{\circ} \pm 5$ elec. (EX: ERN 1185 ERN 1387)

When setting is 4 or 6, it needs to wait for 2 seconds after applying the power to execute RUN command.

Detection of the magnetic pole:

Setting 1 or 5: The AC motor drive will output short circuit to detect the position of the magnetic pole. At this moment, the motor will generate a little noise.

Setting 2: The AC motor drive will detect the position of the magnetic pole by the UVW signal of encoder.

Setting 3: The AC motor drive will detect the position of the magnetic pole by the sine signal of encoder.

Setting 4 or 6: The AC motor drive will detect the position of the magnetic pole by the communication signal of encoder.

Reference table for tuning

| Setting of PG signal type | PG signal type | Applicable PG card | Pr.08-00=1 | Pr.08-00=3 |
|---------------------------|---------------------|--------------------|----------------------------|----------------------------|
| 10-00=1 | A, B, Z | EMED-PGAB/ABD-1 | N/A | N/A |
| 10-00=2 | A, B, Z+U, V, W | EMED-PGABD-1 | Rolling test* ¹ | Rolling test* ¹ |
| 10-00=3 | SIN/COS+ Sinusoidal | EMED-PGHSD-1 | Rolling test* ¹ | Rolling test* ¹ |
| 10-00=4 | SIN/COS+Endat | EMED-PGSD-1 | Dynamic test* ¹ | Static test* ¹ |
| 10-00=5 | SIN/COS | EMED-PGHSD-1 | N/A | N/A |
| 10-00=6 | SIN/COS + Hiperface | EMED-PGHSD-1 | Dynamic test* ¹ | Static test* ¹ |

*1 Static: Brake engaged, no motor running/ Dynamic: Brake released, motor rotates less than one round/ Rolling: Brake released, motor rotates more than one round.

10-01



Encoder Pulse

Control Mode **VFPG** **FOCPG TQCPG FOCPM** Factory Setting:2048

Settings 1~25000

A Pulse Generator (PG) or encoder is used as a sensor that provides a feedback signal of the motor speed. This parameter defines the number of pulses for each cycle of the PG control.

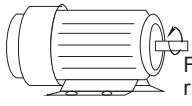
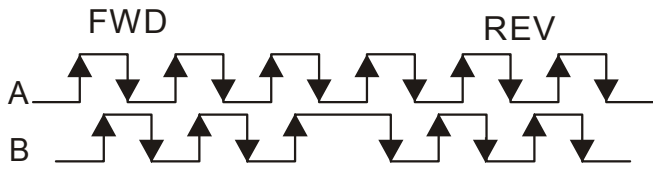
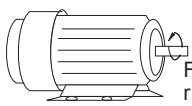
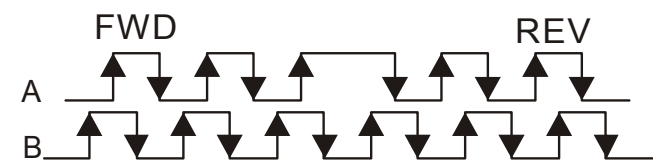
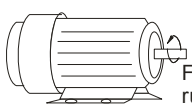
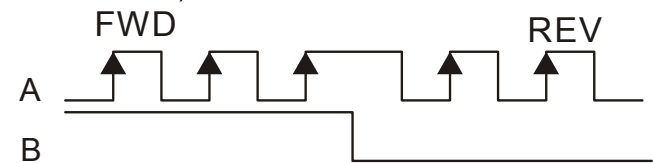
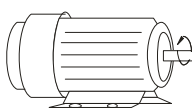
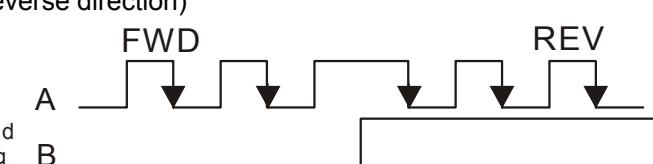
10-02 Encoder Input Type Setting

| Control Mode | VFPG | FOCPG | TQCPG | FOCPM | Factory Setting: 0 |
|--------------|------|-------------------------------------------------------------------------------------|--------------------------------------------------------------------------------------|-------|------------------------------------------------------------------------------------------------------------------------|
| Settings | 0 | Disable | | | Phase A leads in a forward run command and phase B leads in a reverse run command |
| | 1 |  |  | | Phase B leads in a forward run command and phase A leads in a reverse run command |
| | 2 |  |  | | Phase A is a pulse input and phase B is a direction input. (low input=reverse direction, high input=forward direction) |
| | 3 |  |  | | Phase A is a pulse input and phase B is a direction input. (low input=forward direction, high input=reverse direction) |
| | 4 |  |  | | Single-phase input |
| | 5 |  |  | | |

 It is helpful for the stable control by inputting correct pulse type.

 When Pr10-00 is set as 3, 4, 5 or 6, Pr10-02 can only be set as 0, 1 or 2, while 3, 4 and 5 cannot be chosen.

10-03 Encoder Feedback Fault Treatment (PGF1, PGF2)

| Control Mode | VFPG | FOCPG | TQCPG | FOCPM | Factory Setting:2 |
|--------------|-----------------------------|-------|-------|-------|-------------------|
| Settings | 0: Warn and keep operation | | | | |
| | 1: Fault and RAMP to stop | | | | |
| | 2: Fault and stop operation | | | | |

10-04 Detection Time for Encoder Feedback Fault

| Control Mode | VFPG | FOCPG | TQCPG | FOCPM | Factory Setting:1.0 |
|--------------|-------------|-------|-------|-------|---------------------|
| Settings | 0.0~10.0sec | | | | |

 When PG loss, encoder signal error, pulse signal setting error or signal error, if time exceeds the detection time for encoder feedback fault (Pr.10-04), the PG signal error will occur. Refer to the Pr.10-03 for encoder feedback fault treatment.

➤ **10-05** Encoder Stall Level (PGF3)

| | | | | | |
|--------------|-------------|------------|--------------|--------------|---------------------|
| Control Mode | VFPG | SVC | FOCPG | FOCPM | Factory Setting:115 |
| Settings | 0~120% | | | | |
| | 0: Disable | | | | |

📖 This parameter determines the maximum encoder feedback signal allowed before a fault occurs. (max. output frequency Pr.01-00 =100%)

➤ **10-06** Encoder Stall Detection Time (maximum output frequency 01-00=100%)

| | | | | | |
|--------------|-------------|------------|--------------|--------------|---------------------|
| Control Mode | VFPG | SVC | FOCPG | FOCPM | Factory Setting:0.1 |
| Settings | 0.0~2.0sec | | | | |

➤ **10-07** Encoder Slip Range (PGF4) (maximum output frequency 01-00=100%)

| | | | | | |
|--------------|-------------|------------|--------------|--------------|--------------------|
| Control Mode | VFPG | SVC | FOCPG | FOCPM | Factory Setting:50 |
| Settings | 0~50% | | | | |
| | 0: Disable | | | | |

➤ **10-08** Encoder Slip Detection Time (maximum output frequency 01-00=100%)

| | | | | | |
|--------------|-------------|------------|--------------|--------------|---------------------|
| Control Mode | VFPG | SVC | FOCPG | FOCPM | Factory Setting:0.5 |
| Settings | 0.0~10.0sec | | | | |

➤ **10-09** Encoder Stall and Slip Error Treatment (maximum output frequency 01-00=100%)

| | | | | | |
|--------------|----------------------------|------------|--------------|--------------|-------------------|
| Control Mode | VFPG | SVC | FOCPG | FOCPM | Factory Setting:2 |
| Settings | 0: Warn and keep operating | | | | |
| | 1: Fault and RAMP to stop | | | | |
| | 2: Fault and COAST to stop | | | | |

📖 When the value of (rotation speed – motor frequency) exceeds Pr.10-07 setting, detection time exceeds Pr.10-08 or motor frequency exceeds Pr.10-05 setting, it will start to accumulate time. If detection time exceeds Pr.10-06, the encoder feedback signal error will occur. Refer to Pr.10-09 encoder stall and slip error treatment.



10-10 Mode Selection for UVW Input

| | | | | | |
|--------------|-----------------------------------------------|--------------|--------------|--------------|--------------------|
| Control Mode | VFPG | FOCPG | TQCPG | FOCPM | Factory Setting: 0 |
| Settings | 0: Z signal is at the falling edge of U-phase | | | | |
| | 1: Z signal is at the rising edge of U-phase | | | | |

📖 Setting 0: when the operation is U->V->W, Z signal is at the falling edge of U-phase.
Setting 1: when the operation is U->V->W, Z signal is at the rising edge of U-phase.

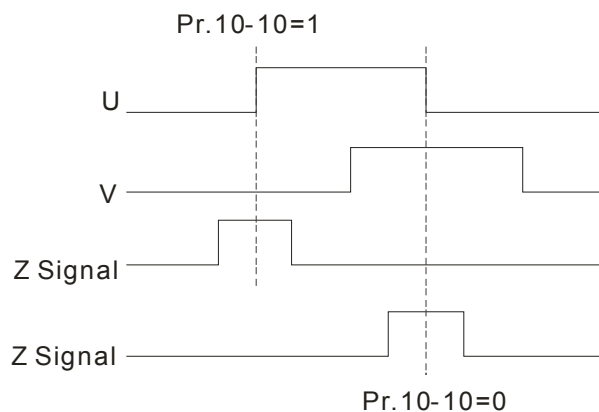

| | |
|----------------|----------------------------------------------------------------------------------|
| ↗ 10-11 | ASR (Auto Speed Regulation) Control (P) of Zero Speed |
| Control Mode | VF VFPG SVC FOCPG FOCPM Factory Setting:100.0 |
| Settings | 0.0~1000.0% |
| ↗ 10-12 | ASR (Auto Speed Regulation) Control (I) of Zero Speed |
| Control Mode | VF VFPG SVC FOCPG FOCPM Factory Setting:0.100 |
| Settings | 0.000~10.000sec |
| ↗ 10-13 | ASR (Auto Speed Regulation) control (P) 1 |
| Control Mode | VF VFPG SVC FOCPG FOCPM Factory Setting:100.0 |
| Settings | 0.0~1000.0% |
| ↗ 10-14 | ASR (Auto Speed Regulation) control (I) 1 |
| Control Mode | VF VFPG SVC FOCPG FOCPM Factory Setting:0.100 |
| Settings | 0.000~10.000sec |
| ↗ 10-15 | ASR (Auto Speed Regulation) control (P) 2 |
| Control Mode | VF VFPG SVC FOCPG FOCPM Factory Setting:100.0 |
| Settings | 0.0~1000.0% |
| ↗ 10-16 | ASR (Auto Speed Regulation) control (I) 2 |
| Control Mode | VF VFPG SVC FOCPG FOCPM Factory Setting:0.100 |
| Settings | 0.000~10.000sec |
| ↗ 10-17 | ASR 1/ASR2 Switch Frequency |
| Control Mode | VF VFPG SVC FOCPG FOCPM Factory Setting:7.00 |
| Settings | 0.00~400.00Hz 0: Disable |

📖 ASR P determines Proportional control and associated gain (P). ASR I determines integral control and associated gain (I).

📖 When integral time is set to 0, it is disabled. Pr.10-17 defines the switch frequency for the ASR1 (Pr.10-13, Pr.10-14) and ASR2 (Pr.10-15, Pr.10-16).

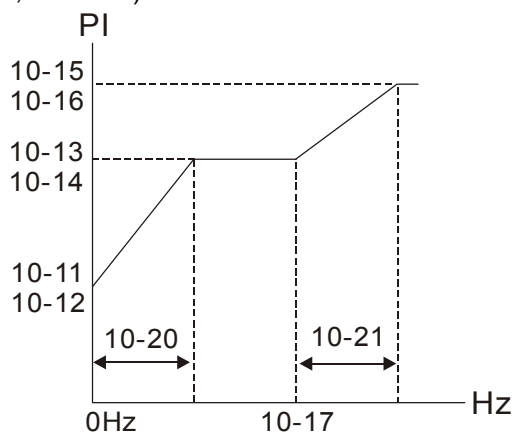

📖 When using multi-function input terminals to switch ASR1/ASR2, the diagram will be shown as follows.

Setting multi-function input terminal to 17
(ASR1/ASR2 switch)

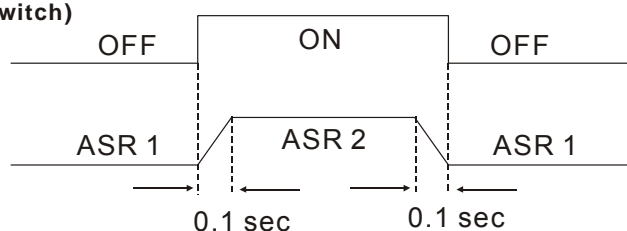

| | | |
|--------------|--------------------------|------------------------------------|
| ↗ | 10-18 | ASR Primary Low Pass Filter Gain |
| Control Mode | VF VFPG SVC FOCPG | FOCPM Factory Setting:0.008 |
| Settings | 0.000~0.350sec | |

- It defines the filter time of the ASR command.
- When setting to 1, this function is disabled.

| | | |
|--------------|--------------|------------------------------------|
| ↗ | 10-19 | Zero Speed Gain (P) |
| Control Mode | | FOCPM Factory Setting:80.00 |
| Settings | 0~655.00% | |

- When Pr.11-00 is set to Bit 7=1, Pr.10-19 is valid

| | | |
|--------------|-------------------|-----------------------------------|
| ↗ | 10-20 | Zero Speed/ASR1 Width Adjustment |
| Control Mode | VFPG FOCPG | FOCPM Factory Setting:5.00 |
| Settings | 0.00~400.00Hz | |

| | | |
|--------------|-------------------|-----------------------------------|
| ↗ | 10-21 | ASR1/ASR2 Width Adjustment |
| Control Mode | VFPG FOCPG | FOCPM Factory Setting:5.00 |
| Settings | 0.00~400.00Hz | |

- These two parameters are used to decide width of slope of ASR command during zero speed to low speed or Pr.10-17 to high speed.

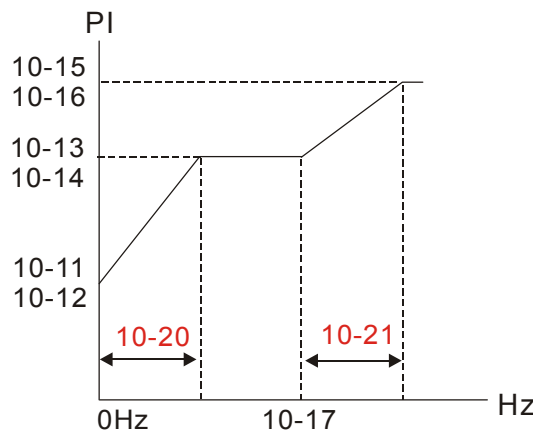

| | | |
|--------------|------------------|------------------------------------|
| ↗ | 10-22 | Zero Speed Position Holding Time |
| Control Mode | | FOCPM Factory Setting:0.250 |
| Settings | 0.001~65.535 sec | |

| | | |
|--------------|------------------|------------------------------------|
| ↗ | 10-23 | Filter Time at Zero Speed |
| Control Mode | | FOCPM Factory Setting:0.004 |
| Settings | 0.001~65.535 sec | |

| | | |
|--------------|-------------------------------------------------------------------------------------------------------------|---------------------------------|
| ↗ | 10-24 | Time for Executing Zero Speed |
| Control Mode | | FOCPM Factory Setting: 0 |
| Settings | 0: After the brake release set in Pr.02-29 1: After the brake signal input (Pr.02-01~02-08 is set to 42) | |

- When Pr.10-24=0, the zero speed control needs to be used with Pr.02-29. (refer to the explanations in Pr.02-32)

| | | |
|--------------|--------------------------|---------------------------------------|
| ↗ | 10-25 | Elevator Leveling (Zero Speed Gain P) |
| Control Mode | VF VFPG SVC FOCPG | FOCPM Factory Setting:100.0 |
| Settings | 0~1000.0% | |

| | | |
|--------------|---------------------------|-------------------------------------------|
| ↗ | 10-26 | Elevator Leveling (Zero Speed Integral I) |
| Control Mode | VF VFPG SVC FOC PG | FOCPM Factory Setting:0.100 |
| Settings | 0.000~10.000sec. | |

| | | |
|--------------|---------------------------|---------------------------------------|
| ↗ | 10-27 | Elevator Starting (Zero Speed Gain P) |
| Control Mode | VF VFPG SVC FOC PG | FOCPM Factory Setting:100.0 |
| Settings | 0.0~1000.0% | |

| | | |
|--------------|---------------------------|-------------------------------------------|
| ↗ | 10-28 | Elevator Starting (Zero Speed Integral I) |
| Control Mode | VF VFPG SVC FOC PG | FOCPM Factory Setting:0.100 |
| Settings | 0.000~10.000sec. | |

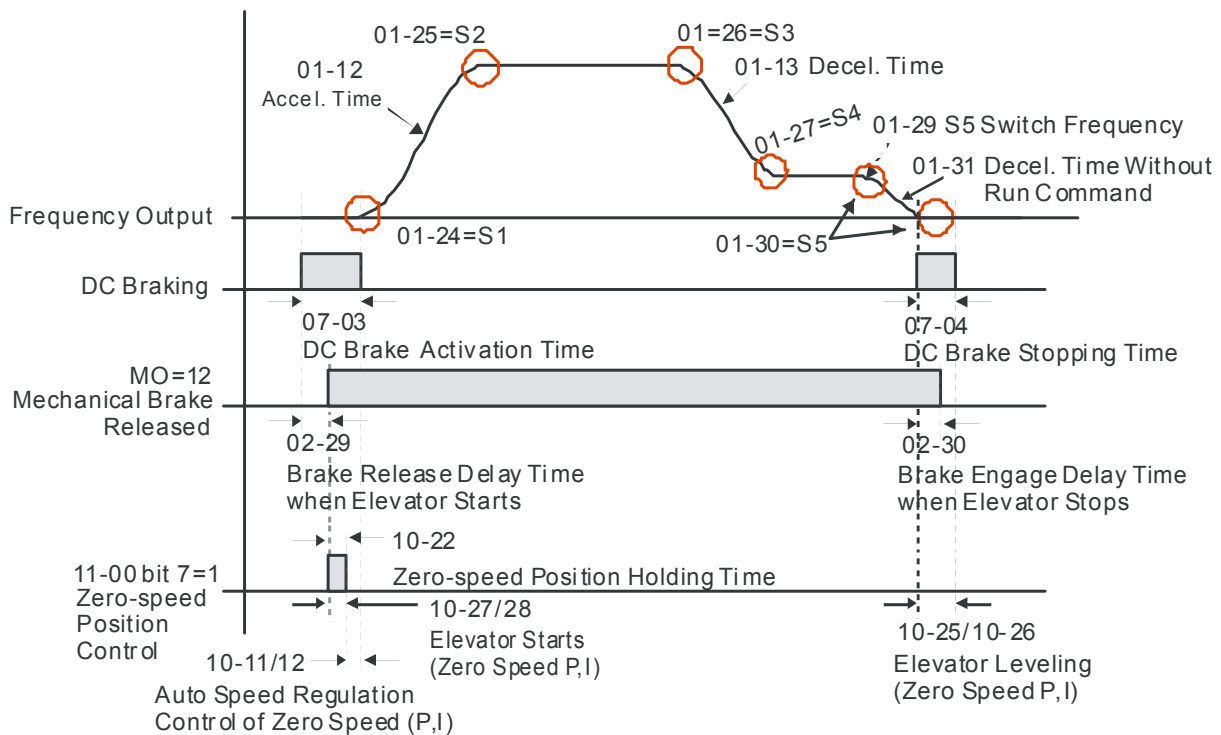

| | | |
|--------------|--------------------|----------------------------------------------|
| ↗ | 10-29 | Setting of PG card frequency division output |
| Control Mode | VFPG FOC PG | FOCPM Factory Setting: 0 |
| Settings | 0~31 | |

| | | |
|--------------|--------------------|-------------------------------------------|
| ↗ | 10-30 | Type of PG card frequency division output |
| Control Mode | VFPG FOC PG | FOCPM Factory Setting: 0000h |
| Settings | 0000h~0008h | |

See CH07 for more information about PG card.

| | | |
|--------------|--------------------|-------------------------------------------|
| ↗ | 10-31 | Type of PG card frequency division output |
| Control Mode | VFPG FOC PG | FOCPM Factory Setting: 0000h |
| Settings | 0000h~0008h | |

When using Heidenhain ERN1387 encoder, adjust the definition of Delta PG card EMED-PGHSD-1's terminal 10 and terminal 11 by through Pr10-31.

📖 Delta PG card: EMED-PGHSD-1 (D-sub Terminal #)

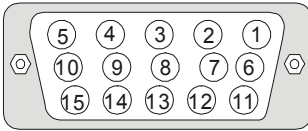

| Heidenhain ERN1387 | | |
|--------------------|-------------|------------|
| Terminal # | 10-31=0000h | 10-31=0001 |
| 10 | C- | C+ |
| 11 | C+ | C- |

11 Advanced Parameters

11-00

System Control

Control Mode

FOCPG

FOCPM

Factory Setting: 0

Settings

Bit 0=0: No function

Bit 0=1: ASR Auto tuning, PDFF enable

Bit 7=0: No function

Bit 7=1: When position control is enabled, it doesn't need to set Pr.07-02 (DC Brake Current Level)

Bit 9=0: Rolling PG Origin auto-tuning with load (support by PGHSD-1)

Bit 9=1: Static PG Origin auto-tuning with load by enabling PGHSD-1

Bit 15=0: When power is applied, it will detect the position of magnetic pole again

Bit 15=1: when power is applied, it will start from the magnetic pole position of previous power failure

 Bit 0=1: PDFF function is enabled and system will generate an ASR setting, Pr. 10-11~10-16 will be invalid and Pr.11-09 to 11-10 will be valid.

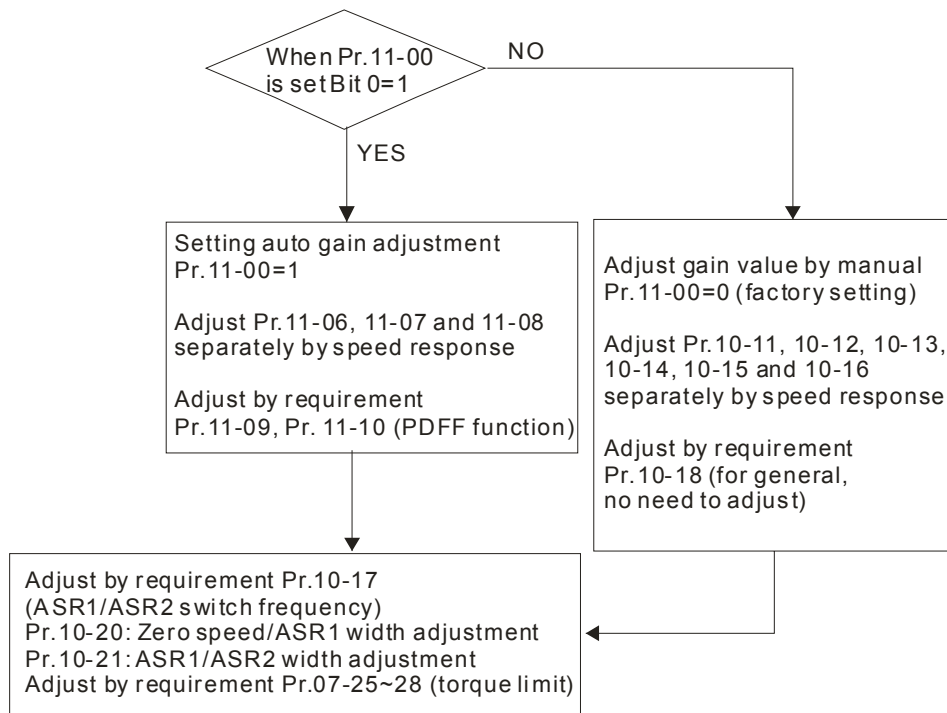

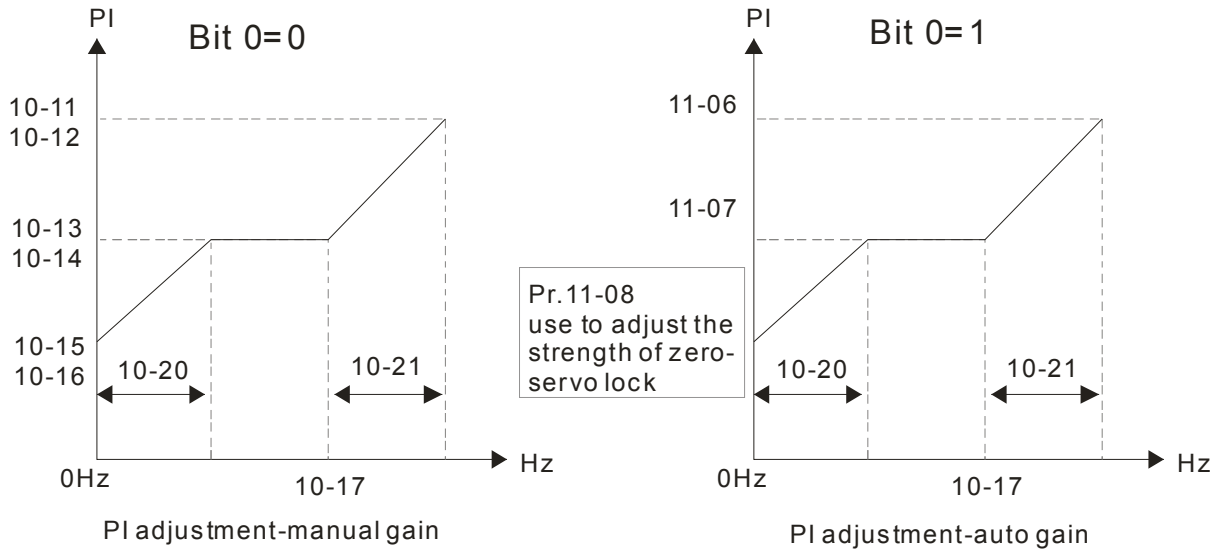

➤ **11-01** Elevator Speed

| | | | |
|--------------|---------------|--------------|----------------------|
| Control Mode | FOCPG | FOCPM | Factory Setting:1.00 |
| Settings | 0.10~4.00 m/s | | |

➤ **11-02** Sheave Diameter

| | | | |
|--------------|--------------|--------------|---------------------|
| Control Mode | FOCPG | FOCPM | Factory Setting:400 |
| Settings | 100~2000 mm | | |

➤ **11-03** Mechanical Gear Ratio

| | | | |
|--------------|--------------|--------------|-------------------|
| Control Mode | FOCPG | FOCPM | Factory Setting:1 |
| Settings | 1~100 | | |

11-04 Suspension Ratio

| | | | |
|--------------|----------------------|--------------|-------------------|
| Control Mode | FOCPG | FOCPM | Factory Setting:1 |
| Settings | 0= 1 : 1 1= 2 : 1 | | |

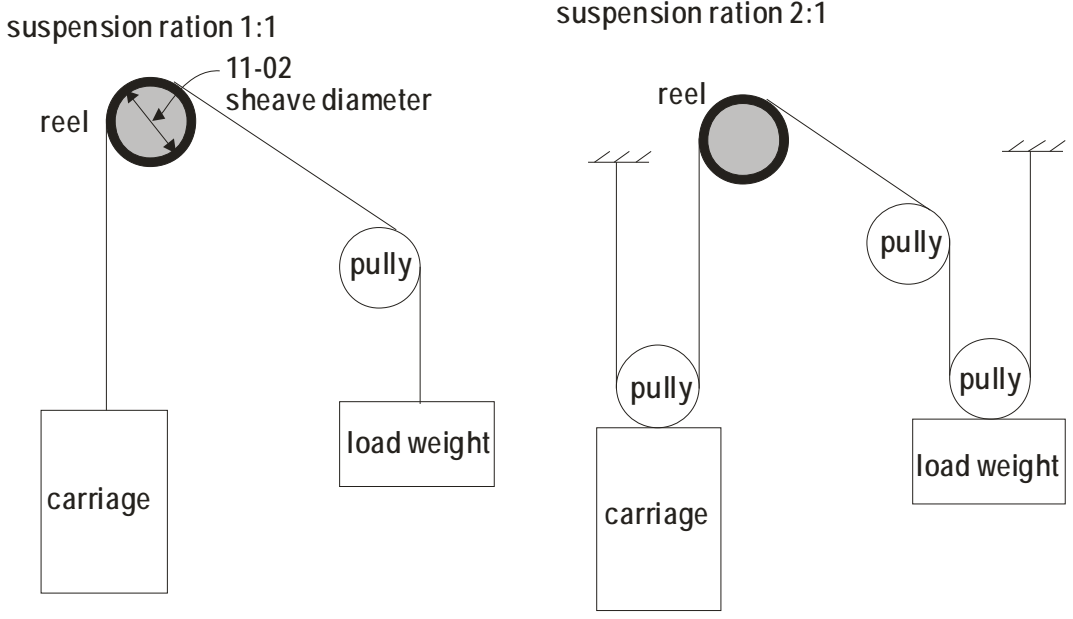

➤ **11-05** Inertial Ratio
 Control Mode **FOCPG** **FOCPM** Factory Setting:40
 Settings 1~300%

📖 The load inertia can be calculated by the settings of motor parameter, Pr.11-02 Sheave Diameter, Pr.11-14 Motor Current at Accel. and Pr.11-15 Elevator Acceleration. This parameter can be used to adjust inertia ratio of load.

➤ **11-06** Zero-speed Bandwidth
 Control Mode **FOCPG** **FOCPM** Factory Setting:10
 Settings 1~40Hz

➤ **11-07** Low-speed Bandwidth
 Control Mode **FOCPG** **FOCPM** Factory Setting:10
 Settings 1~40Hz

➤ **11-08** High-speed Bandwidth
 Control Mode **FOCPG** **FOCPM** Factory Setting:10
 Settings 1~40Hz

📖 After estimating inertia and set Pr.11-00=1 (auto tuning), user can adjust parameters Pr.11-06, 11-07 and 11-08 separately by speed response. The larger number you set, the faster response you will get. Pr.10-08 is the switch frequency for low-speed/high-speed bandwidth.

➤ **11-09** PDFF Gain Value
 Control Mode **FOCPG** **FOCPM** Factory Setting:30
 Settings 0~200%

📖 After finishing estimating and set Pr.11-00=1 (auto tuning), using Pr.11-09/11-10 to reduce overshoot. Please adjust PDFF gain value by actual situation.

📖 Besides traditional PI control, it also provides PDFF function to reduce overshoot for speed control.

1. Get system inertia
2. Set Pr.11-00 to 1
3. Adjust Pr.11-09/11-10 (the larger number is set and the suppressed overshoot function will be better. But it needs to be used by the actual condition)

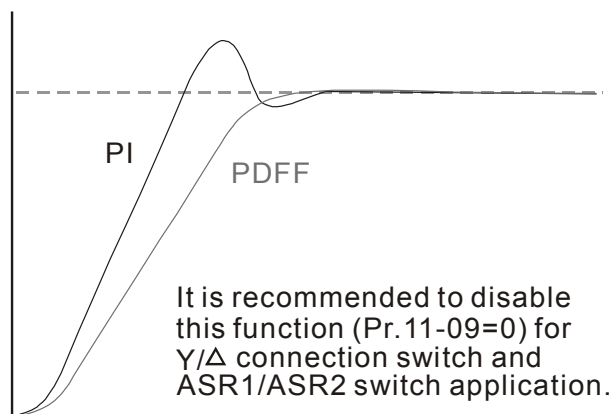

➤ **11-10** Gain for Speed Feed Forward
 Control Mode **FOCPG** **FOCPM** Factory Setting: 0
 Settings 0~500

📖 Pr.11-09 and Pr.11-10 will be enabled when Pr.11-00 is set to Bit0=1.

| | | | | | | | |
|---|--------------|------------------------------------------------------------------------------------------------------------------------------------------------------------------------------------------------------------------------------------------------------------------------------------------------------------------------------------|--------------|--------------|--------------|--------------|----------------------|
| ↗ | 11-11 | Notch Filter Depth | | | | | |
| | Control Mode | | FOCPG | FOCPM | | | Factory Setting: 0 |
| | Settings | 0~20db | | | | | |
| ↗ | 11-12 | Notch Filter Frequency | | | | | |
| | Control Mode | | FOCPG | FOCPM | | | Factory Setting:0.00 |
| | Settings | 0.00~200.00Hz | | | | | |
| | | <p>📖 This parameter is used to set resonance frequency of mechanical system. It can be used to suppress the resonance of mechanical system.</p> <p>📖 The larger number you set Pr.11-11, the better suppression resonance function you will get.</p> <p>📖 The notch filter frequency is the resonance of mechanical frequency.</p> | | | | | |
| ↗ | 11-13 | Low-pass Filter Time of Keypad Display | | | | | |
| | Control Mode | VF | VFP | SVC | FOCPG | TQCPG | FOCPM |
| | Settings | 0.001~65.535 sec | | | | | |
| | | 📖 It is used to lower the blinking frequency of LCD display. | | | | | |
| ↗ | 11-14 | Motor Current at Accel. | | | | | |
| | Control Mode | | | | FOCPM | | Factory Setting:150 |
| | Settings | 50~200% | | | | | |
| | 11-15 | Elevator Acceleration | | | | | |
| | Control Mode | | | | FOCPM | | Factory Setting:0.75 |
| | Settings | 0.20~2.00m/s ² | | | | | |
| ↗ | 11-16 | Reserved | | | | | |
| | Control Mode | VF | VFP | SVC | FOCPG | TQCPG | FOCPM |
| | Settings | 0000h~FFFFh | | | | | |
| ↗ | 11-17 | Reserved | | | | | |
| | Control Mode | VF | VFP | SVC | FOCPG | TQCPG | FOCPM |
| | Settings | Read Only | | | | | |
| ↗ | 11-18 | Reserved | | | | | |
| | Control Mode | VF | VFP | SVC | FOCPG | TQCPG | FOCPM |
| | Settings | 0000h~FFFFh | | | | | |
| ↗ | 11-19 | Zero-speed Holding Bandwidth | | | | | |
| | Control Mode | | FOCPG | FOCPM | | | Factory Setting:10 |
| | Settings | 1~40Hz | | | | | |

12 User-defined Parameters

| | | | | | | | | | | |
|---|--------------|----------------------------------------------|--------------|-----------|-------------|------------|--------------|--------------|--------------|------------------------|
| ↗ | 12-00 | Present Fault Record | Control Mode | VF | VFPG | SVC | FOCPG | TQCPG | FOCPM | Factory Setting: ### |
| | | | Settings | 0616 | | | | | | |
| ↗ | 12-01 | Present Fault Time of Motor Operation (min.) | Control Mode | VF | VFPG | SVC | FOCPG | TQCPG | FOCPM | Factory Setting: #. ## |
| | | | Settings | 0632 | | | | | | |
| ↗ | 12-02 | Present Fault Time of Motor Operation (day) | Control Mode | VF | VFPG | SVC | FOCPG | TQCPG | FOCPM | Factory Setting: #. ## |
| | | | Settings | 0633 | | | | | | |
| ↗ | 12-03 | Frequency Command at Present Fault | Control Mode | VF | VFPG | SVC | FOCPG | TQCPG | FOCPM | Factory Setting: #. ## |
| | | | Settings | 0653 | | | | | | |
| ↗ | 12-04 | Output Frequency at Preset Fault | Control Mode | VF | VFPG | SVC | FOCPG | TQCPG | FOCPM | Factory Setting: #. ## |
| | | | Settings | 0654 | | | | | | |
| ↗ | 12-05 | Output Current at Present Fault | Control Mode | VF | VFPG | SVC | FOCPG | TQCPG | FOCPM | Factory Setting: #. ## |
| | | | Settings | 0655 | | | | | | |
| ↗ | 12-06 | Motor Frequency at Present Fault | Control Mode | VF | VFPG | SVC | FOCPG | TQCPG | FOCPM | Factory Setting: #. ## |
| | | | Settings | 0656 | | | | | | |
| ↗ | 12-07 | Output Voltage at Present Fault | Control Mode | VF | VFPG | SVC | FOCPG | TQCPG | FOCPM | Factory Setting: #. ## |
| | | | Settings | 0657 | | | | | | |
| ↗ | 12-08 | DC-Bus Voltage at Present Fault | Control Mode | VF | VFPG | SVC | FOCPG | TQCPG | FOCPM | Factory Setting: #. ## |
| | | | Settings | 0658 | | | | | | |
| ↗ | 12-09 | Output Power at Present Fault | Control Mode | VF | VFPG | SVC | FOCPG | TQCPG | FOCPM | Factory Setting: #. ## |
| | | | Settings | 0659 | | | | | | |

| | | |
|--------------|----------------------------------------|---------------------------------------------------------|
| ↗ | 12-10 | Output Torque at Present Fault |
| Control Mode | VF VFPG SVC FOC PG TQCPG FOC PM | Factory Setting:### |
| Settings | 0660 | |
| ↗ | 12-11 | IGBT Temperature of Power Module at Present Fault |
| Control Mode | VF VFPG SVC FOC PG TQCPG FOC PM | Factory Setting:### |
| Settings | 0661 | |
| ↗ | 12-12 | Multi-function Terminal Input Status at Present Fault |
| Control Mode | VF VFPG SVC FOC PG TQCPG FOC PM | Factory Setting:### |
| Settings | 0662 | |
| ↗ | 12-13 | Multi-function Terminal Output Status at Present Fault |
| Control Mode | VF VFPG SVC FOC PG TQCPG FOC PM | Factory Setting:### |
| Settings | 0663 | |
| ↗ | 12-14 | Drive Status at Present Fault |
| Control Mode | VF VFPG SVC FOC PG TQCPG FOC PM | Factory Setting:### |
| Settings | 0664 | |
| ↗ | 12-15 | Second Most Recent Fault Record |
| Control Mode | VF VFPG SVC FOC PG TQCPG FOC PM | Factory Setting:### |
| Settings | 0617 | |
| ↗ | 12-16 | Second Most Recent Fault Time of Motor Operation (min.) |
| Control Mode | VF VFPG SVC FOC PG TQCPG FOC PM | Factory Setting:### |
| Settings | 0634 | |
| ↗ | 12-17 | Second Most Recent Fault Time of Motor Operation (day) |
| Control Mode | VF VFPG SVC FOC PG TQCPG FOC PM | Factory Setting:### |
| Settings | 0635 | |
| ↗ | 12-18 | Third Most Recent Fault Record |
| Control Mode | VF VFPG SVC FOC PG TQCPG FOC PM | Factory Setting:### |
| Settings | 0618 | |
| ↗ | 12-19 | Third Most Recent Fault Time of Motor Operation (min.) |
| Control Mode | VF VFPG SVC FOC PG TQCPG FOC PM | Factory Setting:### |
| Settings | 0636 | |

| | | | | | | | | | | |
|---|--------------|---------------------------------------------------------|--------------|-----------|-------------|------------|--------------|--------------|--------------|---------------------|
| ↗ | 12-20 | Third Most Recent Fault Time of Motor Operation (day) | Control Mode | VF | VFPG | SVC | FOCPG | TQCPG | FOCPM | Factory Setting:### |
| | | | Settings | 0637 | | | | | | |
| ↗ | 12-21 | Fourth Most Recent Fault Record | Control Mode | VF | VFPG | SVC | FOCPG | TQCPG | FOCPM | Factory Setting:### |
| | | | Settings | 0619 | | | | | | |
| ↗ | 12-22 | Fourth Most Recent Fault Time of Motor Operation (min.) | Control Mode | VF | VFPG | SVC | FOCPG | TQCPG | FOCPM | Factory Setting:### |
| | | | Settings | 0638 | | | | | | |
| ↗ | 12-23 | Fourth Most Recent Fault Time of Motor Operation (min.) | Control Mode | VF | VFPG | SVC | FOCPG | TQCPG | FOCPM | Factory Setting:### |
| | | | Settings | 0639 | | | | | | |
| ↗ | 12-24 | Fifth Most Recent Fault Record | Control Mode | VF | VFPG | SVC | FOCPG | TQCPG | FOCPM | Factory Setting:### |
| | | | Settings | 0620 | | | | | | |
| ↗ | 12-25 | Fifth Most Recent Fault Time of Motor Operation (min.) | Control Mode | VF | VFPG | SVC | FOCPG | TQCPG | FOCPM | Factory Setting:### |
| | | | Settings | 0640 | | | | | | |
| ↗ | 12-26 | Fifth Most Recent Fault Time of Motor Operation (day) | Control Mode | VF | VFPG | SVC | FOCPG | TQCPG | FOCPM | Factory Setting:### |
| | | | Settings | 0641 | | | | | | |
| ↗ | 12-27 | Sixth Most Recent Fault Record | Control Mode | VF | VFPG | SVC | FOCPG | TQCPG | FOCPM | Factory Setting:### |
| | | | Settings | 0621 | | | | | | |
| ↗ | 12-28 | Sixth Most Recent Fault Time of Motor Operation (min.) | Control Mode | VF | VFPG | SVC | FOCPG | TQCPG | FOCPM | Factory Setting:### |
| | | | Settings | 0642 | | | | | | |
| ↗ | 12-29 | Sixth Most Recent Fault Time of Motor Operation (day) | Control Mode | VF | VFPG | SVC | FOCPG | TQCPG | FOCPM | Factory Setting:### |
| | | | Settings | 0643 | | | | | | |

↗ 12-30 No factory setting

↗ 12-31 No factory setting

12-00

~

User-defined Parameters

12-31

Control Mode VF VFPG SVC FOC PG TQCPG FOC PM

Factory Setting:-

Settings -

📖 Users can enter the parameters from group 0 to group 11 into group 12 (it can save 32 parameters). The saved value can also be the parameter addresses (but the hexadecimal value needs to be converted to decimal value).

📖 Example 2: If it needs to enter parameter address 2102H and 211BH by the digital keypad, 211BH needs to be converted to binary value before entering.
The setting method of 2102H

📖 Examples of User-defined parameters

Example 1: If you want to enter Pr.08-03 into Pr.12-00, you only need to enter 0803 into Pr.12-00. Then it will display the setting of Pr.08-03 in Pr.13-00.

Example 2: If it needs to enter parameter address 2102H and 211BH by the digital keypad, 211BH needs to be converted to binary value before entering.

The setting method of 211BH

Convert 211BH (hexadecimal) to decimal value:

$$\begin{array}{c}
 2 \ 1 \ 1 \ B \\
 \swarrow \quad \searrow \\
 1 \times 16^1 + 11 \times 16^0 = 16 + 11 = 27 \quad \text{input } 2127
 \end{array}$$

13 View User Defined Parameters

13-00

~

View User Defined Parameters

13-31

Control Mode **VF** **VFP** **SVC** **FOCPG** **TQCPG** **FOCPM**

Factory Setting:-

Settings -Pr00-00 to Pr11-19

13 Warning Codes

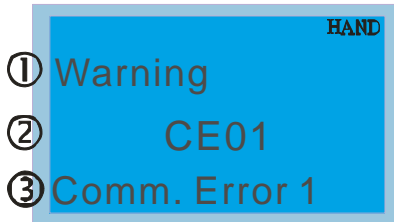

① Warning

② CE01



③ Comm. Error 1



① Display error signal

② Abbreviated error code
The code is displayed as shown on KPC-CE01.

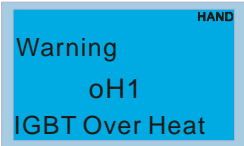
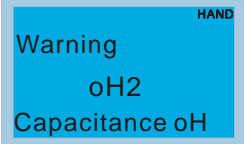
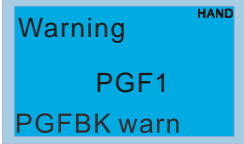
③ Display error description

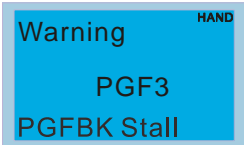
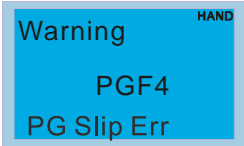
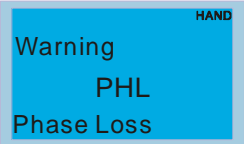
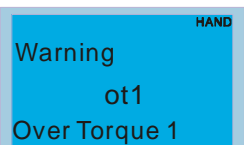
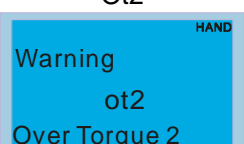
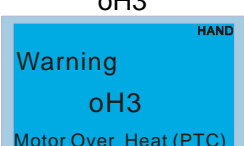
| ID No. | Display on KPE-LE01 | Display on LCM Keypad | Descriptions |
|--------|---------------------|-----------------------|------------------------------------------------------------------------------------------------------------------------------------------------------------------------------------------|
| 1 | CE01 | | Communication command defected Cause Communication error |
| 2 | CE02 | | Address of data defected Cause Communication error |
| 3 | CE03 | | Length of communication data defected Cause Communication error Communication error |
| 4 | CE04 | | Communications being written in a read only address. Cause Communication error |
| 5 | CE10 | | Modbus transmission time-out Cause Communication error |
| 6 | CP10 | | Keypad KPC-CC01 transmission time-out Cause Communication error |
| 7 | SE1 | | Keypad copying parameter error 1 Cause Keypad simulation error, including communication delays, communication error (keypad received error FF86) and parameter value error. |
| 8 | SE2 | | Keypad copying parameter fail error 2 Cause keypad simulation done but parameter write error |

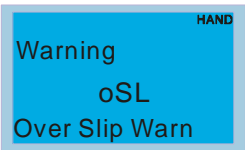
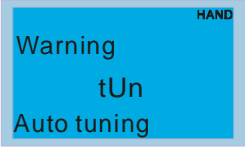
| ID No. | Display on KPE-LE01 | Display on LCM Keypad | Descriptions |
|--------|---------------------|-------------------------------------------------------------------------------------|----------------------------------------------------------------------------------------------------------------------------------------------------------------------------------|
| 9 | oH1 |  | IGBT over-heating warning Cause The temperature of the IGBT are over the factory setting 90°C (Pr06-14). |
| 10 | oH2 |  | Capacitor over-heating warning Cause The temperature of the capacitor is over 65°C. . |
| 15 | P9F1 |  | PG card feedback error Cause When Pr10-03 = 0 (factory setting = 2), a warning message will be displayed instead of a fault message while an error occurs. |
| 16 | P9F2 |  | PG feedback loss warning Cause Pr10-03 = 0 (factory setting = 2), a warning message will be displayed instead of a fault message while an error occurs. |
| 17 | P9F3 |  | PG feedback stall warning Cause Pr10-09 = 0 (factory setting = 2), a warning message will be displayed instead of a fault message while an error occurs. |
| 18 | P9F4 |  | PG slip warning Cause Pr10-09 = 0 (factory setting = 2), a warning message will be displayed instead of a fault message while an error occurs. |
| 19 | PHL |  | Phase loss Cause When Pr06-01 =0 (factory setting = 2), a warning message will be given instead of a fault message while a phase loss occurs. |
| 20 | ot 1 |  | Over torque 1 Cause When Pr06-05 =1 or 3 (factory setting = 2), a warning message will be given instead of a fault message while there is an over torque detection. |
| 21 | ot 2 |  | Over torque 2 Cause When Pr06-05 =1 or 3 (factory setting = 2), a warning message will be given instead of a fault message while there is an over torque detection. |
| 22 | oH3 |  | Motor over-heating (PTC) Cause When Pr06-26 =1 (factory setting = 0), a warning message will be given when there is a PTC detection. |

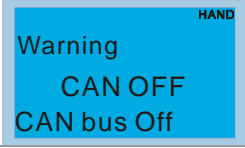
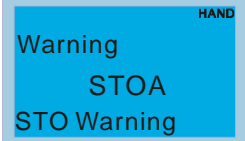
| ID No. | Display on KPE-LE01 | Display on LCM Keypad | Descriptions |
|--------|---------------------|-------------------------------------------------------------------------------------------------|---------------------------------------------------------------------------------------------------------------------------------------------------------------------------------------------------------------------------------------------|
| 24 | oSL | <p>oSL</p>  | <p>Over slip</p> <p>Cause When Pr05-16 =0 (factory setting = 0), a warning message will be given while the slip deviation level is over the setting at Pr05-14 and the detection time is longer than the setting at Pr05-15.</p> |
| 25 | tUn | <p>tUn</p>  | <p>Auto tuning in process</p> |
| 26 | FAn | <p>FAn</p>  | <p>Fan stop turning</p> <p>Cause When Pr06-45 bit 1 =1, a warning message will be given when the cooling fan is locked (when bit1=1, there is an output error).</p> |
| 27 | dCAN | <p>dCAN</p>  | <p>CANbus off</p> <p>Cause Error(s) occurred on CANbus</p> |
| 28 | StOA | <p>StOA</p>  | <p>Safety Torque Off Alarm</p> <p>Cause Safety torque output is off and Pr06-49 =1 or 3.</p> |

14 Fault Codes

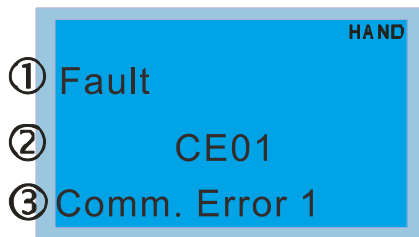

① Display fault (error) signal.



② Abbreviated fault (error) code
The code is displayed as shown on KPC-CC01.

③ Display fault (error) description.

*In accordance with the settings of Pr06-16 ~ Pr06-21.

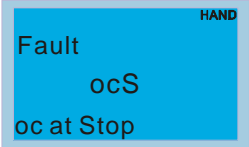
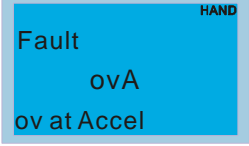
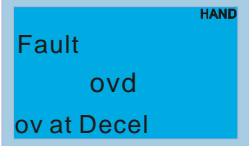
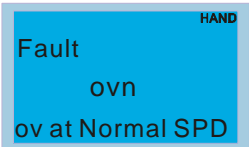
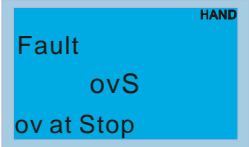
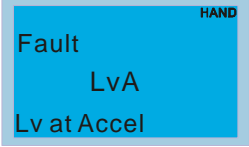
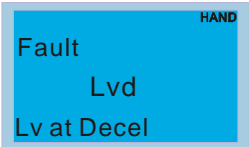

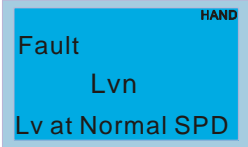
| ID* | Display on KPE-LE01 | LCM Panel Display | Descriptions |
|-----|---------------------|-------------------|-----------------------------------------------------------------------------------------------------------------------------------------------------------------------------------------------------------------------------------------------------------------------------------------------------------------------------------------------------------------------------------------------------------------------------------------------------------------------------------------------------------------------------------------------------------------------------------------------------------------------------------------|
| 1 | ocA | | <p>Over-current during acceleration (Output current exceeds triple rated current during acceleration.)</p> <p>corrective action</p> <ol style="list-style-type: none"> 1. Short-circuit at motor output: Check for possible poor insulation at the output. 2. Acceleration Time is too short: Increase the Acceleration Time. 3. AC motor drive output power is too small: Replace the AC motor drive with a higher power model. |
| 2 | ocD | | <p>Over-current during deceleration (Output current exceeds triple rated current during deceleration.)</p> <p>corrective action</p> <ol style="list-style-type: none"> 1. Short-circuit at motor output: Check for possible poor insulation at the output. 2. Deceleration Time is too short: Increase the Deceleration Time. 3. AC motor drive output power is too small: Replace the AC motor drive with a higher power model. |
| 3 | ocN | | <p>Over-current during steady state operation (Output current exceeds triple rated current during constant speed.)</p> <p>corrective action</p> <ol style="list-style-type: none"> 1. Short-circuit at motor output: Check for possible poor insulation at the output. 2. Sudden increase in motor loading: Check for possible motor stall. 3. AC motor drive output power is too small: Replace the AC motor drive with a higher power model. |
| 4 | GFF | | <p>Ground fault</p> <p>corrective action</p> <p>When (one of) the output terminal(s) is grounded, short circuit current is more than 50% of AC motor drive rated current, the AC motor drive power module may be damaged.</p> <p>NOTE: The short circuit protection is to protect the AC motor drive, not to protect the user.</p> <ol style="list-style-type: none"> 1. Check the wiring connections between the AC motor drive and motor for possible short circuits, also to ground. 2. Check whether the IGBT power module is damaged. 3. Check for possible poor insulation at the output. |
| 5 | ocC | | <p>Short-circuit is detected between upper bridge and lower bridge of the IGBT module.</p> <p>corrective action</p> <p>Return to the factory.</p> |

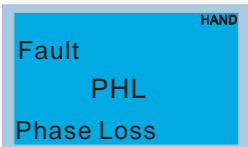
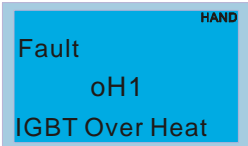
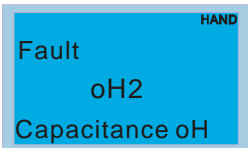
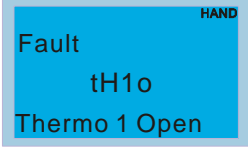
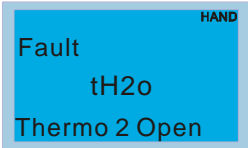

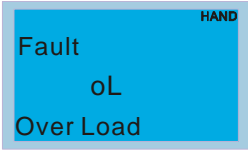
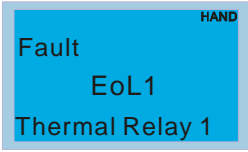
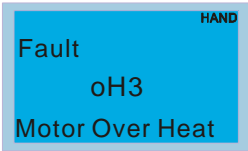
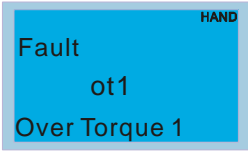
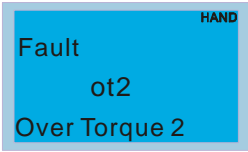
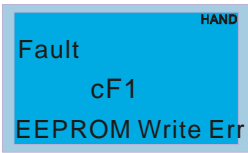
| | | | |
|----|-----|-------------------------------------------------------------------------------------|---------------------------------------------------------------------------------------------------------------------------------------------------------------------------------------------------------------------------------------------------------------------------------------------------------------------------------------------------------------------------------------------------------------------------------------------|
| 6 | ocS |  | <p>Hardware failure in over current detection</p> <p>corrective action</p> <p>Return to the factory.</p> |
| 7 | ovA |  | <p>DC BUS over-voltage during acceleration</p> <p>230V: DC 405V; 460V: DC 810V</p> <p>corrective action</p> <ol style="list-style-type: none"> 1. Check if the input voltage falls within the rated AC motor drive input voltage range. 2. Check for possible voltage transients. 3. If DC BUS over-voltage due to regenerative voltage, increase the acceleration time or add an optional brake resistor. |
| 8 | ovd |  | <p>DC BUS over-voltage during deceleration</p> <p>230V: DC 405V; 460V: DC 810V</p> <p>corrective action</p> <ol style="list-style-type: none"> 1. Check if the input voltage falls within the rated AC motor drive input voltage range. 2. Check for possible voltage transients. 3. If DC BUS over-voltage due to regenerative voltage, increase the Deceleration Time or add an optional brake resistor. |
| 9 | ovn |  | <p>DC BUS over-voltage at constant speed</p> <p>230V: DC 405V; 460V: DC 810V</p> <p>corrective action</p> <ol style="list-style-type: none"> 1. Check if the input voltage falls within the rated AC motor drive input voltage range. 2. Check for possible voltage transients. 3. If DC BUS over-voltage due to regenerative voltage, increase the Deceleration Time or add an optional brake resistor. |
| 10 | ovS |  | <p>Hardware failure in voltage detection</p> <p>corrective action</p> <ol style="list-style-type: none"> 1. Check if the input voltage falls within the rated AC motor drive input voltage range. 2. Check for possible voltage transients. |
| 11 | LvA |  | <p>DC BUS voltage is less than the setting at Pr.06-00 during acceleration.</p> <p>corrective action</p> <ol style="list-style-type: none"> 1. Check if the input voltage is normal. 2. Check for possible sudden load. |
| 12 | Lvd |  | <p>DC BUS voltage is less than Pr.06-00 during deceleration.</p> <p>corrective action</p> <ol style="list-style-type: none"> 1. Check if the input voltage is normal. 2. Check for possible sudden load. |

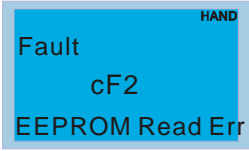
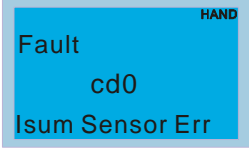
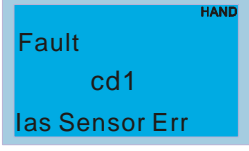
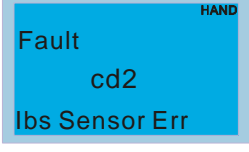
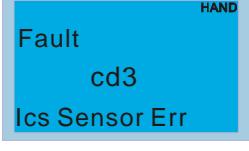
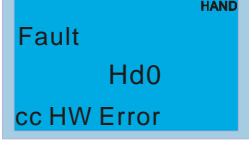
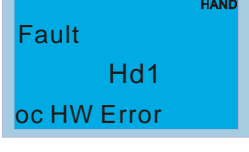
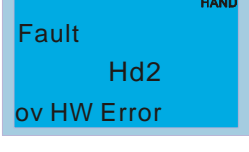
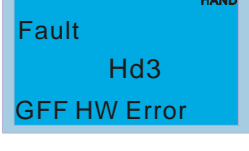
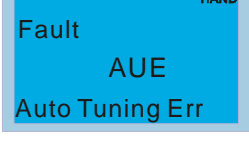
| | | | |
|----|------|-------------------------------------------------------------------------------------|------------------------------------------------------------------------------------------------------------------------------------------------------------------------------------------------------------------------------------------------------------------------------------------------------------------------------------------------------------------------------------------------------------------------------------------------------------------------------------------------------------------------------------------------------------------------------------------|
| 13 | LvN |  | <p>DC BUS voltage is less than the setting at Pr.06-00 at constant speed</p> <p>corrective action</p> <ol style="list-style-type: none"> 1. Check if the input voltage is normal. 2. Check for possible sudden load. |
| 14 | LvS |  | <p>DC BUS voltage is less than the setting at Pr.06-00 at stop.</p> <p>corrective action</p> <ol style="list-style-type: none"> 1. Check if the input voltage is normal. 2. Check for possible sudden load. |
| 15 | PHL |  | <p>Phase Loss</p> <p>corrective action</p> <p>Check Power Source Input if all 3 input phases are connected without loose contacts.</p> |
| 16 | oH1 |  | <p>IGBT overheating IGBT temperature exceeds protection level 3~5HP, 50~60HP: 105°C 7.5~30HP: 95 °C 40~100HP: 110 °C</p> <p>corrective action</p> <ol style="list-style-type: none"> 1. Ensure that the ambient temperature falls within the specified temperature range. 2. Make sure that the ventilation holes are not obstructed. 3. Remove any foreign objects from the heatsinks and check for possible dirty heatsink fins. 4. Check the fan and clean it. 5. Provide enough spacing for adequate ventilation. |
| 17 | oH2 |  | <p>Capacitor overheating. Capacitor's temperature exceeds the protection level. 3~100HP: 65°C.</p> <p>corrective action</p> <ol style="list-style-type: none"> 1. Ensure that the ambient temperature falls within the specified temperature range. 2. Make sure heat sink is not obstructed. Check if the fan is operating 3. Check if there is enough ventilation clearance for AC motor drive. |
| 18 | tH1o |  | <p>IGBT overheating protection fault</p> <p>corrective action</p> <p>Return to the factory.</p> |
| 19 | tH2o |  | <p>Capacitor module overheating fault</p> <p>corrective action</p> <p>Return to the factory.</p> |

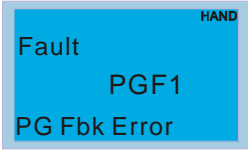
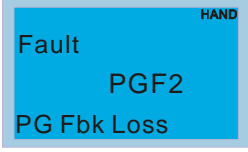
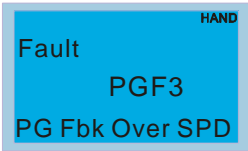
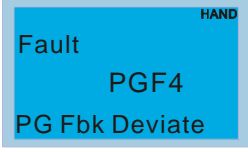
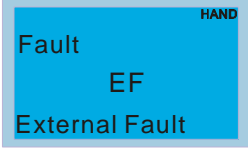
| | | | |
|----|------|-------------------------------------------------------------------------------------|------------------------------------------------------------------------------------------------------------------------------------------------------------------------------------------------------------------------------------------------------------------------------------------------------------------------------------------------------------------------------------------------------------------------------------------------------------------------------------------------------------------------------------------------------------------------------------------------------------------------------------------------------------------------------------------------------------------------------------------------------|
| 20 | FAn |  | <p>Cooling fan doesn't turn properly</p> <p>corrective action</p> <p>Verify if the cooling fan is covered by dust and needs to be cleaned. Return to the factory if necessary.</p> |
| 21 | oL |  | <p>The AC motor drive detects excessive drive output current. The output current causes the motor drive to be overload. If the output current is 150% higher than the rated current, the motor drive can last for 60 seconds.</p> <p>corrective action</p> <ol style="list-style-type: none"> 1. Check if the motor is overload. 2. Increase the output capacity of the motor drive. |
| 22 | EoL1 |  | <p>The output current causes the motor to be overload. If the output current is 150% higher than the rated current, the motor can last for 60 seconds.</p> <p>corrective action</p> <ol style="list-style-type: none"> 1. Check the setting of full-load current of motor (Pr.05-01). 2. Check if motor 1 is overload, change to a higher power motor. |
| 24 | oH3 |  | <p>Motor overheating</p> <p>The AC motor drive detecting internal temperature exceeds the setting of Pr.06-27 (PTC level).</p> <p>corrective action</p> <ol style="list-style-type: none"> 1. Make sure that the motor is not obstructed. 2. Ensure that the ambient temperature falls within the specified temperature range. 3. Change to a higher power motor. |
| 26 | ot1 |  | |
| 27 | ot2 |  | <p>The ot1 and ot2 fault codes will pop up when:</p> <ul style="list-style-type: none"> - the output current exceeds the setting at Pr06-06 <Over-torque Detection Level (OT1)> and Pr06-09 <Over-torque Protection Level (OT2)>, - the output current lasts longer than the time setting at Pr06-07 and Pr06-10. - Pr06-05 or Pr06-08 is set to 2 or 4. <p>corrective action</p> <ol style="list-style-type: none"> 1. Check if the motor is overload. 2. Check if the setting of Pr05-01 IM <Full-load current of the motor>and Pr08-01 PM <Full-load current of the motor> are appropriate. 3. If necessary, increase the output capacity of the motor. |
| 30 | cF1 |  | <p>Internal EEPROM cannot be programmed.</p> <p>corrective action</p> <ol style="list-style-type: none"> 1. Press "RESET" key to the factory setting. 2. Return to the factory. |

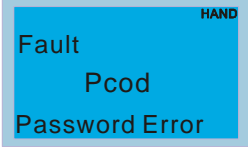
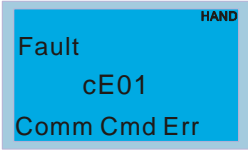
| | | | |
|----|------------|------------------------------------------------------------------------------------------------------------------------------|-------------------------------------------------------------------------------------------------------------------------------------------------------------------------------------------------------------------------------------------------|
| 31 | <i>cF2</i> |  <p>Fault cF2 EEPROM Read Err</p> | <p>Internal EEPROM cannot be read.</p> <p>corrective action</p> <ol style="list-style-type: none"> 1. Press "RESET" key to the factory setting. 2. Return to the factory. |
| 32 | <i>cd0</i> |  <p>Fault cd0 Isum Sensor Err</p> | <p>Hardware failure in current detection</p> <p>corrective action</p> <p>Reboot the power. If fault code is still displayed on the keypad, return to the factory.</p> |
| 33 | <i>cd1</i> |  <p>Fault cd1 Ias Sensor Err</p> | <p>U-phase current detection error</p> <p>corrective action</p> <p>Reboot the power. If fault code is still displayed on the keypad, return to the factory.</p> |
| 34 | <i>cd2</i> |  <p>Fault cd2 Ibs Sensor Err</p> | <p>V-phase current detection error</p> <p>corrective action</p> <p>Reboot the power. If fault code is still displayed on the keypad, return to the factory.</p> |
| 35 | <i>cd3</i> |  <p>Fault cd3 Ics Sensor Err</p> | <p>W-phase current detection error</p> <p>corrective action</p> <p>Reboot the power. If fault code is still displayed on the keypad, return to the factory.</p> |
| 36 | <i>Hd0</i> |  <p>Fault Hd0 cc HW Error</p> | <p>CC (current clamp)</p> <p>corrective action</p> <p>Reboot the power. If fault code is still displayed on the keypad, return to the factory.</p> |
| 37 | <i>Hd1</i> |  <p>Fault Hd1 oc HW Error</p> | <p>OC hardware error</p> <p>corrective action</p> <p>Reboot the power. If fault code is still displayed on the keypad, return to the factory.</p> |
| 38 | <i>Hd2</i> |  <p>Fault Hd2 ov HW Error</p> | <p>OV hardware error</p> <p>corrective action</p> <p>Reboot the power. If fault code is still displayed on the keypad, return to the factory.</p> |
| 39 | <i>Hd3</i> |  <p>Fault Hd3 GFF HW Error</p> | <p>GFF hardware error</p> <p>corrective action</p> <p>Reboot the power. If fault code is still displayed on the keypad, return to the factory.</p> |
| 40 | <i>AUE</i> |  <p>Fault AUE Auto Tuning Err</p> | <p>Auto-tuning error</p> <p>corrective action</p> <ol style="list-style-type: none"> 1. Check cabling between drive and motor 2. Check if the motor capacity and the parameter setting are appropriate. Then try again. |

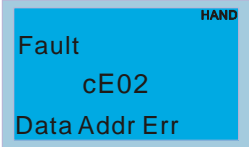
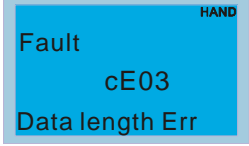
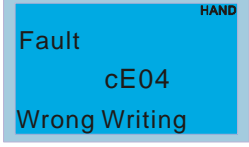
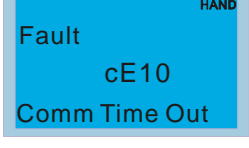
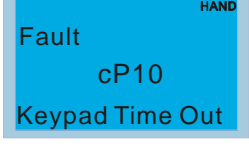
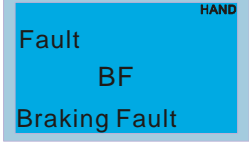
| | | | |
|----|------|-------------------------------------------------------------------------------------|----------------------------------------------------------------------------------------------------------------------------------------------------------------------------------------------------------------------------------------------------------------------------------------------------------------------------------------------------------------------------|
| 42 | PGF1 |  | PG feedback error corrective action .When PG feedback control is enabled; check if Pr10-01<Encoder Pulse> is set to 0. |
| 43 | PGF2 |  | PG feedback loss corrective action Check the wiring of the PG feedback. |
| 44 | PGF3 |  | PG feedback over speed corrective action 1. Check the wiring of the PG feedback. 2. Check if the settings of PI gain and deceleration are correct (Pr10-05, Pr10-06). 3. Return to the factory. |
| 45 | PGF4 |  | PG slip error corrective action 1. Check the wiring of the PG feedback. 2. Check if the settings of PI gain and deceleration are appropriate (Pr10-07, Pr10-08). 3. Return to the factory. |
| 49 | EF |  | When Multi-Function Input Command (MI1 to MI8) is set to #10 EF input (Pr07-28) and when multi-function input terminals are triggered to close, the motor drive stop running. corrective action 1. Input EF (N.O.) on external terminal is closed to GND. Output U, V, W will be turned off. 2. Press the RESET button on the keypad to clear the fault signal. . |
| 50 | EF1 |  | Emergency Stop corrective action 1. When the multi-function input terminals MI1 to MI6 are set to emergency stop, the AC motor drive stops outputting U, V, W and the motor coasts to stop. 2. Press RESET after fault has been cleared. |
| 52 | Pcod |  | Password error. After inputting three consecutive times the wrong password, the keypad will be locked. corrective action Power down and power back up again the motor drive to clear the lock and re-enter the correct password See Pr.00-07 and 00-08 for more information. |
| 54 | cE01 |  | Illegal function code corrective action Check if the function code is correct (function code must be 03, 06, 10, 63). |

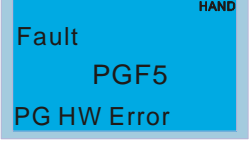
| | | | |
|----|-------|-------------------------------------------------------------------------------------------------------------------------------|-------------------------------------------------------------------------------------------------------------------------------------------------------------------------------------------------------------------------------------------------------------------------------------------------------------------------|
| 55 | cE02 |  <p>Fault cE02 Data Addr Err</p> | <p>Illegal data address (00H to 254H)</p> <p>The data address of 0X2XX is between 0X2000~0X2005. Any address not within this range is a fault</p> <p>corrective action</p> <p>Check if the communication address is correct.</p> |
| 56 | cE03 |  <p>Fault cE03 Data length Err</p> | <p>Illegal data length</p> <p>The data length must be between 1 to 20 digits. Any length out of this range is a fault.</p> <p>corrective action</p> <p>Check if the data length is smaller than the minimum value or over the maximum value.</p> |
| 57 | cE04 |  <p>Fault cE04 Wrong Writing</p> | <p>Write value to read only communication address</p> <p>Communication addresses such as 0X21XX, 0X22XX are read only. If any command is sent to these addresses, there will be a fault.</p> <p>corrective action</p> <p>Check if the communication address is correct.</p> |
| 58 | cE 10 |  <p>Fault cE10 Comm Time Out</p> | <p>Modbus communication time-out(Pr09-02~09-03)</p> <p>corrective action</p> <p>Check if the wiring for the communication is correct.</p> |
| 59 | cP 10 |  <p>Fault cP10 Keypad Time Out</p> | <p>Keypad transmission time-out</p> <p>corrective action</p> <ol style="list-style-type: none"> 1. Check if the wiring for the communication is correct 2. Check if there is any wrong with the keypad |
| 60 | bF |  <p>Fault BF Braking Fault</p> | <p>Brake resistor fault</p> <p>corrective action</p> <p>If the fault code is still displayed on the keypad after pressing "RESET" key, return to the factory.</p> |
| 64 | MBF |  <p>Fault MBF Mech. Brake Fail</p> | <p>Mechanical brake fail, the feedback signal and the released signal are not consistent.</p> <p>corrective action</p> <ol style="list-style-type: none"> 1. Check if the mechanical brake signal is correct. 2. Check if the detection time setting of mechanical brake (Pr.02-35) is correct. |
| 65 | PGF5 |  <p>Fault PGF5 PG HW Error</p> | <p>PG card hardware error</p> <p>corrective action</p> <ol style="list-style-type: none"> 1. Check if the wiring of PG feedback is correct. 2. If fault code is still displayed on the keypad with correct PG feedback, please return to the factory. |

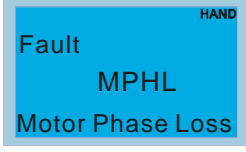
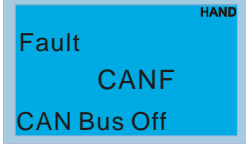
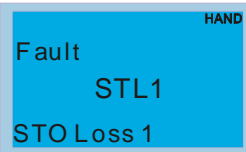
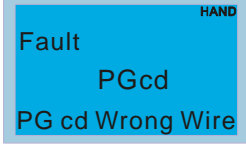
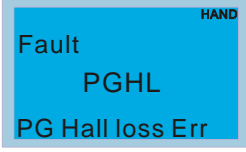
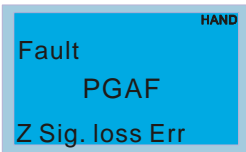
| | | | |
|----|----------|-------------------------------------------------------------------------------------|----------------------------------------------------------------------------------------------------------------------------------------------------------------------------------------------------------------------------------------------------------------------------------------------------------------------------------|
| 66 | MCF |  | <p>Electromagnetic contactor error, the feedback signal and the released signal are not consistent.</p> <p>corrective action</p> <ol style="list-style-type: none"> 1. Check if the signal of electromagnetic valve is correct. 2. Check if the setting of Pr.02-36 is correct. |
| 67 | MPHL |  | <p>Motor phase loss.</p> <p>corrective action</p> <ol style="list-style-type: none"> 1. Check cabling between drive and motor 2. Check if any output from the motor drive. 3. Return to the factory. |
| 68 | CANF |  | <p>CAN Bus off</p> <p>corrective action</p> <ol style="list-style-type: none"> 1. Check CAN Bus is wired correctly 2. Check PDO communication no time out |
| 69 | Reserved | | |
| 70 | Reserved | | |
| 71 | Reserved | | |
| 72 | STL1 |  | <p>STO1~SCM1 internal hardware error detected.</p> |
| 73 | PGcd |  | <p>PG cd wrong wiring</p> <p>corrective action</p> <p>Incorrect wiring for pin C+, C-, D+, D-. Refer to chapter 7-2 for correct wiring.</p> |
| 74 | PGHL |  | <p>PG absolute signal error</p> <p>corrective action</p> <ol style="list-style-type: none"> 1. Check if the encoders absolute positions (C+ C- and D+/D- are properly wired. 2. If the cables are properly wired but the fault code still displays on the keypad, return the motor drive to the factory. |
| 75 | PGAF |  | <p>PG Z phase signal loss</p> <p>corrective action</p> <ol style="list-style-type: none"> 1. Check if the encoder's Z phase signal and PG card are properly wired. 2. If the cables are properly wired but the fault code still displays on the keypad, return the motor drive to the factory. |

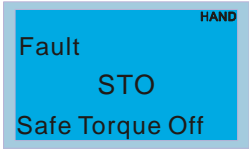
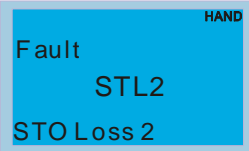
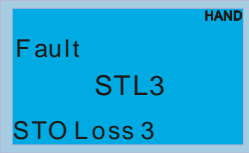
| | | | |
|----|------|-----------------------------------------------------------------------------------|-------------------------------------------------------------------------------|
| 76 | StO |  | Safety Torque Off function is enabled while parameter 06-49 is set to 0 or 2. |
| 77 | StL2 |  | STO2~SCM2 internal hardware error detected. |
| 78 | StL3 |  | STO1~SCM1 and STO2~SCM2 internal hardware error detected. |

15 Suggestions & Error Corrections for Standard AC Motor Drives

15-1 Maintenance and Inspections

15-2 Greasy Dirt Problem

15-3 Fiber Dust Problem

15-4 Erosion Problem

15-5 Industrial Dust Problem

15-6 Wiring and Installation Problem

15-7 Multi-function Input/Output Terminals Problem

The AC motor drive has a comprehensive fault diagnostic system that includes several different alarms and fault messages. Once a fault is detected, the corresponding protective functions will be activated. The following faults are displayed as shown on the AC motor drive digital keypad display. The six most recent faults can be read from the digital keypad or communication.

The AC motor drive is made up by numerous components, such as electronic components, including IC, resistor, capacitor, transistor, and cooling fan, relay, etc. These components can't be used permanently. They have limited-life even under normal operation. Preventive maintenance is required to operate this AC motor drive in its optimal condition, and to ensure a long life.

Check your AC motor drive regularly to ensure there are no abnormalities during operation and follows the precautions:



CAUTION

- ☑ Wait 5 seconds after a fault has been cleared before performing reset via keypad of input terminal.
 - ☑ When the power is off after 5 minutes for $\leq 22\text{kW}$ models and 10 minutes for $\geq 30\text{kW}$ models, please confirm that the capacitors have fully discharged by measuring the voltage between + and -. The voltage between + and - should be less than 25VDC.
 - ☑ Only qualified personnel can install, wire and maintain drives. Please take off any metal objects, such as watches and rings, before operation. And only insulated tools are allowed.
 - ☑ Never reassemble internal components or wiring.
 - ☑ Make sure that installation environment comply with regulations without abnormal noise, vibration and smell.
-

15-1 Maintenance and Inspections

Before the check-up, always turn off the AC input power and remove the cover. Wait at least 10 minutes after all display lamps have gone out, and then confirm that the capacitors have fully discharged by measuring the voltage between DC+ and DC-. The voltage between DC+ and DC- should be less than 25VDC.

Ambient environment

| Check Items | Methods and Criterion | Maintenance Period | | |
|-----------------------------------------------------------------------------------------------------------|------------------------------------------------------------------------------|-----------------------|-----------|----------|
| | | Daily | Half Year | One Year |
| Check the ambient temperature, humidity, vibration and see if there are any dust, gas, oil or water drops | Visual inspection and measurement with equipment with standard specification | <input type="radio"/> | | |
| If there are any dangerous objects | Visual inspection | <input type="radio"/> | | |

Voltage

| Check Items | Methods and Criterion | Maintenance Period | | |
|---------------------------------------------------------------------|-----------------------------------------------------|-----------------------|-----------|----------|
| | | Daily | Half Year | One Year |
| Check if the voltage of main circuit and control circuit is correct | Measure with multimeter with standard specification | <input type="radio"/> | | |

Digital Keypad Display

| Check Items | Methods and Criterion | Maintenance Period | | |
|----------------------------------|-----------------------|-----------------------|-----------|----------|
| | | Daily | Half Year | One Year |
| Is the display clear for reading | Visual inspection | <input type="radio"/> | | |
| Any missing characters | Visual inspection | <input type="radio"/> | | |

Mechanical parts

| Check Items | Methods and Criterion | Maintenance Period | | |
|---------------------------------------------|-----------------------------|--------------------|-----------------------|----------|
| | | Daily | Half Year | One Year |
| If there is any abnormal sound or vibration | Visual and aural inspection | | <input type="radio"/> | |
| If there are any loose screws | Tighten the screws | | <input type="radio"/> | |
| If any part is deformed or damaged | Visual inspection | | <input type="radio"/> | |
| If there is any color change by overheating | Visual inspection | | <input type="radio"/> | |
| If there is any dust or dirt | Visual inspection | | <input type="radio"/> | |

Main circuit

| Check Items | Methods and Criterion | Maintenance Period | | |
|---------------------------------------------------------------------------------------------------------|----------------------------------------------------------------------------------|-----------------------|-----------------------|----------|
| | | Daily | Half Year | One Year |
| If there are any loose or missing screws | Tighten or replace the screw | <input type="radio"/> | | |
| If machine or insulator is deformed, cracked, damaged or with color change due to overheating or ageing | Visual inspection NOTE: Please ignore the color change of copper plate | | <input type="radio"/> | |
| If there is any dust or dirt | Visual inspection | | <input type="radio"/> | |

Terminals and wiring of main circuit

| Check Items | Methods and Criterion | Maintenance Period | | |
|-----------------------------------------------------------------------------|-----------------------|-----------------------|-----------------------|----------|
| | | Daily | Half Year | One Year |
| If the terminal or the plate is color change or deformation due to overheat | Visual inspection | | <input type="radio"/> | |
| If the insulator of wiring is damaged or color change | Visual inspection | | <input type="radio"/> | |
| If there is any damage | Visual inspection | <input type="radio"/> | | |

DC capacity of main circuit

| Check Items | Methods and Criterion | Maintenance Period | | |
|--------------------------------------------------------------------|-----------------------|-----------------------|-----------|----------|
| | | Daily | Half Year | One Year |
| If there is any leak of liquid, color change, crack or deformation | Visual inspection | <input type="radio"/> | | |
| If the safety valve is not removed? If valve is inflated? | Visual inspection | <input type="radio"/> | | |
| Measure static capacity when required | | <input type="radio"/> | | |

Resistor of main circuit

| Check Items | Methods and Criterion | Maintenance Period | | |
|--------------------------------------------------------------------|-----------------------------------------------------|-----------------------|-----------|----------|
| | | Daily | Half Year | One Year |
| If there is any peculiar smell or insulator cracks due to overheat | Visual inspection, smell | <input type="radio"/> | | |
| If there is any disconnection | Visual inspection | <input type="radio"/> | | |
| If connection is damaged? | Measure with multimeter with standard specification | <input type="radio"/> | | |

Transformer and reactor of main circuit

| Check Items | Methods and Criterion | Maintenance Period | | |
|------------------------------------------------------|------------------------------------|-----------------------|-----------|----------|
| | | Daily | Half Year | One Year |
| If there is any abnormal vibration or peculiar smell | Visual, aural inspection and smell | <input type="radio"/> | | |

Magnetic contactor and relay of main circuit

| Check Items | Methods and Criterion | Maintenance Period | | |
|--------------------------------|-----------------------------|-----------------------|-----------|----------|
| | | Daily | Half Year | One Year |
| If there are any loose screws | Visual and aural inspection | <input type="radio"/> | | |
| If the contact works correctly | Visual inspection | <input type="radio"/> | | |

Printed circuit board and connector of main circuit

| Check Items | Methods and Criterion | Maintenance Period | | |
|-------------------------------------------------------------|--------------------------------------------------------------|--------------------|-----------------------|----------|
| | | Daily | Half Year | One Year |
| If there are any loose screws and connectors | Tighten the screws and press the connectors firmly in place. | | <input type="radio"/> | |
| If there is any peculiar smell and color change | Visual and smell inspection | | <input type="radio"/> | |
| If there is any crack, damage, deformation or corrosion | Visual inspection | | <input type="radio"/> | |
| If there is any liquid is leaked or deformation in capacity | Visual inspection | | <input type="radio"/> | |

Cooling fan of cooling system

| Check Items | Methods and Criterion | Maintenance Period | | |
|----------------------------------------------|-------------------------------------------------------------------------------------------------------------------------|--------------------|-----------------------|----------|
| | | Daily | Half Year | One Year |
| If there is any abnormal sound or vibration | Visual, aural inspection and turn the fan with hand (turn off the power before operation) to see if it rotates smoothly | | <input type="radio"/> | |
| If there is any loose screw | Tighten the screw | | <input type="radio"/> | |
| If there is any color change due to overheat | Change fan | | <input type="radio"/> | |

Ventilation channel of cooling system

| Check Items | Methods and Criterion | Maintenance Period | | |
|------------------------------------------------------------------------|-----------------------|--------------------|-----------|----------|
| | | Daily | Half Year | One Year |
| If there is any obstruction in the heat sink, air intake or air outlet | Visual inspection | | ○ | |

 **NOTE**

Please use the neutral cloth for clean and use dust cleaner to remove dust when necessary.

15-2 Greasy Dirt Problem

Serious greasy dirt problems generally occur in processing industries such as machine tools, punching machines and so on. Please be aware of the possible damages that greasy oil may cause to your drive:

1. Electronic components that silt up with greasy oil may cause the drive to burn out or even explode.
2. Most greasy dirt contains corrosive substances that may damage the drive.

Solution:

Install the AC motor drive in a standard cabinet to keep it away from dirt. Clean and remove greasy dirt regularly to prevent damage of the drive.

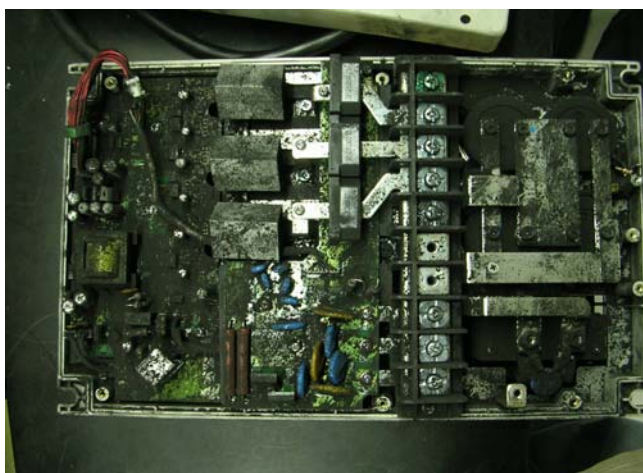

15-3 Fiber Dust Problem

Serious fiber dust problems generally occur in the textile industry. Please be aware of the possible damages that fiber may cause to your drives:

1. Fiber that accumulates or adheres to the fans will lead to poor ventilation and cause overheating problems.
2. Plant environments in the textile industry have higher degrees of humidity that may cause the drive to burn out, become damaged or explode due to wet fiber dust adhering to the devices.

Solution:

Install the AC motor drive in a standard cabinet to keep it away from fiber dust. Clean and remove fiber dust regularly to prevent damage to the drive.

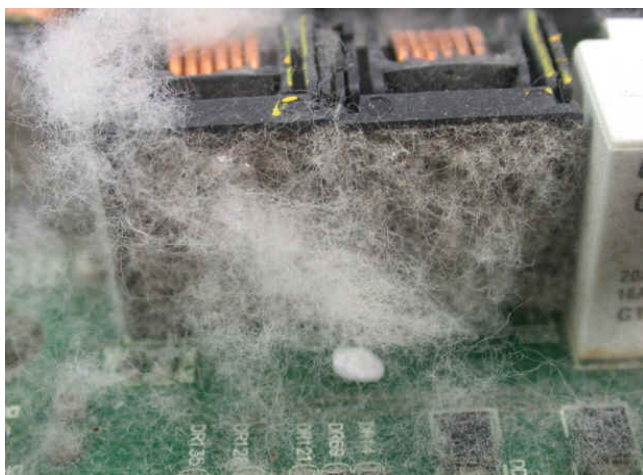

15-4 Erosion Problem

Erosion problems may occur if any fluids flow into the drives. Please be aware of the damages that erosion may cause to your drive.

1. Erosion of internal components may cause the drive to malfunction and possibility to explode.

Solution:

Install the AC motor drive in a standard cabinet to keep it away from fluids. Clean the drive regularly to prevent erosion.

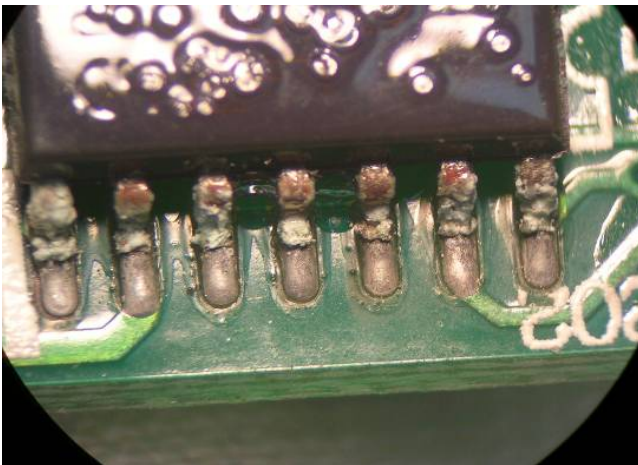
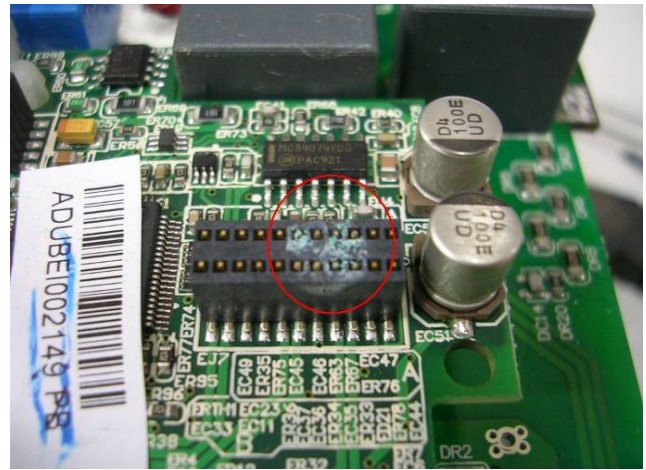
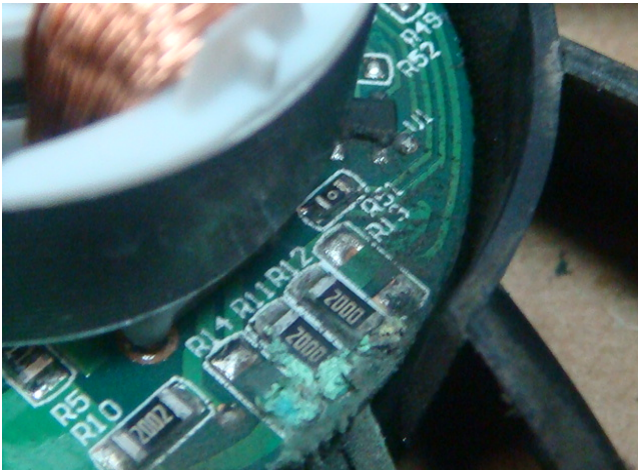

15-5 Industrial Dust Problem

Serious industrial dust pollution frequently occurs in stone processing plants, flour mills, cement plants, and so on. Please be aware of the possible damage that industrial dust may cause to your drives:

1. Dust accumulating on electronic components may cause overheating problem and shorten the service life of the drive.
2. Conductive dust may damage the circuit board and may even cause the drive to explode.

Solution:

Install the AC motor drive in a standard cabinet and cover the drive with a dust cover. Clean the cabinet and ventilation hole regularly for good ventilation.

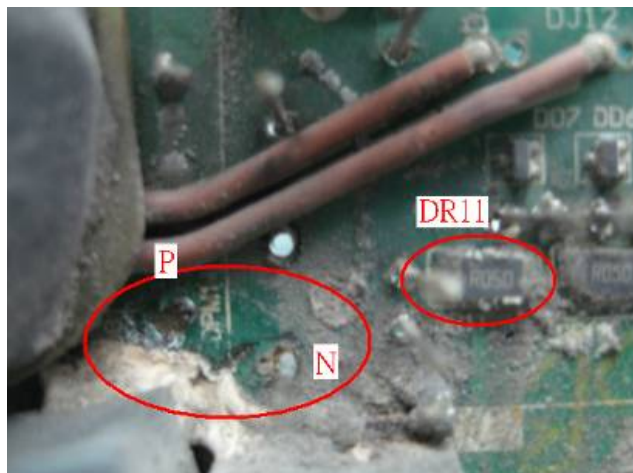
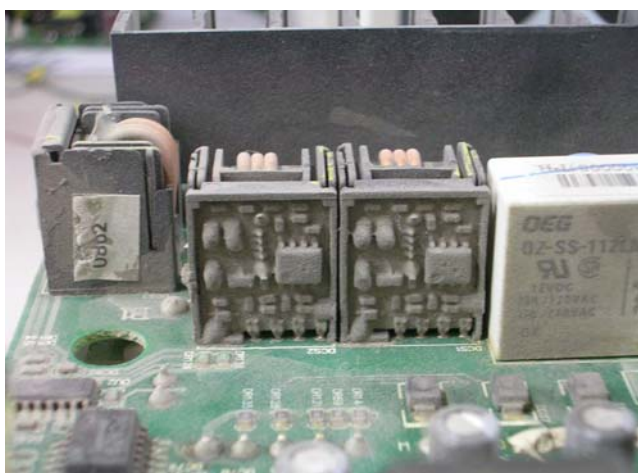

15-6 Wiring and Installation Problem

When wiring the drive, the most common problem is wrong wire installation or poor wiring. Please be aware of the possible damages that poor wiring may cause to your drives:

1. Screws are not fully fastened. Occurrence of sparks as impedance increases.
2. If a customer has opened the drive and modified the internal circuit board, the internal components may have been damaged.

Solution:

Ensure all screws are fastened when installing the AC motor drive. If the AC motor drive functions abnormally, send it back to the repair station. **DO NOT** try to reassemble the internal components or wire.

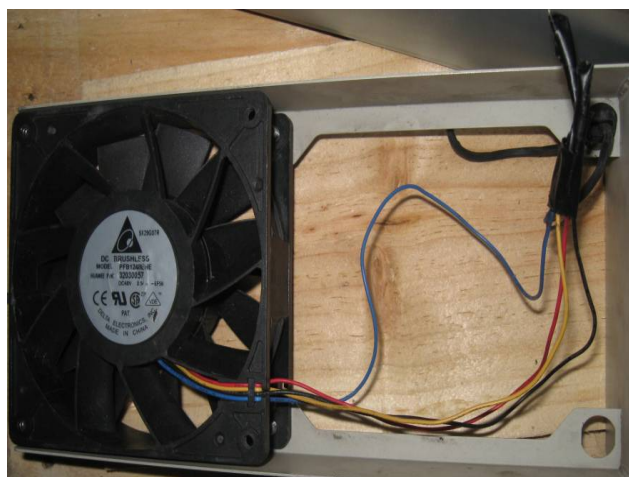
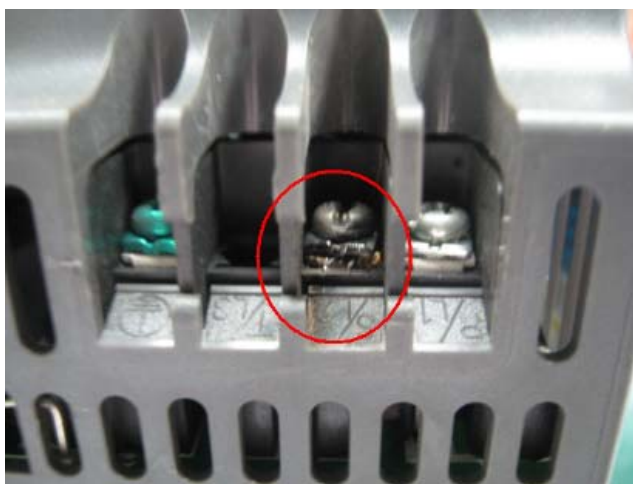

15-7 Multi-function Input/Output Terminals Problem

Multi-function input/output terminal errors are generally caused by over usage of terminals and not following specifications. Please be aware of the possible damages that errors on multi-function input/output terminals may cause to your drives:

1. Input/output circuit may burn out when the terminal usage exceeds its limit.

Solution:

Refer to the user manual for multi-function input output terminals usage and follow the specified voltage and current. DO NOT exceed the specification limits.

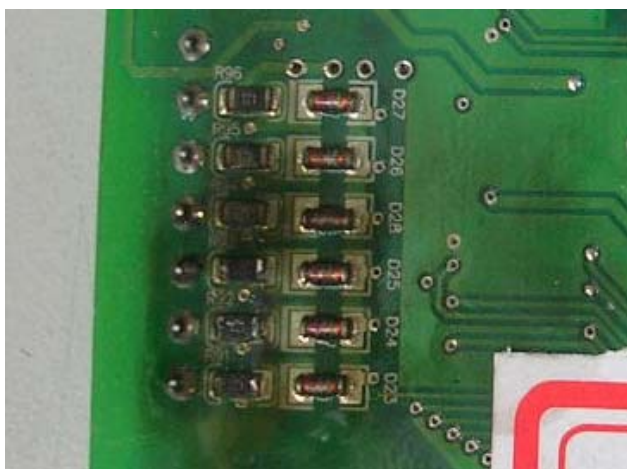
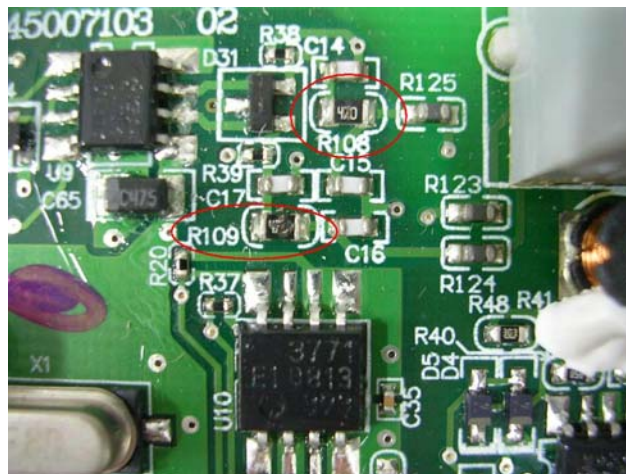
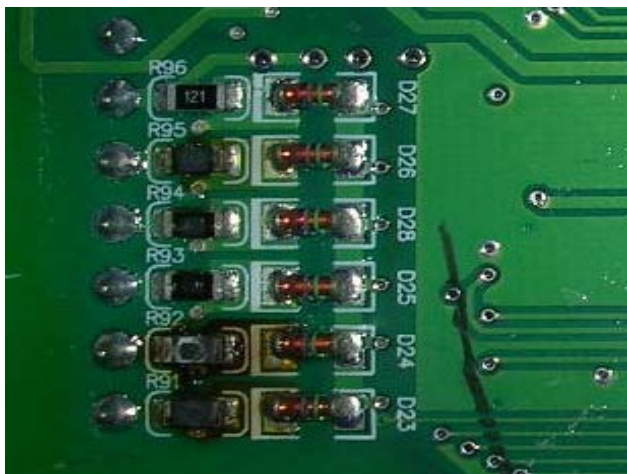

16 Functions of Safety Torque Off*

(*Safety Torque Off = STO)

16-1 Failure Rate of the drive's safety function

16-2 Description of STO's Functions

16-3 Wiring diagrams

16-4 Related Parameters

16-5 Description of Operating Sequence Diagrams

16-6 Error codes related to STO

16-1 Failure Rate of the drive's safety function

| Item | Definition | Standard | Performance |
|------------------------|----------------------------------------------|------------|----------------------------------------|
| SFF | Safe Failure Fraction | IEC61508 | Channel 1: 80.08% Channel 2: 68.91% |
| HFT (Type A subsystem) | Hardware Fault Tolerance | IEC61508 | 1 |
| SIL | Safety Integrity Level | IEC61508 | SIL 2 |
| | | IEC62061 | SILCL 2 |
| PFH | Average frequency of dangerous failure [h-1] | IEC61508 | 9.56×10^{-10} |
| PFD_{av} | Probability of Dangerous Failure on Demand | IEC61508 | 4.18×10^{-6} |
| Category | Category | ISO13849-1 | Category 3 |
| PL | Performance level | ISO13849-1 | d |
| $MTTF_d$ | Mean time to dangerous failure | ISO13849-1 | High |
| DC | Diagnostic coverage | ISO13849-1 | Low |

16-2 Description of STO's Functions

The purpose of the STO function is to cut off the power supply of the motor to prevent the production of torque force. The STO function is run by two independent hardware to control the drive signals emitted by the motor's current then to cut off motor drive's power module output in order to stop safely the motor drive.

The terminal functions is described in the table below,

Table 1: Description of Terminal Functions

| Signal | Channel | Status of Photocoupler | | | |
|----------------------|-----------|------------------------|-------------------------------------|-------------------------------------|------------------------------------|
| STO signal | STO1~SCM1 | ON(High) | ON(High) | OFF(Low) | OFF(Low) |
| | STO2~SCM2 | ON(High) | OFF(Low) | ON(Low) | OFF(Low) |
| Driver Output Status | | Ready | STL2 mode (Torque output off) | STL1 mode (Torque output off) | STO mode (Torque Output Off) |

- STO is Safe Torque Off
- STL1~STL3 means STO hardware abnormal
- STO1~SCM1 ON (High): means STO1~SCM1 has connect to a +24VDC power supply.
- STO2~SCM2 ON (High): means STO2~SCM2 has connect to a +24V power supply.
- STO1~SCM1 OFF (Low): means STO1~SCM1 hasn't connect to a +24VDC power supply.
- STO2~SCM2 OFF (Low): means STO2~SCM2 hasn't connect to a +24VDC power supply.

16-3 Wiring diagrams

16-3-1 Internal Safety Circuit diagram as shown below:

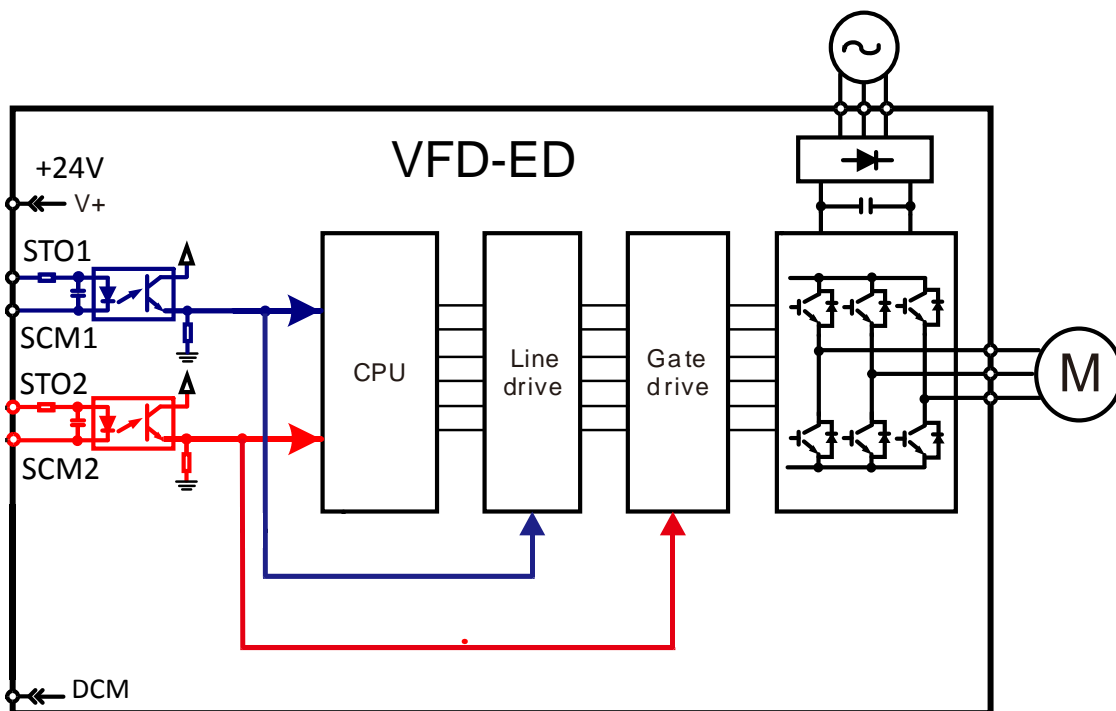

16-3-2 As shown in the diagram D below, the factory setting of terminals +24V-STO1-STO2 and terminals SCM1-SCM2-DCM is short-circuiting.

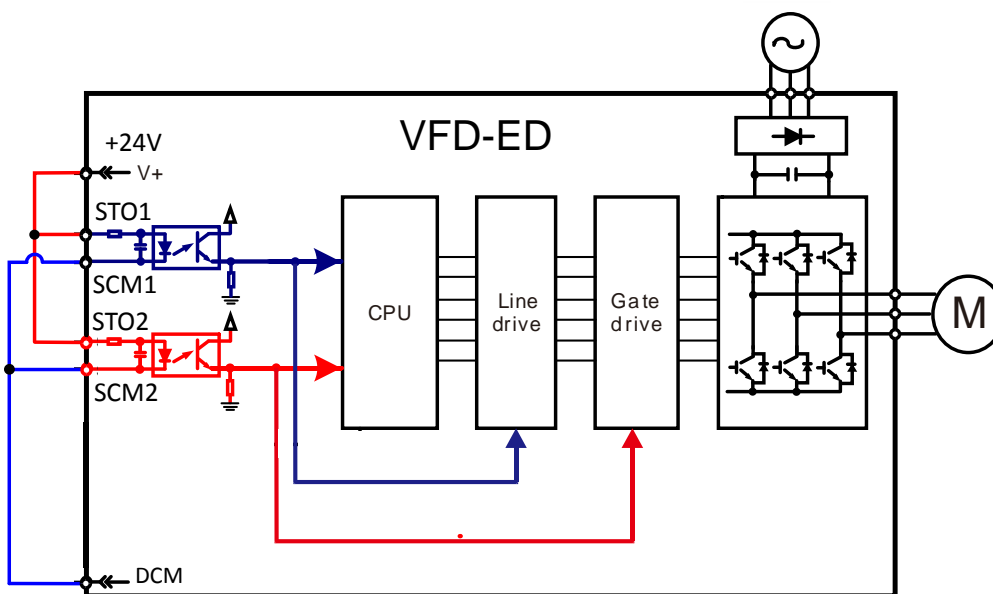
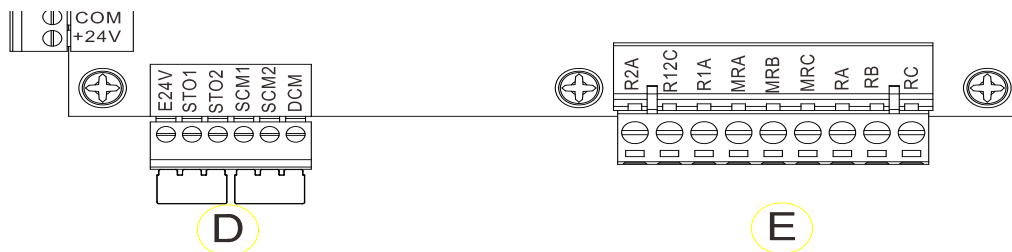

16-3-3 Control Circuit Wiring Diagram

- 1. Remove the short-circuit between E24V-STO1-STO2 and DCM-SCM1-SCM2.
- 2. The wiring diagram is as shown below. The ESTOP must be closed during the normal situation so that the motor drive will be able to run.
- 3. At the STO mode, switch on ESTOP, the motor drive will stop outputting and the keypad panel will display STO.

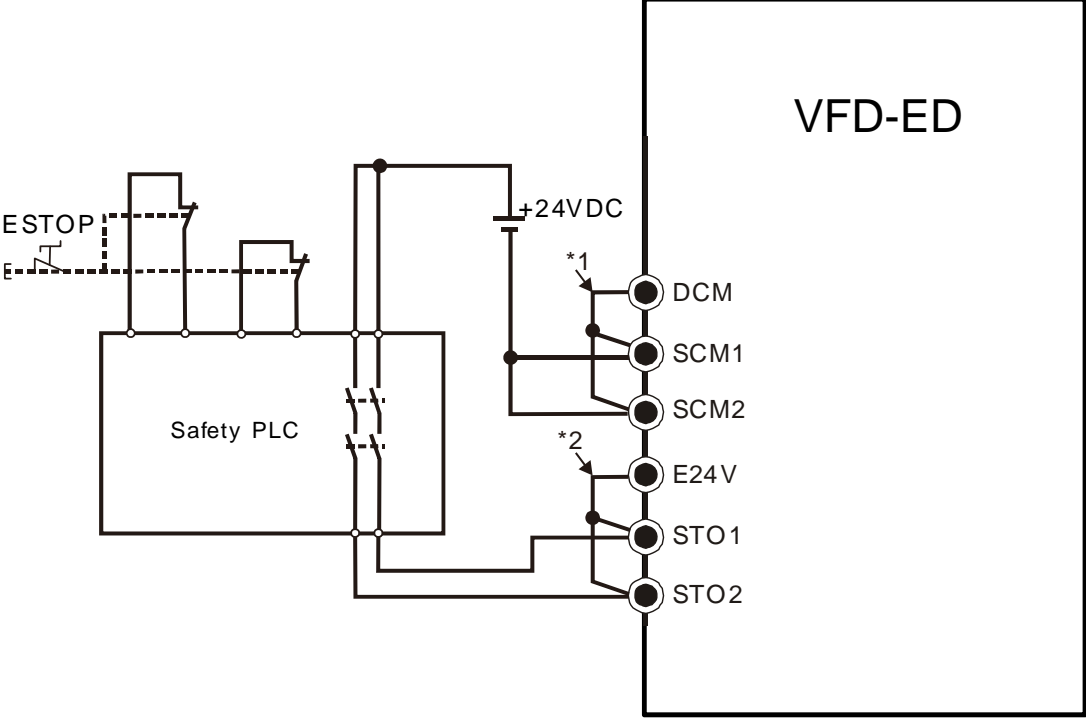

16-4 Related Parameters

| | | | | | | | |
|---|--------------|---------------------|--------------------------------------------------------------|--|--|--|--------------------|
| ↗ | 06-49 | STO Latch Selection | | | | | |
| | | | | | | | Factory Setting: 0 |
| | | Setting | 0: STO alarm Latch | | | | |
| | | | 1: STO alarm no Latch | | | | |
| | | | 2: STO Latch (Warn and record running commands when stop) | | | | |
| | | | 3: STO No Latch (Warn and record running commands when stop) | | | | |

📖 When Pr06-49=0, STO alarm is latched which means once the cause of the alarm is cleared, a Reset command is required to clear the STO alarm.

📖 When Pr06-49=1, STO alarm is NOT latched which means once the cause of the alarm is cleared, the STO alarm will stop automatically.

📖 When in STL1~STL3 mode, STO alarm is latched and Pr06-49 cannot be set.

| | | | | | | | |
|---|--------------|-------------------------------------------------------------------------------------------------------------------------|----------------------------|--|--|--|---------------------|
| ↗ | 02-11 | Multi-function Output 1 RA, RB, RC (Relay1) | | | | | |
| | | | | | | | Factory Setting: 11 |
| ↗ | 02-12 | Multi-function Output 2 MRA, MRC (Relay2) | | | | | |
| | | | | | | | Factory Setting : 1 |
| ↗ | 02-13 | Multi-function Output 3 R1A(Relay 3) | | | | | |
| ↗ | 02-14 | Multi-function Output 4 R2A(Relay 4) | | | | | |
| ↗ | 02-15 | Multi-function Output 5 MO1 | | | | | |
| ↗ | 02-16 | Multi-function Output 6 MO2 | | | | | |
| | | | | | | | Factory Setting : 0 |
| | | Settings | | | | | |
| | | | 0: No function | | | | |
| | | | 1: Operation indication | | | | |
| | | | 11: Malfunction indication | | | | |
| | | | 42: STO Output Error | | | | |
| ↗ | 02-23 | Multi-output direction | | | | | |
| | | | | | | | Factory Setting : 0 |
| | | This parameter is bit setting. If the bit is 1, the multi-function output terminal will be act with opposite direction. | | | | | |

| Bit 11 | Bit 10 | Bit 9 | Bit 8 | Bit 7 | Bit 6 | Bit 5 | Bit 4 | Bit 3 | Bit 2 | Bit 1 | Bit 0 |
|--------|--------|-------|-------|-------|-------|-------|-------|-------|-------|-------|-------|
| - | - | - | - | - | - | MO2 | MO1 | R2A | R1A | MRA | RA |

📖 STO Output Error factory setting: Pr02-15(MO1 =42 SO Logic Output A). Set up Pr02-23 <Multi-output direction> to choose Logic Output B.

| Status of the Motor Drive | Output status of Safety | |
|---------------------------|------------------------------|--------------------------------------------|
| | Logic Output A (02-15=42) | Logic Output B (02-15=42) (02-23=16) |
| Normal | Broken circuit (Open) | Short circuit (Close) |
| STO | Short circuit (Close) | Broken circuit (Open) |
| STL1~STL3 | Short circuit (Close) | Broken circuit (Open) |

16-5 Description of Operating Sequence Diagrams

16-5-1 Normal Operation Status

As shown in Figure 01: When the STO1~SCM1 and STO2~SCM2= ON (safety function is not required), the motor drive will execute "Operating" or "Output Stop" according to the RUN/STOP command.

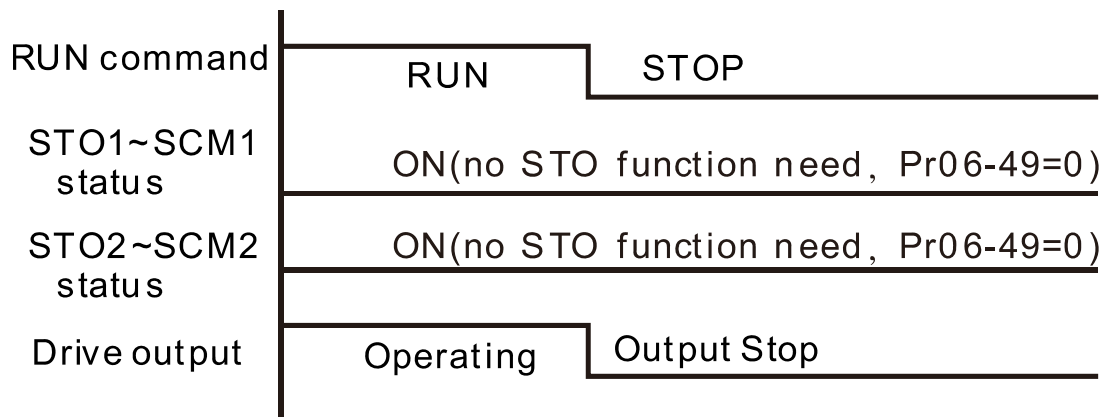

Figure 01

16-5-2 Pr06-49=0, STO alarm Latch

As shown in Figure 02, when both STO1~SCM1 and STO2~SCM2 channels are turned OFF (safety function is required) during operation, the STO function will be enabled and the motor drive will stop output regardless what kind of command is.

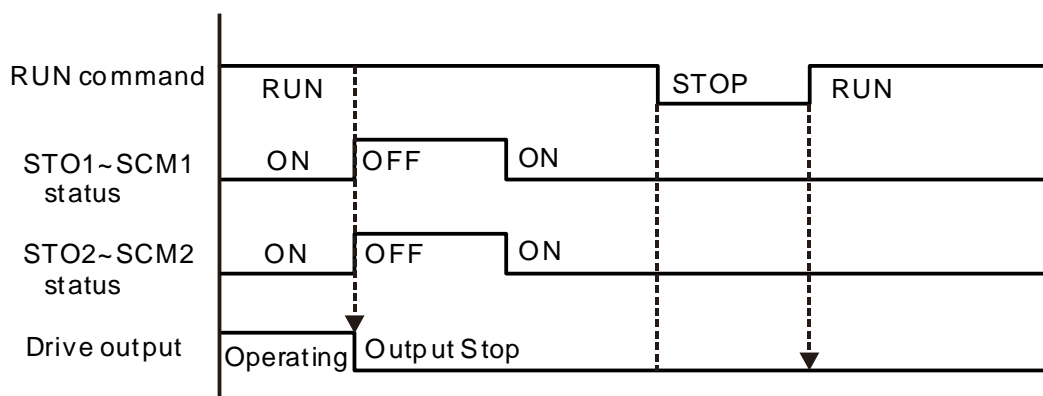

Figure 02

16-5-3 Pr06-49=1, STO alarm no Latch

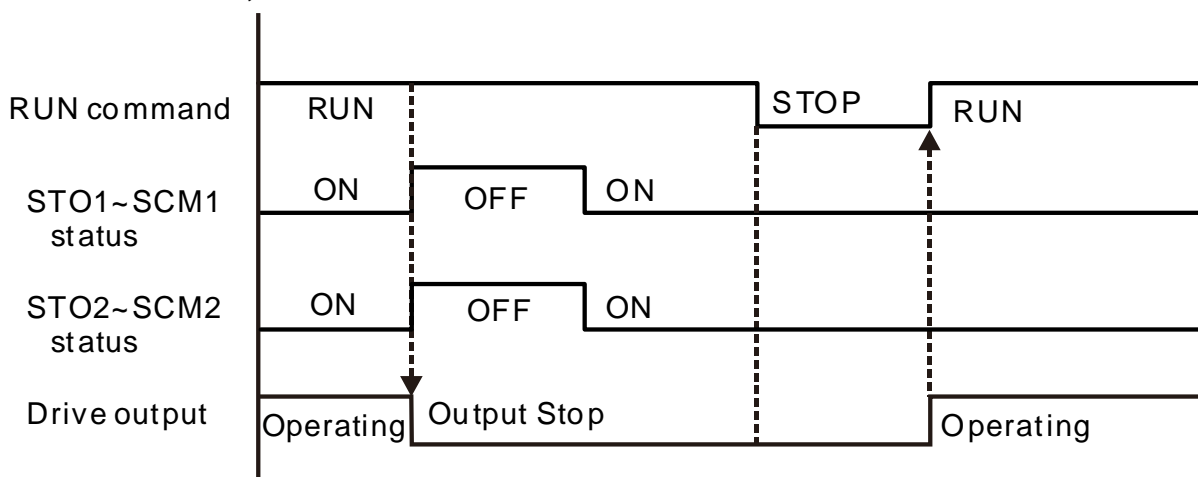

Figure 03

16-5-4 STL1

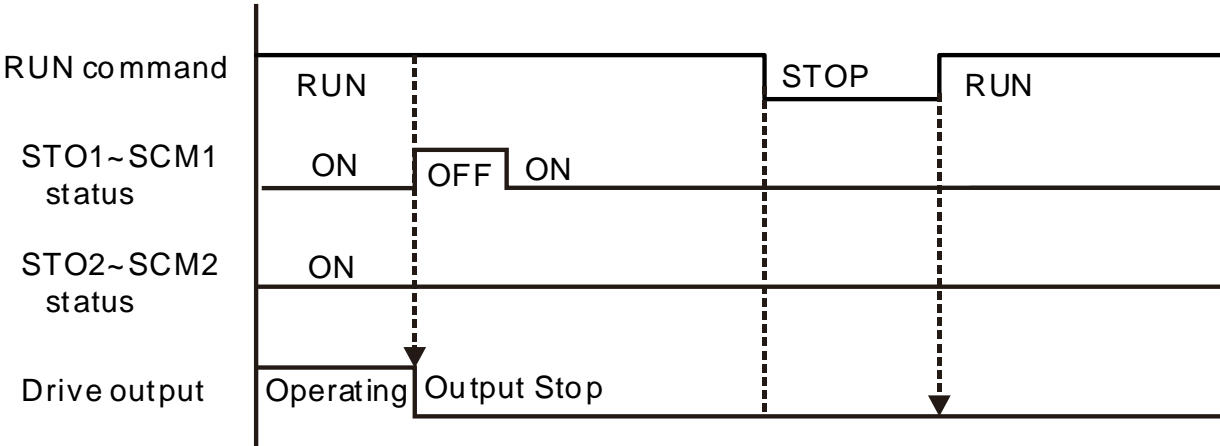

Figure 04

16-5-4 STL2

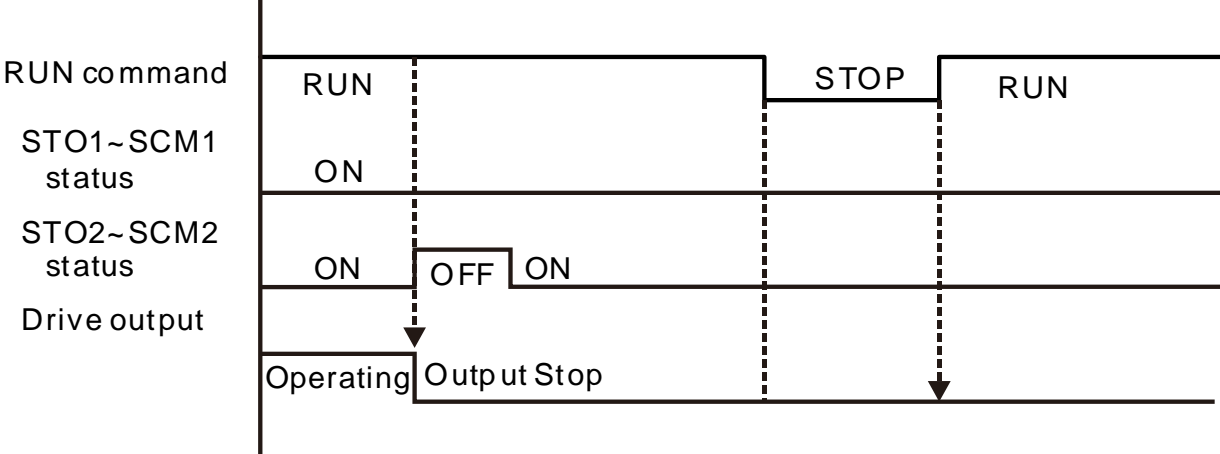

Figure 05

16-6 Fault codes related to STO

| | | | | | | | | | |
|-------|-------------------------------------|--|--|--|--|--|--|--|--|
| 06-16 | Present Fault Record | | | | | | | | |
| 06-17 | Second Most Recent Fault Record | | | | | | | | |
| 06-18 | Third Most Recent Fault Record | | | | | | | | |
| 06-19 | Fourth Recent Fault Record | | | | | | | | |
| 06-20 | Fifth Most Recent Fault Record | | | | | | | | |
| 06-21 | Sixth Most Recent Fault Record | | | | | | | | |
| | Setting | | | | | | | | |
| | 72: Safety torque loss (STL1) | | | | | | | | |
| | 76: Safety torque output stops(STO) | | | | | | | | |
| | 77: Safety torque loss 2 (STL2) | | | | | | | | |
| | 78: Safety torque loss 3 (STL3) | | | | | | | | |

| Error Code | Reading | Description |
|--------------|------------------------------------|-------------------------------------------------------------------------------|
| 72 (STL1) | Safety Torque Off (STO) | STO1~SCM1 internal hardware error detected. |
| 76 (STO) | Safety torque output stops(STO) | Safety Torque Off function is enabled while parameter 06-49 is set to 0 or 2. |
| 77 (STL2) | Safety torque loss 2 (STL2) | STO2~SCM2 internal hardware error detected. |
| 78 (STL3) | Safety torque loss 3 (STL3) | STO1~SCM1 and STO2~SCM2 internal hardware error detected. |

Appendix A:

AC Motor Drives EMC Standard Installation Guide

EMC Compliance Practice

Preface

When an AC motor drive is installed in a noisy environment, radiated and/or conducted noise via signal and power cables can interfere with the correct functioning, cause errors or even damage to the drive. To prevent this, some AC motor drives have an enhanced noise resistance but the results are limited and it is not economical. Therefore, an effective method would be finding the cause of the noise and use the right solution to achieve “no emission, no transmission and no reception of noise”. All three solutions should be applied.

Finding the Noise

- Ascertain whether the error is caused by noise.
- Find the source of the noise and its transmission path.
- Confirm the signal and the source of noise

Solutions

- Grounding
- Shielding
- Filtering

Table of Contents

| | |
|-----------------------------------------------------------------|----|
| Preface | i |
| Table of Contents | ii |
| Chapter 1 Introduction | 1 |
| 1.1 What is EMC | 1 |
| 1.2 EMC for AC Motor Drive | 1 |
| Chapter 2 How to prevent EMI | 2 |
| 2.1 Types of EMI: common-mode and differential mode noise | 2 |
| 2.2 How does EMI transmit? (Noise transmission) | 2 |
| Chapter 3 Solution to EMI: Grounding | 4 |
| 3.1 Protective Grounding & Functional Grounding | 4 |
| 3.2 Ground Loops | 5 |
| 3.3 Earthing Systems | 5 |
| Chapter 4 Solution to EMI: Shielding | 9 |
| 4.1 What is Shielding? | 9 |
| 4.2 How to Reduce EMI by Shielding? | 10 |
| Chapter 5 Solution to EMI: Filter | 12 |
| 5.1 Filter | 12 |
| 5.2 Harmonic Interference | 14 |

Chapter 1 Introduction

1.1 What is EMC?

Electromagnetic Compatibility (EMC) is the ability of an electrical device to function properly in electromagnetic environments. It does not emit electromagnetic noise to surrounding equipment and is immune to interference from surrounding equipment. The goal is to achieve high immunity and low emission; these two properties define the quality of EMC. In general, electrical devices react to high and low frequency phenomena. High frequency phenomena are electrostatic discharge (ESD); pulse interference; radiated electromagnetic field; and conducted high frequency electrical surge. Low frequency phenomena refer to mains power harmonics and imbalance.

The standard emission and immunity levels for compliance depend on the installation location of the drive. A Power Drive System (PDS) is installed in an industrial or domestic environment. A PDS in a domestic environment must have lower emission levels and is allowed to have lower immunity levels. A PDS in an industrial environment is allowed to have higher emission levels but must have more severe immunity levels.

1.2 EMC for AC Motor Drive

When an AC motor drive is put into operation, harmonic signal will occur at the AC drive's power input and output side. It creates a certain level of electromagnetic interference to the surrounding electrical devices and the mains power network. An AC motor drive is usually applied in industrial environments with a strong electromagnetic interference. Under such conditions, an AC drive could disturb or be disturbed.

Delta's AC motor drives are designed for EMC and comply with EMC standard EN61800-3 2004. Installing the AC motor drive accurately will decrease EMI influences and ensure long term stability of the electricity system. It is strongly suggested to follow Delta's user manual for wiring and grounding. If any difficulties or problems arise, please follow the instructions and measures as indicated in this EMC Standard Installation Guide.

Chapter 2 How to prevent EMI

2.1 Types of EMI: Common-mode and differential-mode noise

The electromagnetic noise of an AC motor drive can be distinguished into common-mode and differential-mode noise. Differential-mode noise is caused by the stray capacitance between the conducting wires and common-mode noise is caused by the common-mode coupling current path created by the stray capacitance between the conducting wires and ground.

Basically, differential-mode noise has a greater impact to the AC motor drive and common-mode noise has a greater impact to high-sensitivity electronic devices. An excessive amount of differential-mode noise may trigger the circuit protection system of the AC motor drive. Common-mode noise affects peripheral electronic devices via the common ground connection.

EMC problems can be more serious when the following conditions apply:

- When a large horsepower AC motor drive is connected to a large horsepower motor.
- The AC motor drive's operation voltage increases.
- Fast switching of the IGBTs.
- When a long cable is used to connect the motor to the AC motor drive.

2.2 How does EMI transmit? (Noise transmission path)

Noise disturbs peripheral high-sensitivity electrical devices/systems via conduction and radiation, their transmission paths are shown hereafter:

1. Noise current in the unshielded power cable is conducted to ground via stray capacitances into a common-mode voltage. Whether or not other modules are capable to resist this common-mode noise depends on their Common-Mode Rejection Ratio (CMRR), as shown in the following figure.

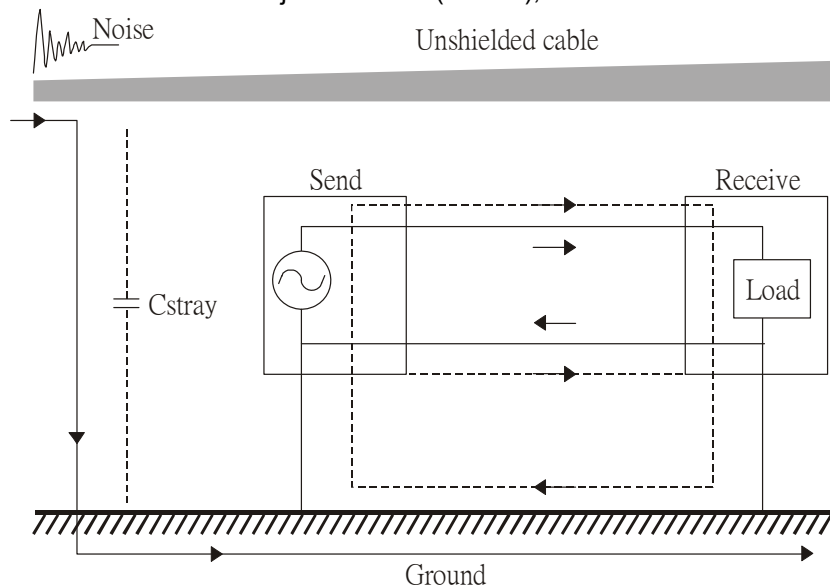

2. Common-mode noise in the power cable is transmitted through the stray capacitance and coupled into the adjacent signal cable, as shown in Figure 2. Several methods can be applied to reduce the effect of this common-mode noise; for example, shield the power cable and/or the signal cables, separate the power and signal cables, take the input and output side of the signal cable and twist them together to balance out the stray capacitance, let power cables and signal cables cross at 90° , etc.

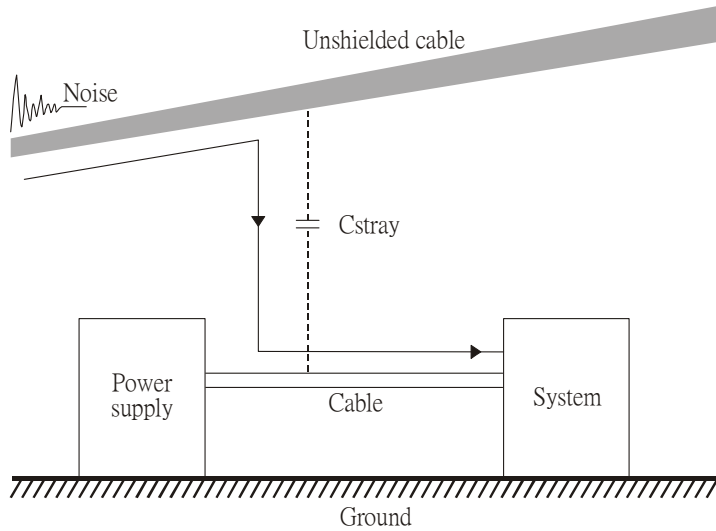

3. Common-mode noise is coupled via the power cable to other power systems then the cable of such a power system is coupled to the transmission system, as shown in Figure 3.

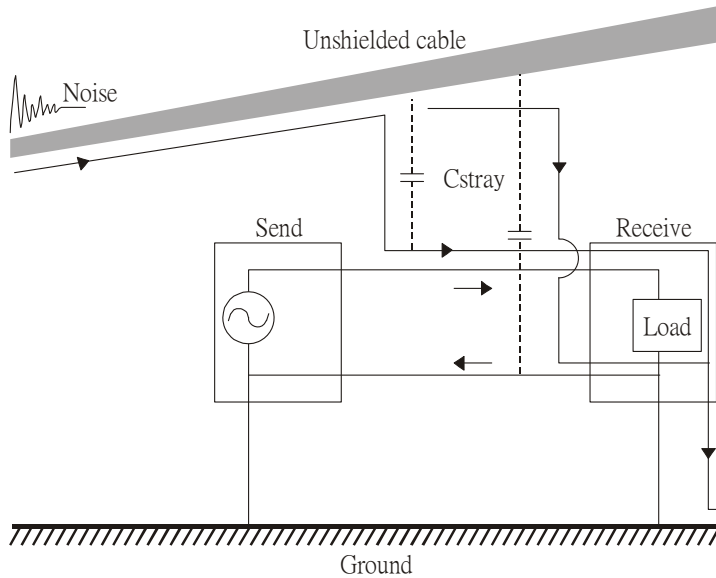

4. The common-mode noise of an unshielded power cable is transmitted to the ground via the stray capacitance. Since both shielded wire and unshielded wire are connected to a common ground, other systems can be interfered with by the common-mode noise that is transmitted from the ground back to the system via the shield. See Figure 4.

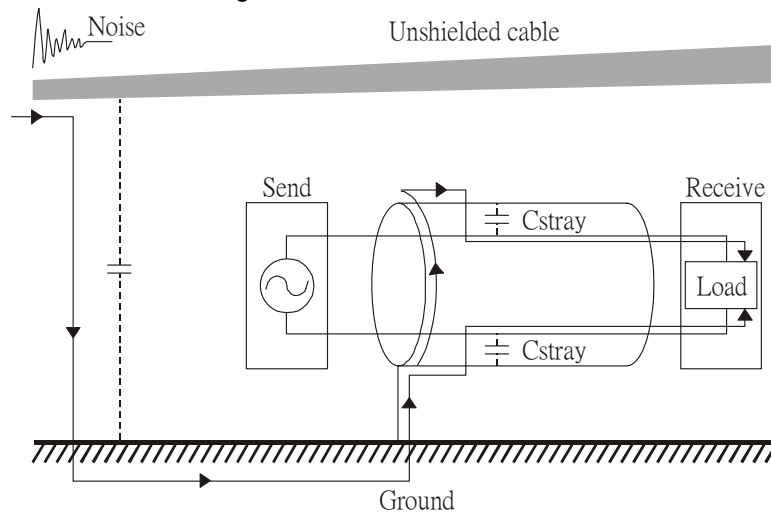

5. When excessive pulse modulated currents pass through an un-grounded AC drive cable, it acts as an antenna and creates radiated interference.

Chapter 3 Solution to EMI: Grounding

The leakage current of an electronic equipment is conducted to ground via the grounding wire and the ground electrode. According to Ohm's law, potential differences may arise when the electrode's ground and the ground's ground resistance are different.

According to Ohm's law, the earth resistance for electrode and the ground are different, in this case potential differences may arise.

3.1 Protective Grounding & Functional Grounding

Please carefully read the following instruction if two types of grounding are applied at the same time.

Protective grounding is applied outside buildings and must have low resistance. On the other hand, functional grounding can be applied inside buildings and must have low impedance.

The goal of EMC is to avoid any interference effects. Grounding for EMC can be distinguished by frequency. For frequencies lower than 10 kHz, a *single-point ground* system should be used and for frequencies higher than 10 kHz, a *multiple point ground* system should be used.

- *Single Point Grounding*: all signal grounds of all IT equipment are connected in series to form a single reference point. This point can be grounded directly to earth; to the designated grounding point or to the safety point that is already grounded.
- *Multiple Point Grounding*: all signals of all IT equipment are grounded independently.
- *Hybrid Grounding*: this type of grounding behaves differently for low and high frequencies. When two pieces of IT equipment (A and B) are connected via a shielded cable, one end is connected directly to ground while the other end is connected to ground via a capacitor. This type of grounding system fulfils the criteria for high and low frequency grounding.
- *Floating grounding*: the signals of all IT equipment are isolated from each other and are not grounded.

DC current flows evenly throughout the conductor section. But AC current flows towards the conductor's surface as frequency increases; this is called the "skin effect". It causes the effective cross-section area to be reduced with increasing frequency. Therefore it is suggested to increase the effective ground cross-section area for high frequencies by replacing pigtail grounding by braided conductors or strip conductors. Refer to the following figure.

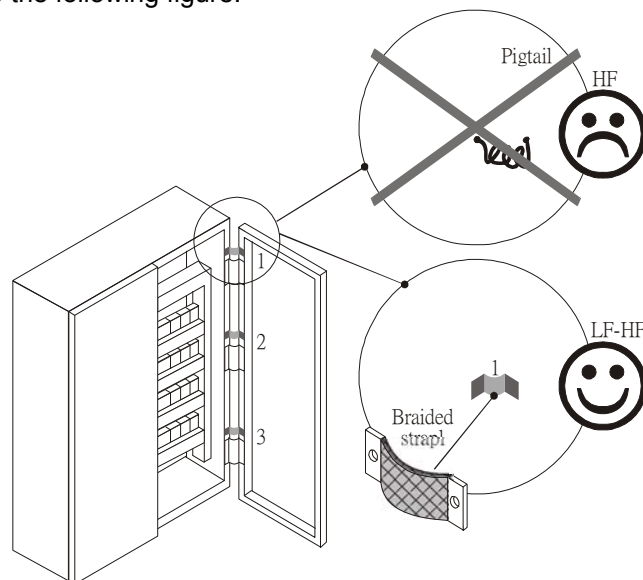

This is why a thick short ground wire must be implemented for connecting to the common grounding path or the ground busbar. Especially when a controller (e.g. PLC) is connected to an AC motor drive, it must be grounded by a short and thick conducting wire. It is suggested to use a flat braided conductor (ex: metal mesh) with a lower impedance at high frequencies.

If the grounding wire is too long, its inductance may interfere structure of the building or the control cabinet and form mutual inductance and stray capacitance. As shown in the following figure, a long grounding wire could become a vertical antenna and turn into a source of noise.

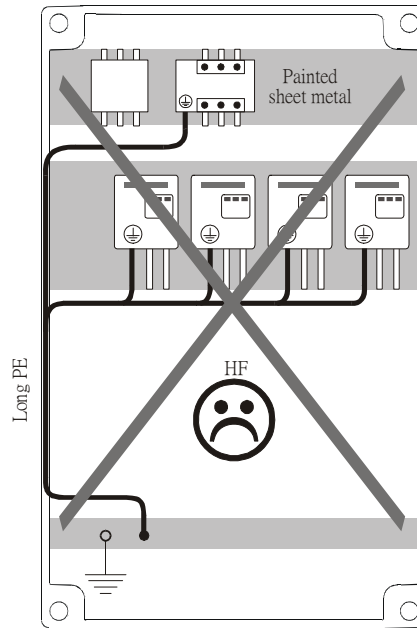

3.2 Ground Loops

A *ground loop* occurs when the pieces of equipment are connected to more than one grounding path. In this case, the ground current may return to the grounding electrode via more than one path. There are three methods to prevent ground loops

1. Use a common power circuit
2. Single point grounding
3. Isolate signals, e.g. by photocouplers

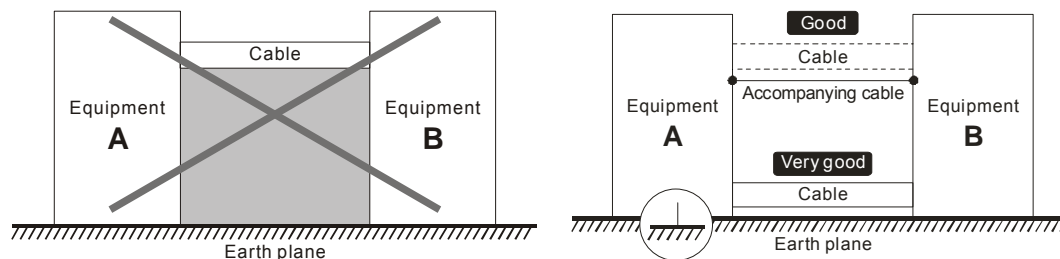

In order to avoid “Common Mode Noise”, please use parallel wires or twisted pair wiring. Follow this rule and also avoid long wires, it is suggested to place the two wires as close to each other as possible.

3.3 Earthing Systems

The international standard IEC60364 distinguishes three different earthing system categories, using the two-letter codes TN, TT, IT.

- The **first letter** indicates the type of earthing for the power supply equipment (generator or transformer).
 - T**: One or more points of the power supply equipment are connected directly to the same earthing point.
 - I**: Either no point is connected to earth (isolated) or it is connected to earth via high impedance.
- The **second letter** indicates the connection between earth and the power supply equipment.
 - T**: Connected directly to earth (This earthing point is separate from other earthing points in the power supply system.)
 - N**: Connected to earth via the conductor that is provided by the power supply system
- The **third and fourth letter** indicate the location of the earth conductor.
 - S**: Neutral and earth conductors are separate
 - C**: Neutral and earth are combined into a single conductor

TN system

TN: The neutral point of the low voltage transformer or generator is earthed, usually the star point in a three-phase system. The body of the electrical device is connected to earth via this earth connection at the transformer.

protective earth (PE): The conductor that connects the exposed metallic parts of the consumer.

neutral (N): The conductor that connects to the start point in a 3-phase system or that carries the return current in a single phase system.

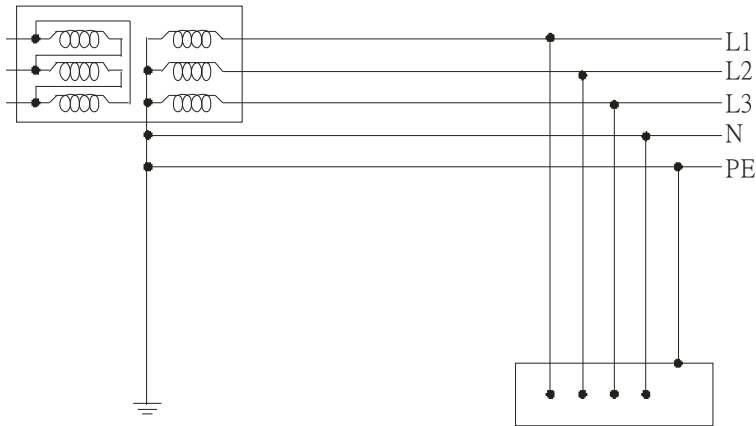

TN-S system

TN-S: PE and N are two separate conductors that are combined together only near the power source (transformer or generator). It is the same as a three-phase 5-wire system.

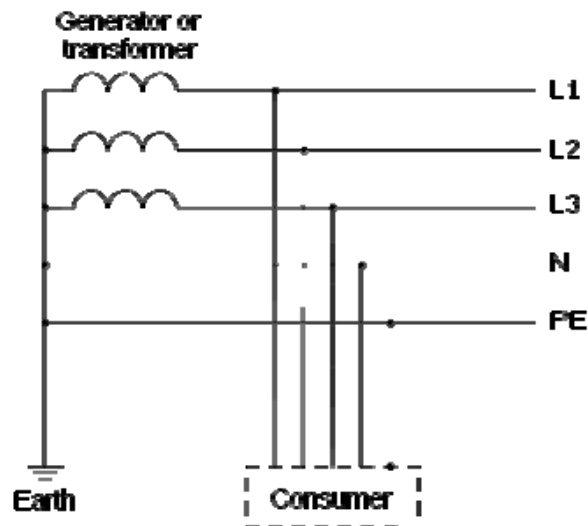

TN-C system

TN-C: PE and N are two separate conductors in an electrical installation similar to a three-phase 5 wire system, but near the power side, PE and N are combined into a PEN conductor similar to a three-phase 4 wire system.

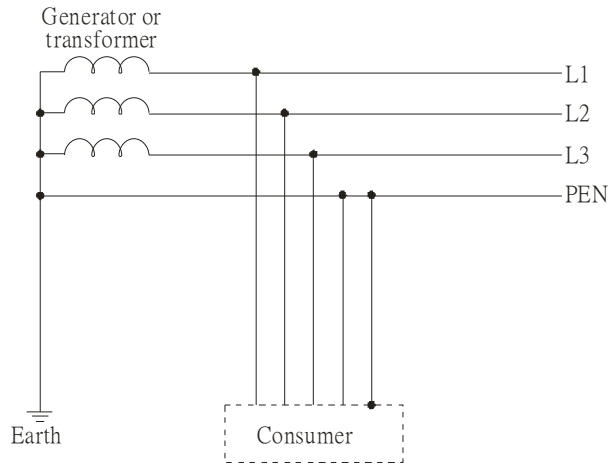

TN-C-S system

TN-C-S: A combined earth and neutral system (PEN conductor) is used in certain systems but eventually split up into two separate conductors PE and N. A typical application of combined PEN conductor is from the substation to the building but within the building PEN is separated into the PE and N conductors. Direct connection of PE and N conductors to many earthing points at different locations in the field will reduce the risk of broken neutrals. Therefore this application is also known as *protective multiple earthing (PME)* in the UK or as *multiple earthed neutral (MEN)* in Australia

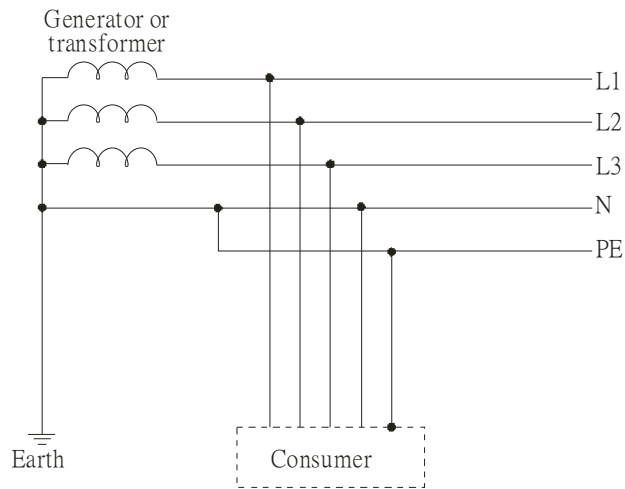

TT system

TT: The neutral point (N) of the low voltage transformer and the equipment frames (PE) are connected to a separate earthing point. The Neutral (N) of the transformer and electrical equipment are connected.

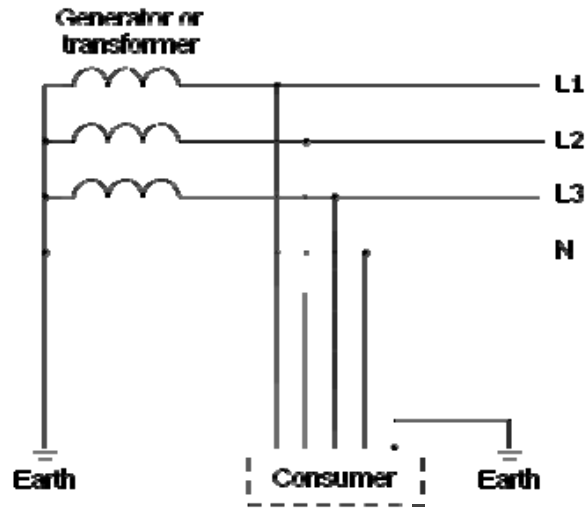

IT system

IT: The neutral point of the transformer and electrical equipment are not earthed, only the equipment frames PE are earthed.

In the IT network, the power distribution system Neutral is either not connected to earth or is earthed via high impedance. In such a system, an insulated monitoring device is used for impedance monitoring. A built-in filter should be disconnected by the RFI-jumper and an external filter should not be installed

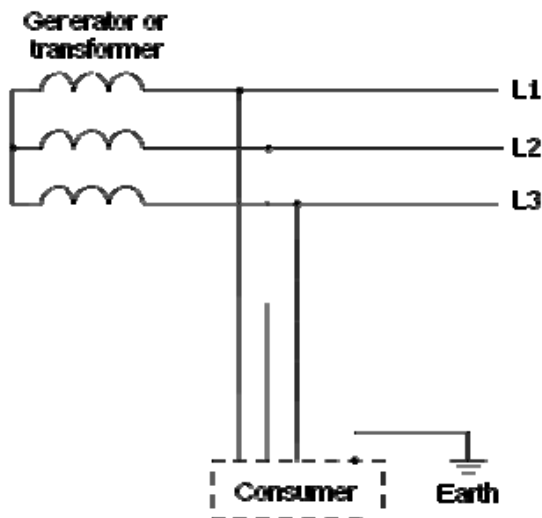

when the AC motor drive or the AC servo motor drive is connected to an IT system.

Criteria for earthing system and EMC

| | TN-S | TN-C | TT | IT |
|---------------------|----------------------------------------------------------------------------|----------------------------------------------------------------------------|------------------|----------------------------------------------------------------------------|
| Safety of Personnel | Good | Good | Good | Good |
| | Continuity of the PE conductor must be ensured throughout the installation | Continuity of the PE conductor must be ensured throughout the installation | RCD is mandatory | Continuity of the PE conductor must be ensured throughout the installation |

| | | | | |
|-------------------------------|--------------------------------------------------------------------------------------------------------------------------------------------------------------------------------------------|------------------------------------------------------------------------------------------------------------------------------------------------------------------------------------------------------------------------------|----------------------------------------------------------------------------------------------------------------------------------------------------------------------------------------------|------------------------------------------------------------------------------------------------------------------------------------------------------------------------------------------------------------------------------------------------------------------------------------------|
| Safety of property | Poor High fault current (around 1kA) | Poor High fault current (around 1kA) | Good Medium fault current (< a few dozen amperes) | Good Low current at the first fault (< a few dozen mA) but high current at the second fault |
| Availability of energy | Good | Good | Good | Excellent |
| EMC behavior | Excellent Few equipotential Problems: - Need to handle the high leaking currents problem of the device - High fault current (transient disturbances) | Poor (prohibited) - Neutral and PE are the same - Circulation of disturbance currents in exposed conductive parts (high magnetic-field radiation) - High fault currents (transient disturbances) | Good - Over-voltage risk - Equipotential Problems: - Need to handle the high leaking currents problem of the device - RCD (Residual-current device) | Poor (should be avoided) - Over-voltage risk - Common-mode filters and surge arrestors must handle the phase to phase voltage. - RCDs subject to nuisance tripping when common-mode capacitors are present - Equivalent to TN system for second fault |

Chapter 4 Solution to EMI: Shielding

4.1 What is Shielding?

Electrostatic shielding is used to isolate equipment so that it will not create electromagnetic field interference or be influenced by an external electromagnetic field. A conductive material is used for electrostatic shielding to achieve this isolation.

A *Faraday cage* can be made from a mesh of metal or a conductive material. One characteristic of metal is that it is highly conductive and not electrostatic, which offers shielding and prevents interference by external electrical fields. Metal with its high conductivity protects the internal devices from high voltages—no voltage will enter the cage even when the cage is experiencing a high current. In addition, electromagnetic fields can also pass through the Faraday cage without causing any disturbance.

Electromagnetic shielding is applied to some electrical devices and measurement equipment for the purpose of blocking interference. Examples of shielding include:

- earth high-voltage indoor equipment using a metal frame or a high-density metal mesh
- shielding a power transformer is achieved by wrapping a metal sheet between the primary and secondary windings or by adding an enamel wire to the winding wire which is then earthed.
- a shielding coating, which is made of metal mesh or conductive fibers to provide effective protection for the workers who work in a high-voltage environment.

In the picture below, the radio appears to be not fully covered by metal but if the conductivity of the metal is high, radio waves are completely blocked and the radio will not receive any signal.

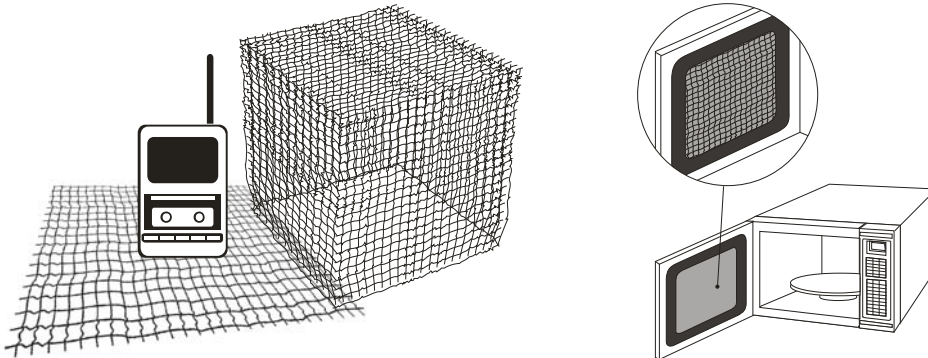

Mobile phone connections are also established through the transmission of radio waves. This is why the mobile phone reception is often cut off when we walk into an elevator. The metal walls of the elevator create the same shielding effect just as if we had entered a metal cage. Another example is a microwave oven. The microwave door may seem transparent in visible light, but the density of the metal mesh in the microwave door blocks the electromagnetic waves. A higher density of the metal mesh offers better shielding.

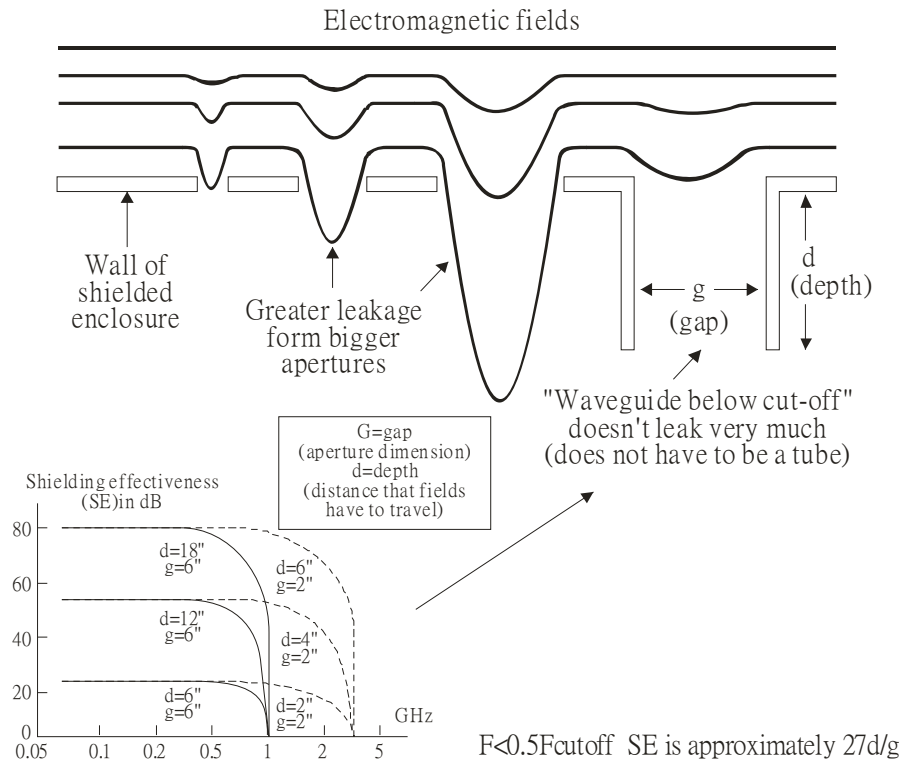

4.2 How to reduce EMI by Shielding?

Iron and other metals are high conductivity materials that provide effective shielding at extremely low frequencies. But conductivity will decrease as:

1. High frequency signals are applied to the conductor.
2. Equipment is located in a strong magnetic field
3. The shielding frame is forced into a specific form by machines.

It is difficult to select a suitable high-conductivity material for shielding without the help from a shielding material supplier or a related EMI institution.

Metallic Shielding Effectiveness

Shielding Effectiveness (SE) is used to assess the applicability of the shielding shell. The formula is:

$$SE_{dB} = A + R + B \text{ (Measures in dB)}$$

where A= Absorption loss (dB)

R= Reflection loss (dB)

B= Correction factor (dB) (for multiple reflections in thin shields)

The absorption loss refers to the amount of energy loss as the electromagnetic wave travels through the shield. The formula is:

$$AdB = 1.314(f\sigma\mu)^{1/2}t$$

where f= frequency (MHz)

μ = permeability relative to copper

σ = conductivity relative to copper

t= thickness of the shield in centimeters

The reflection loss depends on the source of the electromagnetic wave and the distance from that source. For a rod or straight wire antenna, the wave impedance increases as it moves closer to the source and decreases as it moves away from the source until it reaches the plane wave impedance (377) and shows no change. If the wave source is a small wire loop, the magnetic field is dominant and the wave impedance decreases as it moves closer to the source and increases as it moves away from the source; but it levels out at 377 when the distance exceeds one-sixth of the wavelength.

Electrical Cabinet Design

In a high frequency electric field, shielding can be achieved by painting a thin layer of conductive metal on the enclosure or on the internal lining material. However, the coating must be thorough and all parts should be properly covered without any seams or gaps (just like a Faraday cage). That is only the ideal. Making a seamless shielding shell is practically impossible since the cage is composed of metal parts. In some conditions, it is necessary to drill holes in the shielding enclosure for installation of accessories (like optional cards and other devices).

1. If the metallic components are properly welded using sophisticated welding technology to form an electrical cabinet, deformation during usage is unlikely to occur. But if the electrical cabinet is assembled with screws, the protective insulating layer under the screw must be properly removed before assembly to achieve the greatest conductivity and best shielding.
2. Drilling holes for the installation of wires in the electrical cabinet lowers the shielding effectiveness and increases the chance of electric waves leaking through the openings and emitting interference. We recommend that the drilled holes are as narrow as possible. When the wiring holes are not used, properly cover the holes with metal plates or metal covers. The paint or the coating of the metal plate and metal cover should be thoroughly removed to ensure a metal-to-metal contact or a conductive gasket should be installed.
3. Install industrial conductive gaskets to completely seal the electrical cabinet and the cabinet door without gaps. If conductive gaskets are too costly, please screw the cabinet door to the electrical cabinet with a short distance between the screws.
4. Reserve a grounding terminal on the electrical cabinet door. This grounding terminal shall not be painted. If the paint already exists, please remove the paint before grounding.

Electrical wires and cables

Shielded Twisted Pair (STP) is a type of cable where two insulated copper wires are twisted together with a metal mesh surrounding the twisted pair that forms the electromagnetic shielding and can also be used for grounding.

The individual electrical wires and complete cable are surrounded by (synthetic) rubber that provides insulation and also protects against damage.

There are two types of electrical cables: high voltage and low voltage. The high voltage cable differs from the low voltage cable in that it has an additional insulation layer called the dielectric insulator within the plastic sleeve. The dielectric insulator is the most important component in insulation. The low voltage cable is usually only filled with a soft polymer material for keeping the internal copper wire in place.

The shield has two functions.

1. To shield the electrical wire and cable.
 - A. Electric currents increase as power flows through the power cable and generate an electrical field. Such interference can be suppressed inside the cable by shielding the power cables or the electrical wires.
 - B. To form a protective earthing. When the cable core is damaged, the leakage current will flow via the shield to ground
2. To protect the cable. A power cable used for the computer control purpose generates only relatively low amount of current inside the cable. Such power cable will not become the source of interferences but has great possibility to be interfered by the surrounding electrical devices.

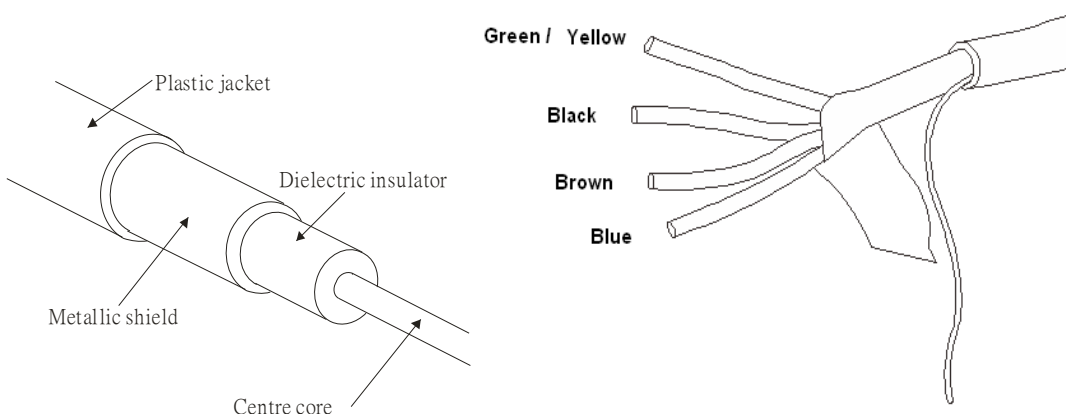

Chapter 5 Solution to EMI: Filter

5.1 Filter

Electromagnetic interference is transmitted in two ways, by radiation and by conduction. The most effective and economical method of reducing radiated interference is to use shielding and of reducing conducted interference is to use an electromagnetic filter.

Noise interference can be divided into two categories: high frequency (150kHz~300MHz) and low frequency (100Hz~3000Hz). High-frequency noise fades more over distance and has a shorter wave-length, while low-frequency noise fades less over distance and has a longer wave-length. Both types of interference are transmitted through power cables and power leads, affecting the power supply side.

High-frequency interference at the power side can be eliminated or attenuated by mounting a filter. The filter consists of coils and capacitors. Some drives do not have a built-in filter, in which case the installation of an external option filter is required. The drawing below shows a standard filter diagram:

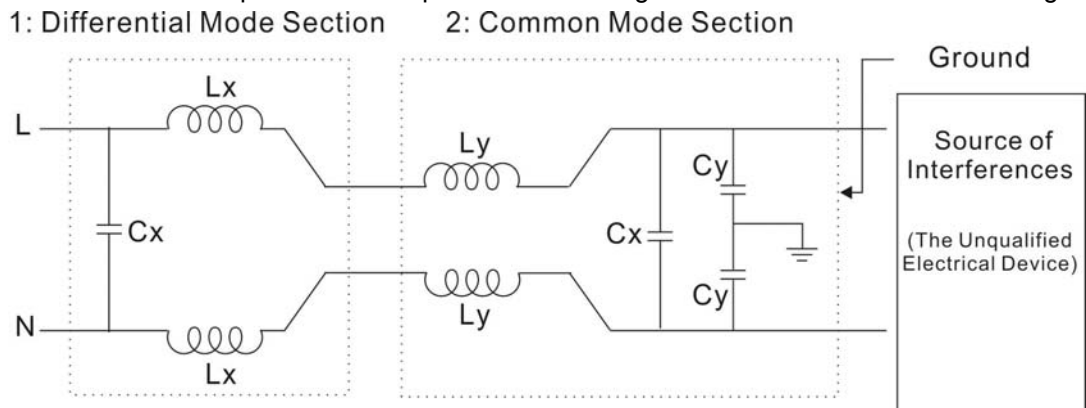

A filter is composed of a Differential Mode section (to eliminate noise below 150 kHz) and a Common Mode section (to eliminate noise above 150 kHz). For high-frequency noise, the inductor acts as a high impedance to form an open circuit and the capacitor acts as a low impedance to form a short circuit. Proper design and dimensioning of inductors and capacitors give a resonant circuit to absorb harmonic currents. Capacitor C_y is earthed to lead the harmonic currents to the ground.

External Filter

The filter and the AC drive should be installed in the control cabinet or on the mounting plate that is earthed to ground. The motor cable must be shielded and as short as possible. Please use the filters recommended by Delta to ensure compliance with EMC standards.

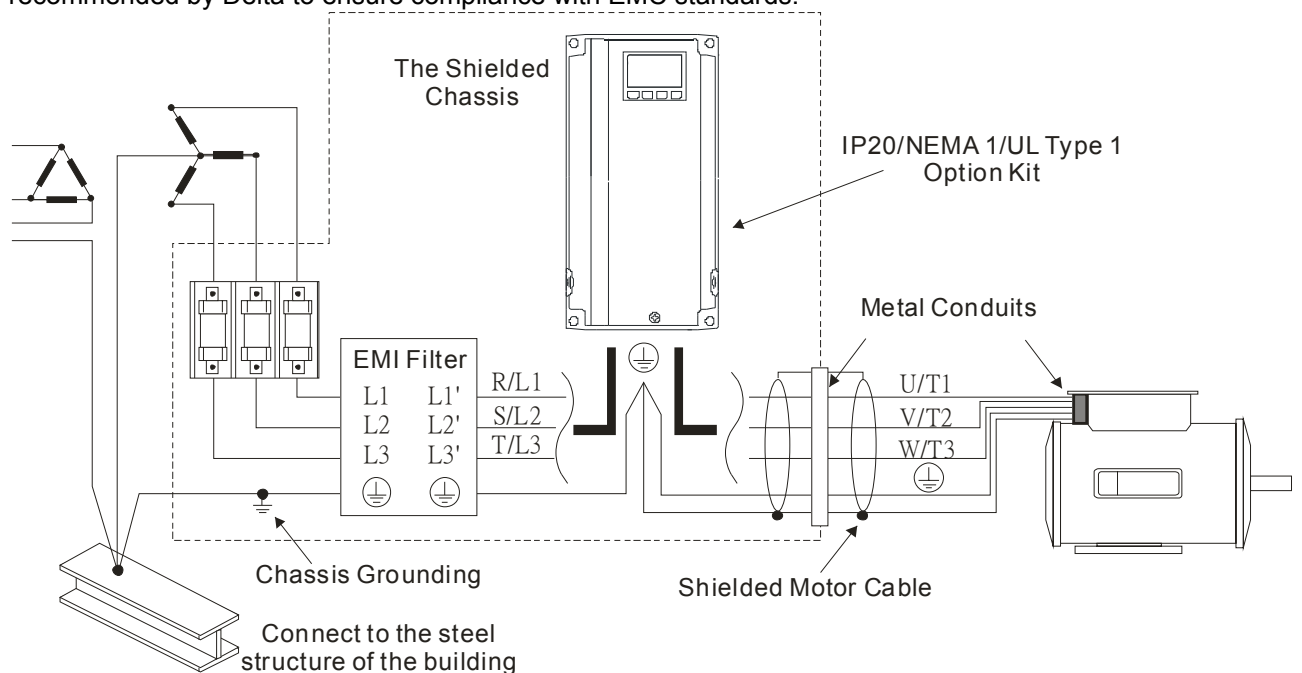

AC Motor Drives with Built-in Filter

1. Since interferences are suppressed by installing an earthed capacitor in the filter, the amount of current to ground (leakage current) could result in electric shocks to personnel or the power system. Please be aware of this problem.
2. Since the leakage current to ground can be high, it is crucial to implement protective earthing to prevent electrical shocks.

Filter Installation (With and Without)

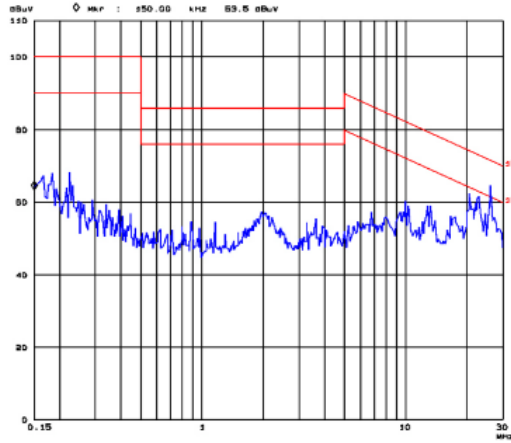

<15m@60Hz with EMI Filter>

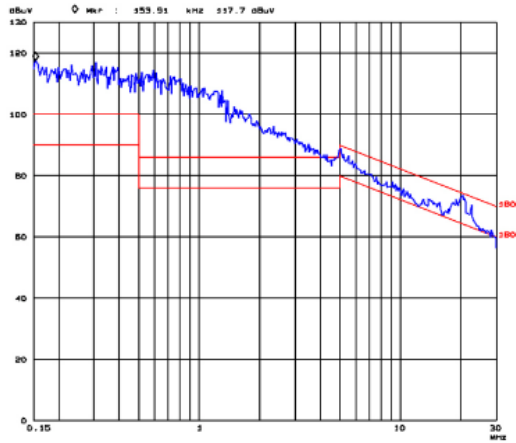

<15m@60Hz without EMI Filter>

Zero Phase Reactor (Choke)

Interferences can also be suppressed by installing a zero phase reactor at the power supply side and/or the AC Motor Drive's output, depending on where the interference is. Since currents are large at the power input and the AC Motor Drive's output, please carefully select the magnetic core with suitable current handling capability. An ideal magnetic material for large currents is compound magnetic powder. It has a higher current handling capability and higher impedance compared to pure metallic magnetic cores. It is therefore suitable to implement in a high frequency environment. The impedance can also be enhanced by increasing the turn ratio.

Zero Phase Reactor Installation

There are two installation methods, depending on the size of the zero phase reactor and the motor cable length.

1. Wind the motor cable through the middle of a zero-phase reactor 4 times. Place the reactor and the AC Motor Drive as close to each other as possible.

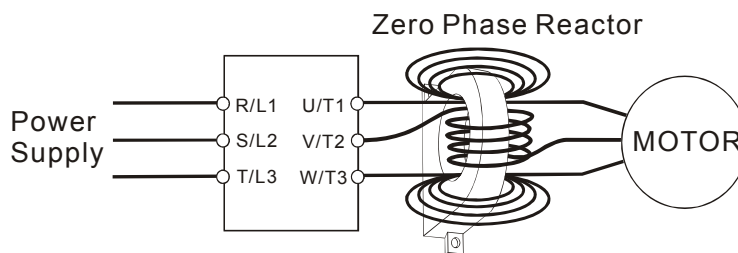

2. Place all wires through the middle of four zero-phase reactors without winding.

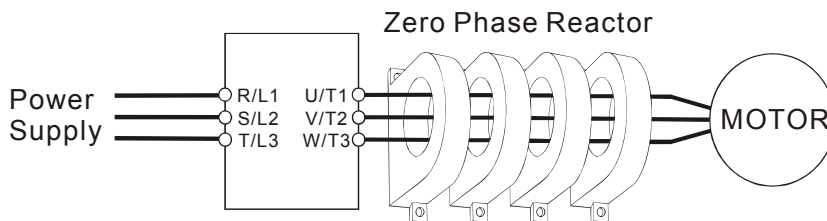

Analog Input Signals

If the analog input signals are affected by noise from the AC motor drive, please connect a capacitor and a ferrite core as indicated in the following diagram. Wind the wires around the core in same direction for 3 times or more.

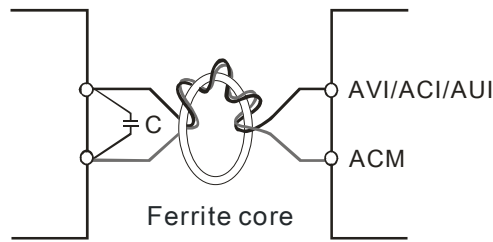

5.2 Harmonic Interference

The AC motor drive's input current is non-linear, the input rectifier generates harmonics. Harmonics must be limited to within a certain range to avoid impact the mains power and to avoid current distortion to ensure surrounding devices are not influenced. An AC Motor Drive with built-in DC reactor suppresses harmonic currents (Total Harmonic Current Distortion THID) effectively and therefore reduces the harmonic voltage peaks (Total Harmonic Voltage Distortion).

Harmonic Current at the Power Supply Side

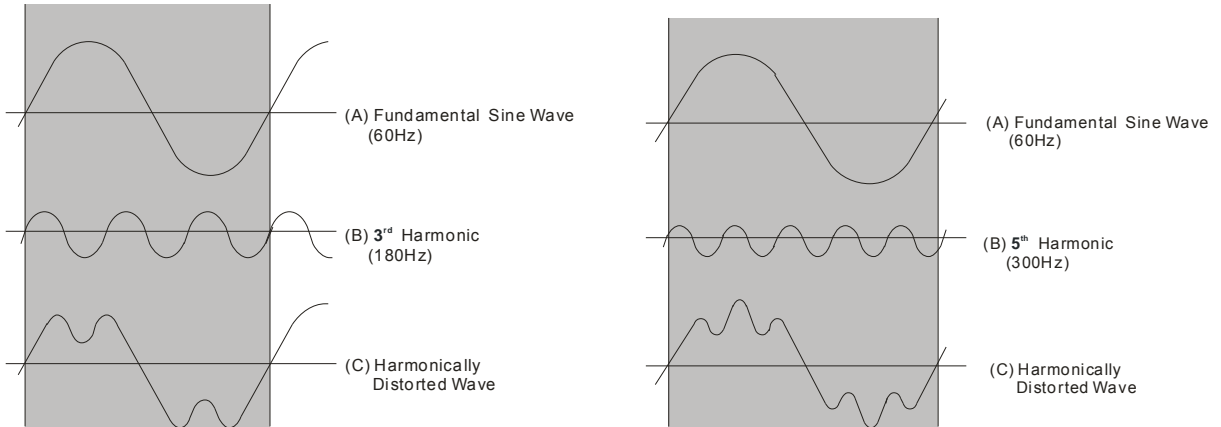

Suppression of Harmonic Currents

When a large portion of lower order harmonic currents (5th, 7th, 11th etc) occur at the power input, surrounding devices will be disturbed and the power factor will be low as a result of reactive power. Installing a reactor at the AC Motor Drive's input effectively suppresses lower order harmonic currents.

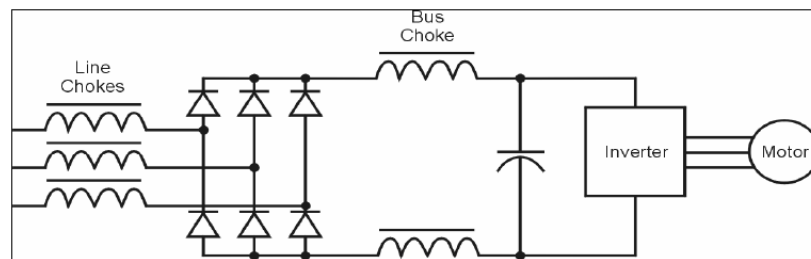

AC Reactor

Installed in series with the power supply and is effective in reducing low order current harmonics. Features of an AC reactor include:

1. Reduces the harmonic currents to the AC Motor Drive and increases the impedance of the power supply.
2. Absorbs interferences generated by surrounding devices (such as surge voltages, currents, and mains surge voltages) and reduce their effect on the AC Motor Drive.
3. Increases the power factor.

DC Reactor

A DC-Reactor is installed between the rectifier and the DC-bus capacitor to suppress harmonic currents and to achieve a higher power factor.

Current Wave Diagrams

